

Standalone Digital Video Recorder

Premium DVR 4, 8, 16 Channel Models

User`s Manual



MADE IN KOREA

FCC Compliance Statement

Notice to Users: This equipment has been tested and found to comply with the limits for a Class A digital device. Pursuant to Part 15 of the FCC Rules, these limits are designed to provide reasonable protection against harmful interference when the equipment is operated in a commercial environment. This equipment generates uses and can radiate radio frequency energy and, if not installed and used in accordance with the instruction manual, may cause harmful interference to radio communications. Operation of this equipment in a residential area is likely to cause harmful interference in which case the user will be required to correct the interference at own expense.

CAUTION

CHANGES OR MODIFICATIONS NOT EXPRESSLY APPROVED BY THE PARTY RESPONSIBLE FOR COMPLIANCE COULD VOID THE USER'S AUTHORITY TO OPERATE THE EQUIPMENT.

ATTENTION

DES CHANGEMENTS OU DES MODIFICATIONS NON EXPRESSEMENT APPROUVEES PAR LE RESPONSABLE DE LA CONFORMITE POURRAIENT ANNULER L'AUTORISATION DE L'UTILISATEUR A EXPLOITER L'EQUIPEMENT.

The equipment complies with the requirement of FCC CFR 47 PART 15 SUBPART B, Class A.

Explanation of Graphical Symbols



This symbol indicates the presence of important operating and maintenance (servicing) instruction in the literature accompanying the product.

Ce symbole indique la présence d'instructions importantes et de maintenances dans le manuel accompagnant le produit



This symbol indicates the presence of non-insulated "dangerous voltage" within the product's enclosure that may be of sufficient magnitude to constitute a risk of electric shock to persons.

Ce symbole indique la présence de « haute tension » non-isolé dans le produit qui peut avoir pour conséquence un risque de la décharge électrique aux personnes.

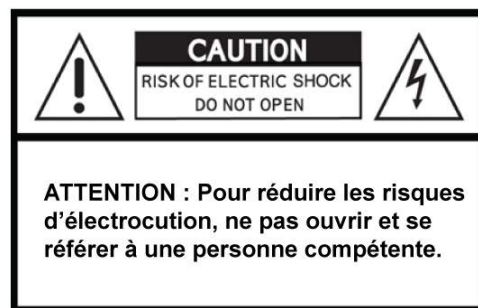
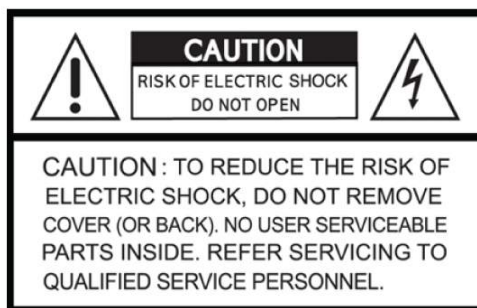

Warnings

- Installation and servicing should be performed only by qualified and experienced personnel.
- Power off the DVR when connecting cameras, audio, or sensor cables.
- The manufacturer is not responsible for any damage caused by improper use of the product or failure to follow instructions for the product.
- The manufacturer is not responsible for any problems caused by or resulting from the user physically opening the DVR for examination or attempting to fix the unit.
- The manufacturer may not be held liable for any issues with the unit if any labels are removed in the product.

Cautions

- This product has free voltages (100V ~ 240V). See installation instructions before connecting to the power supply.
- This product uses a Lithium battery.
- To avoid any risk of explosion, do not replace the battery on the main board by anything other than a Lithium battery.
- Dispose of used batteries according to the manufacturer's instructions.
- This equipment and all communication wirings are intended for indoor use only.
- To reduce the risk of fire or electric shock, do not expose the unit to rain or moisture.

WEEE(Waste Electrical and Electronic Equipment)

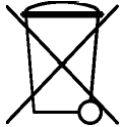

Customers in European Union countries are advised to dispose this product, at the end of its useful life, as per applicable local laws, regulations and procedures.

Important Safeguards

1. Read Instructions

- To reduce the risk of fire or electric shock, do not expose the unit to rain or moisture.

2. Retain Instructions

- The safety and operating instructions should be retained for future reference.

3. Cleaning

- Unplug this equipment from the wall outlet before cleaning it. Do not use liquid aerosol cleaners. Use a damp soft cloth for cleaning.

4. Attachments

- Never add any attachments and/or equipment without manufacturer approval as such additions may result in the risk of fire, electric shock, or other personal injury.

5. Water and/or Moisture

- Do not use this equipment near water or in contact with water.

6. Accessories

- Do not place this equipment on an unstable cart, stand or table. The equipment may fall, causing serious injury to a child or adult and serious damage to the equipment.
- Wall or shelf mounting should follow the manufacturer's instructions and should use a mounting kit approved by the manufacturer.



- Move this equipment and cart combination with care. Quick stops, excessive force and uneven surfaces may cause the equipment and cart combination to overturn.

7. Power Sources

- This equipment should be operated only from the type of power source indicated on the marking label. If not sure the type of power, please consult to distributor or local power company.
- UPS (Uninterruptible Power Supply) is highly recommended when the power input is not stable to protect DVR and HDD(s).

8. Power Cords

- Operator or installer must remove power, BNC, alarm and other connections before moving the equipment.

9. Lightning

- For added protection for this equipment during a lightning storm, or when it is left unattended and unused for long periods of time, unplug it from the wall outlet and disconnect the antenna or cable system. This will prevent damage to the equipment due to lightning and power-line surges.

10. Overloading

- Do not overload wall outlets and extension cords to avoid the risk of fire or electric shock.

11. Objects and Liquids

- Never push objects of any kind through openings of this equipment as they may touch dangerous voltage points or short out parts that could result in a fire or electric shock.
- Never spill liquid of any kind on the equipment.

12. Servicing

- Do not attempt to service this equipment yourself. Refer all servicing to qualified service personnel.

13. Damage Requiring Service

- Unplug this equipment from the wall outlet and refer servicing to qualified service personnel under the following conditions:
 - ① When the power-supply cord or the plug has been damaged.
 - ② If liquid is spilled or objects have fallen into the equipment.
 - ③ If the equipment has been exposed to rain or water.
 - ④ If the equipment does not operate normally by following the operating instructions, adjust only those controls that are covered by the operating instructions as an improper adjustment of other controls may result in damage and will often require extensive work by a qualified technician to restore the equipment to its normal operation.
 - ⑤ If the equipment has been dropped or damaged the cabinet.
 - ⑥ When the equipment exhibits a distinct change in performance—this indicates a need for service.

14. Replacement Parts

- When replacement parts are required, ensure the service technician uses replacement parts specified by the manufacturer or that have the same characteristics as the original part. Unauthorized substitutions may result in fire, electric shock, or other hazards.

15. Safety Check

- Upon completion of any service or repairs to this equipment, ask the service technician to perform safety checks to determine that the equipment is in proper operating condition.

16. Field Installation

- This installation should be made by a qualified service person and should conform to all local codes.

17. Correct Batteries

CAUTION

RISK OF EXPLOSION IF BATTERY IS REPLACED BY AN INCORRECT TYPE.
DISPOSE OF USED BATTERIES ACCORDING TO THE INSTRUCTIONS

ATTENTION

RISQUE D'EXPLOSION SI LA BATTERIE EST REMPLACÉE PAR UN TYPE INCORRECT
DISPOSEZ DE BATTERIES EN ACCORS AVEC LES INSTRUCTIONS

18. Operating Temperature

- An operating temperature range is specified so that the customer and installer may determine a suitable operating environment for the equipment.

19. Elevated Operating Ambient Temperature

- If installed in a closed or multi-unit rack assembly, the operating ambient temperature of the rack environment may be greater than room ambient. Therefore, consideration should be given to installing the equipment in an environment compatible with the specified operating temperature range.

20. Reduced Air Flow

- Installation of the equipment in the rack should be such that the amount of airflow required for safe operation of the equipment is not compromised.

21. Mechanical Loading

- Mounting of the equipment in the rack should be such that a hazardous condition is not caused by uneven mechanical loading.

22. Circuit Overloading

- Consideration should be given to connection of the equipment to supply circuit and the effect that overloading of circuits might have on over-current protection and supply wiring. Appropriate consideration of equipment nameplate ratings should be used when addressing this concern.





23. Grounding (Earthing)

- Connection of ground wire is highly recommended to protect the DVR from external electric shock, such as lightning, electrical surge.

WARNING

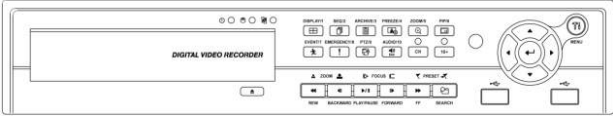
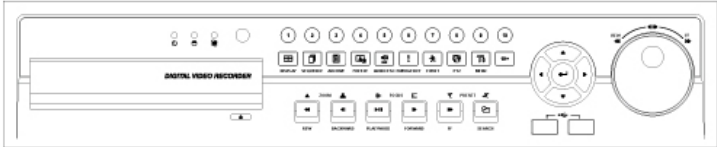
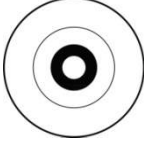
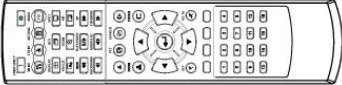
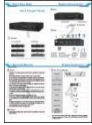
WARRANTY IS VOID IF SEAL OR LABEL IS REMOVED OR DAMAGED.

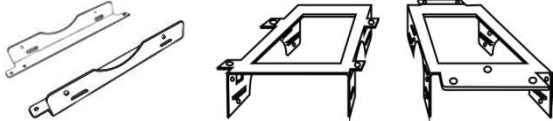
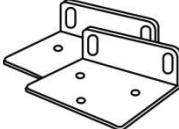
The List of Configuration

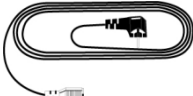
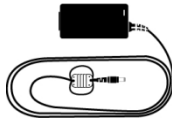
<p>DVR Set</p>	<p>S (4, 8 CH), A and E (4CH) Type : 4 / 8 / 16CH</p>  <p>B and E (8, 16CH) Type : 4 / 8 / 16CH</p>  <p>C, D, F, G, H, I and J (8, 16CH) Type : 4 / 8 / 16CH</p> 
<p>Manual / CMS CD</p>	
<p>Remote Controller</p>	
<p>Quick Guide</p>	
<p>Screws</p>	
<p>HDD Brackets</p>	
<p>Rack Bracket (Except S, A, B and E Type)</p>	
<p>Data Cable</p>	
<p>Power Cable</p>	
<p>Adapter (Except G 8/16CH Type)</p>	

Mandatory Setup & Operation Precautions

● STEP 1. Date / Time Configuration ('before' HDD(s) installation)

- Plug a network cable, if any.
- Turn on the DVR and press 'OK' on no HDD(s) detection message.
- Go to **SETUP>SYSTEM>General>Setup**.
- Check on 'NTP Setup' box, and then select your 'Time Zone'.
- Select DST (Daylight Saving Time) 'On' or 'Off' accordingly.
- When the DVR has no internet connection, adjust Date/Time manually. Otherwise the DVR will adjust the correct time every hour automatically.
- Click/Select 'EXIT' on your right and top corner.
- Turn off the DVR for Step 2 (HDD(s) installation).

● STEP 2. HDD(s) Installation / Addition / Moving / Replacement / Removal

- **HDD(s) Installation/Addition:** Make sure the DVR is turned off. Connect a power cable and a SATA cable from DVR's main board to HDD(s). Use SATA port #1 (written on the board) for the first HDD and in order. Power the DVR on and follow the screen. DVR starts recording. No rebooting required.
- **HDD(s) Removal:** Make sure the DVR is turned off. Disconnect a power and a SATA cable from DVR's main board to HDD(s). Power the DVR on and follow the screen. (You may leave SATA port #1 unused when you removed the attached #1 HDD.)
- **HDD(s) Selection:** Even most of HDDs are compatible with DVRs; suggested HDD list is available by request.

● Power Off

- Do not turn DVR off, or plug off the power adapter while DVR is in operations (record/playback). It may cause permanent damage to the equipment. Please Click (←) **Shutdown** on System Menu Bar and then **UNPLUG** the power cable after DVR is shut down completely. It is safe to wait for 5 seconds before turning the power on again. ('Shut Down' by DVR's menu selection does NOT physically power off the machine. Please physically unplug the power cable from the DVR to completely turn off.)
- Do not turn off External storage device (e.g., USB memory stick (powered), removable external hard disk, and similar) while the DVR is on. It may cause permanent damage to the equipment. When you have to turn off external storage device, make sure the DVR is turned off. When you turn those on, turn on external storage first and then DVR. (you may unplug simple USB thumb drive freely unless it is in archiving process)
- Do not turn DVR off, or plug off the power adapter when the DVR is formatting an HDD(s). It may cause permanent damage to the equipment. Make sure the power is "ON" until the formatting of an HDD is completed. (note, a DVR formats HDD(s) in seconds)

● Monitor resolution

- For the best picture display, a DVR's local monitor output has a default resolution of 1920x1080 pixels. If your attached monitor does not support 1080p resolution, and you cannot see any picture, please change the DVR's resolution to the lowest as following.
- The lowest resolution (1024x768) Hot Keys: Use your 'Remote Controller' (It comes with a DVR)
- Press followings in order one by one. **REW>FF>BACKWARD>FORWARD**
- The resolution should be changed to 1024x768.

● Default Password

- For all (DVRs and Software) default password is 1111 (four 1(one)s).
- For your protection, it is strongly recommended to change. Computer-like passwords are supported.

● Upgrade

- You may upgrade a DVR when the HDDs are added properly.
- Contact your dealer/technical support when you need a help on updating.

Table of Contents

1. PRODUCT FEATURES	11	4.3.5 Camera	53
1.1 Unpacking	11	4.3.6 Audio	54
1.2 Service	11	4.3.7 Text-In	54
1.3 System Connection Diagram	11	4.4 RECORD	54
2. INSTALLATION	24	4.4.1 Record	54
2.1 Hard disk and DVD-RW Installation	24	4.4.2 Schedule	59
2.1.1 SATA Port	24	4.4.3 Motion	60
2.1.2 Internal SATA Storage	25	4.5 RELAY	60
2.1.3 e-SATA External Storage	25	4.5.1 ALARM IN	61
2.1.4 HDD Installation	25	4.5.2 MOTION	61
2.1.5 HDD Capacity	25	4.5.3 EMERGENCY	62
2.1.6 DVD-RW Installation	25	4.5.4 TEXT-IN	63
2.2 Connector Wiring	26	4.5.5 VIDEO LOSS	63
2.2.1 Video-In/Loop Out Connections	26	5. OPERATION INSTRUCTION	65
2.2.2 HD-SDI Input Signal detection	26	5.1 Viewing	65
2.2.3 Monitor Connections	26	5.1.1 First Image	65
2.2.4 HDMI connections	27	5.1.2 View Format	66
2.2.5 Audio Connections	27	5.1.3 Digital Zoom	66
2.2.6 TCP/IP (Ethernet) Connections	27	5.1.4 Freeze Live Image	66
2.2.7 Alarm Connections (TTL)	27	5.1.5 Pan / Tilt / Zoom Control	67
2.2.8 Master Alarm	28	5.1.6 System Log	68
2.2.9 Alarm Connections (Relay)	28	5.1.7 Key Lock	68
2.2.10 RS-485/422 Connections	28	5.1.8 Emergency Recording	68
2.2.11 RS-485 Over Coax Connection	28	5.1.9 Alarm Out Control and Acknowledge	68
2.2.12 USB Connections	28	5.2 Playback	69
2.2.13 Grounding (Earthing)	28	5.2.1 Search	70
2.2.14 Factory Reset Switch	28	5.2.2 Digital Zoom in Playback	72
2.2.15 Power Supply connections	28	5.2.3 One-touch Playback	72
2.2.16 Connections Guideline	29	5.3 Menu Bar	72
3. INPUT DEVICE AND SCREEN ICONS	30	5.4 Bookmark	73
3.1 Key and LEDs	30	5.5 Archive	73
3.2 Camera Select Keys for 16 Channel DVR	32	6. CMS PRO	76
3.3 Front Panel	33	6.1 CMS Pro Features	76
3.4 Using a Remote Controller	33	6.1.1 Introduction	76
3.5 Using a Mouse	34	6.1.2 Features	76
3.6 Screen Icon	35	6.1.3 System Requirements	76
4. SETUP	36	6.2 Installation	77
4.1 Login	36	6.2.1 Software Installation	77
4.2 SYSTEM	37	6.2.2 Login	78
4.2.1 Status	37	6.3 Menu	79
4.2.2 General	37	6.4 Setup	80
4.2.3 Event	42	6.4.1 Local Setup - Device	80
4.3 DEVICE	44	6.4.2 Device Group Setup	82
4.3.1 Display	44	6.4.3 Local Setup - Environment	83
4.3.2 Network	47	6.4.4 Local Setup - Account	86
4.3.3 Alarm	49	6.4.5 Local Setup - E-map	87
4.3.4 Storage	50	6.4.6 Remote Device Setup	90
		6.4.7 Change Password	91
		6.4.8 Help	91

6.5 View	91	8.1 Program Installation	123
6.5.1 Server List.....	92	8.1.1 System Recommendations	123
6.5.2 Remote Device System Log	92	8.1.2 Program Installation Method	123
6.5.3 Remote Device Event Log	92	8.2 Login	124
6.5.4 CMS System Log.....	93	8.3 Watch Mode.....	124
6.5.5 Health Check.....	93	8.3.1 Login Screen	124
6.5.6 Show All Windows	95	8.3.2 Local Setting.....	125
6.6 Application.....	95	8.3.3 Live	127
6.6.1 Search	95	8.4 Search Mode	130
6.6.2 Exit.....	95	8.4.1 Date/Time Search.....	130
6.7 Live (Live Video Monitoring System).....	96	8.4.2 Event Search	131
6.7.1 Overview	96	8.4.3 POS/ATM.....	132
6.7.2 Live Monitor Menu.....	96	8.5 Disconnection	133
6.7.3 Screen Layout Control.....	102	8.6 Uninstall.....	134
6.7.4 Change Division Display	102	9. CMS WEB CLIENT PRO	136
6.7.5 Sequencing	102	9.1 System Requirements.....	136
6.7.6 Audio Volume Control	103	9.2 Setup and Login.....	136
6.8 Search	103	9.3 Live Display	137
6.8.1 Overview	103	9.4 Search Screen.....	138
6.8.2 Time Bar Search.....	103	9.5 PTZ Control	139
6.8.3 Event Search.....	105	9.6 Capture	140
6.8.4 POS/ATM Search.....	105	10. CMS MOBILE VIEWER.....	142
6.8.5 Thumbnail Search	106	10.1 iPhone / iPad (AVY Viewer HD)	142
6.8.6 Smart Search	106	10.1.1 System Requirements	142
6.9 E-Map	107	10.1.2 Installation	142
6.9.1 Overview	107	10.1.3 Site Registration	143
6.9.2 Controls.....	107	10.1.4 Connection	144
6.9.3 E-map Camera – Instant Playback...	107	10.1.5 Live View (Portrait View)	145
6.9.4 Alarm In/Out Control	108	10.1.6 Live View (Landscape View)	146
6.9.5 Audio	108	10.1.7 PTZ Control.....	146
6.10 Uninstalling CMS Pro	108	10.1.8 Search	147
7. ICMS VIEWER.....	110	10.1.9 Snapshot gallery	148
7.1 System Recommendations	110	10.1.10 Setting	149
7.2 Program Installation	110	10.1.11 Uninstallation	149
7.3 Login	111	10.2 Android Phone (AVY Viewer HD)	150
7.4 Watch Mode	111	10.2.1 System Requirements	150
7.4.1 Log-in Screen	111	10.2.2 Installation	150
7.4.2 Local Setting.....	112	10.2.3 Site Registration	151
7.5 Live View.....	115	10.2.4 Connection	152
7.5.1 Connection.....	115	10.2.5 Live View (Portrait View)	152
7.5.2 Display Mode	115	10.2.6 Live view (Landscape View).....	153
7.5.3 Health Check.....	116	10.2.7 PTZ control	154
7.5.4 PTZ Control.....	116	10.2.8 Alarm Out Control.....	154
7.5.5 System Log	117	10.2.9 Search	155
7.6 Search Mode.....	117	10.2.10 Snapshot Gallery.....	156
7.6.1 Date/Time Search	117	10.2.11 Setting	156
7.6.2 Event Search.....	118	10.2.12 Uninstallation	157
7.6.3 POS/ATM.....	119	11. KEYBOARD CONTROLLER (AVK-P2500)	159
7.7 Disconnection	120	11.1 Connection.....	159
7.8 Uninstall.....	121	11.1.1 Configuration Diagram	159
8. XCMS VIEWER	123		

11.1.2	USB Connection	159	13.3.1	Introduction	180
11.2	Keyboard Setup in DVR	159	13.3.2	Features	180
11.3	Keyboard Configuration	160	13.3.3	Technical Specification	181
11.4	Setup	162	13.3.4	Unpacking	181
11.4.1	DVR Control Mode	162	13.3.5	Service	181
11.4.2	Speed Dome Setup	162	13.3.6	System Dimension Diagram	181
11.4.3	Joystick Calibration	162	13.3.7	Connector Wiring	181
11.5	Operation	163	13.3.7.2	RS-485 Connection	182
11.5.1	DVR/SPD Mode Conversion	163	13.3.7.3	Power Supply Connection	182
11.5.2	DVR Control Mode	163	13.3.8	PTZ Control	182
11.5.2.1	Connection	163	13.3.9	Cable	182
11.5.2.2	Buttons	163	13.3.10	Display	182
11.5.2.3	PTZ Mode	164	13.4	HSC2410	183
11.5.3	SPD Control Mode (Speed Dome) ...	164	13.4.1	Introduction	183
11.5.3.1	Connection	164	13.4.2	Features	183
12. TEXT-IN (POS)		167	13.4.3	Technical Specification	183
12.1	Usage of Serial-In Function	167	13.4.4	Unpacking	183
12.2	Connection Method	167	13.4.5	Service	183
12.3	Connection Diagram	167	13.4.6	System Dimension Diagram	183
12.4	Relay	169	13.4.7	Connector Wiring	184
12.4.1	Relay Setup (Optional)	169	13.4.8	Cable	184
12.4.2	Schedule Setup (Mandatory)	170	13.4.9	Display	184
12.5	Setup (Mandatory)	170	13.5	HSR1110	184
12.5.1	Text Overlay	170	13.5.1	Introduction	184
12.5.2	Link Cam	171	13.5.2	Features	184
12.5.3	Device Setting	171	13.5.3	Technical Specification	185
12.5.4	Example	172	13.5.4	Unpacking	185
12.6	Search	173	13.5.5	Service	185
13. HD-SDI VIDEO SIGNAL ACCESSORIES. 177			13.5.6	System Dimension Diagram	185
13.1	HSC1100	177	13.5.7	Connector Wiring	185
13.1.1	Introduction	177	13.5.8	Cable	186
13.1.2	Features	177	13.5.9	Display	186
13.1.3	Technical Specification	177	13.6	HSR1440	186
13.1.4	Unpacking	177	13.6.1	Introduction	186
13.1.5	Service	177	13.6.2	Features	186
13.1.6	System Dimension Diagram	177	13.6.3	Technical Specification	186
13.1.7	System Connection Diagram	178	13.6.4	Unpacking	187
13.1.8	Cable	178	13.6.5	Service	187
13.1.9	Display	178	13.6.6	System Dimension Diagram	187
13.2	HSC1200	178	13.6.7	Connector Wiring	187
13.2.1	Introduction	178	13.6.8	Cable	187
13.2.2	Features	179	13.6.9	Display	188
13.2.3	Technical Specification	179	13.7	HQS1004	188
13.2.4	Unpacking	179	13.7.1	Introduction	188
13.2.5	Service	179	13.7.2	Features	188
13.2.6	System Dimension Diagram	179	13.7.3	Technical Specification	188
13.2.7	Connector Wiring	179	13.7.4	Unpacking	188
13.2.8	Cable	180	13.7.5	Service	188
13.2.9	Operation Key and Screen Display Information	180	13.7.6	System Dimension Diagram	189
13.3	HSC2110	180	13.7.7	Connector Wiring	189
			13.7.8	Cable	189
			13.7.9	Display	189
			13.8	HFO1100 & HFO1200	190
			13.8.1	Introduction	190

13.8.2Features 190
13.8.3Technical Specification 190
13.8.4Unpacking 190
13.8.5Service..... 190
13.8.6System Dimension Diagram..... 191

13.8.7Connector Wiring191
13.8.8Cable191
13.8.9Display192

1. Product Features

1.1 Unpacking

- This equipment is an electronic appliance, so it should be handled with special care.
- After unpacking, please check if all the following items are included.
 - DVR Main body
 - **S Type**: Power Supply Adapter (DC 12V, 3A) and Power Supply Cable
 - **A, B and E (4CH) Type**: Power Supply Adapter (DC 12V, 5A) and Power Supply Cable
 - **C, D, E (8, 16CH), F, G (4CH), H, I and J Type**: Power Supply Adapter (DC 12V, 6.67A) and Power Supply Cable
 - **G (8, 16CH) Type**: Power Supply Cable
 - Remote Control With 2 AAA batteries
 - Installation CD (CMS Pro Software & User's Manual)
 - Quick Guide

1.2 Service

- If there is any problem in the product, please refer servicing to a supplier or a distributor with qualified service personnel.

WARNING

WARRANTY IS VOID IF SEAL OR LABEL IS REMOVED OR DAMAGED.

1.3 System Connection Diagram

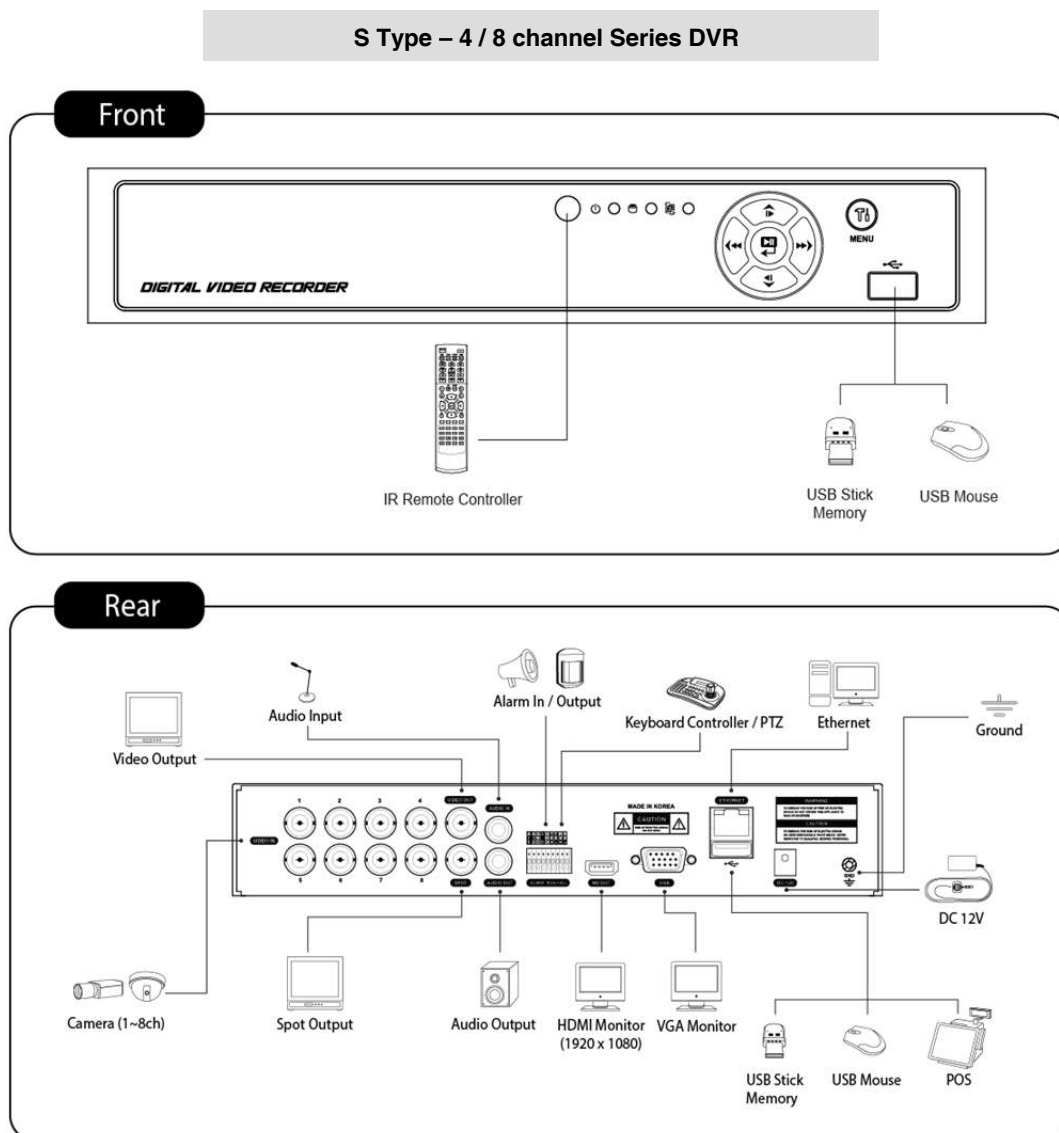

A Type – 4 / 8 / 16 channel Series DVR

Front

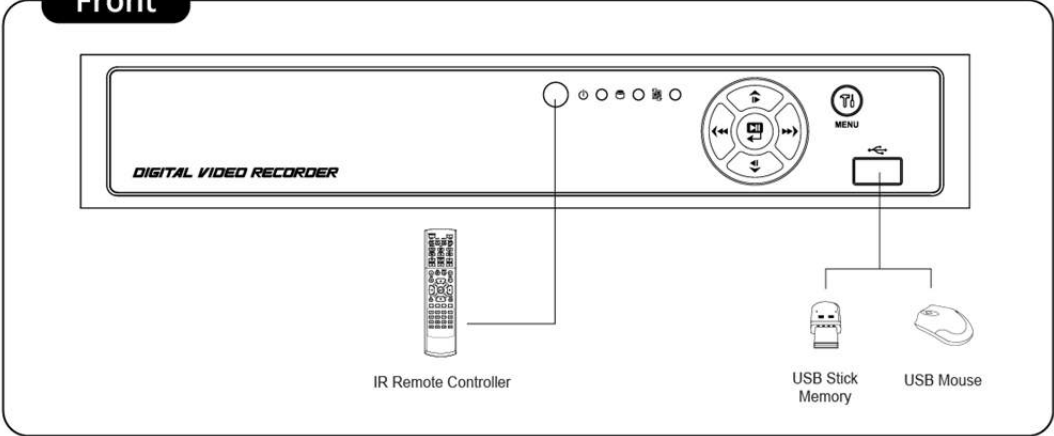

Rear

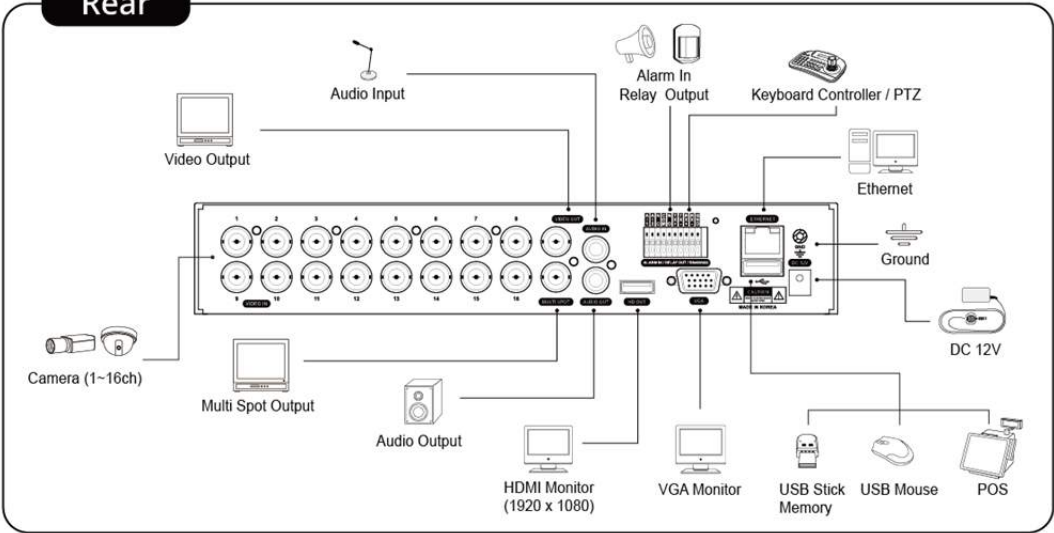

B Type – 4 / 8 / 16 channel Series DVR

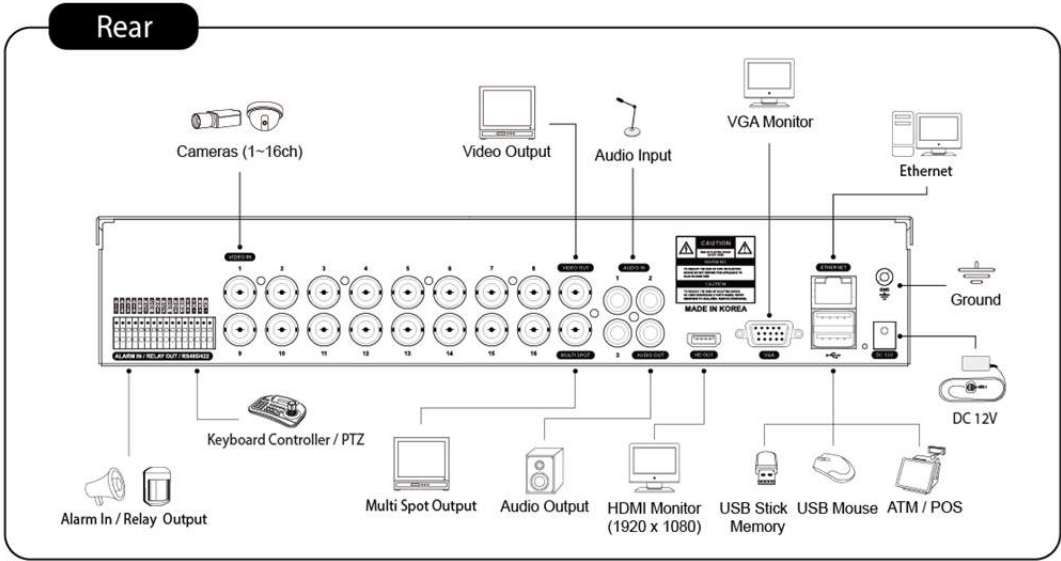
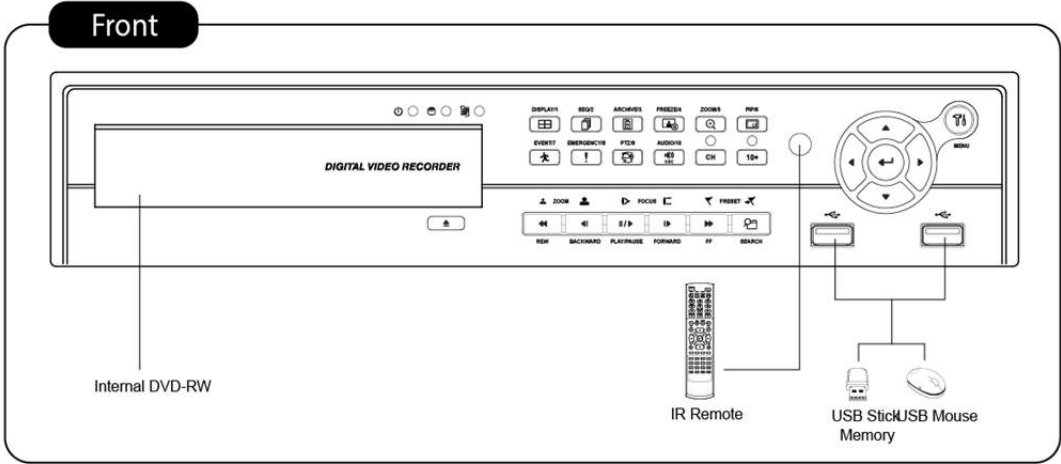

C Type – 4 / 8 / 16 channel Series DVR

Front

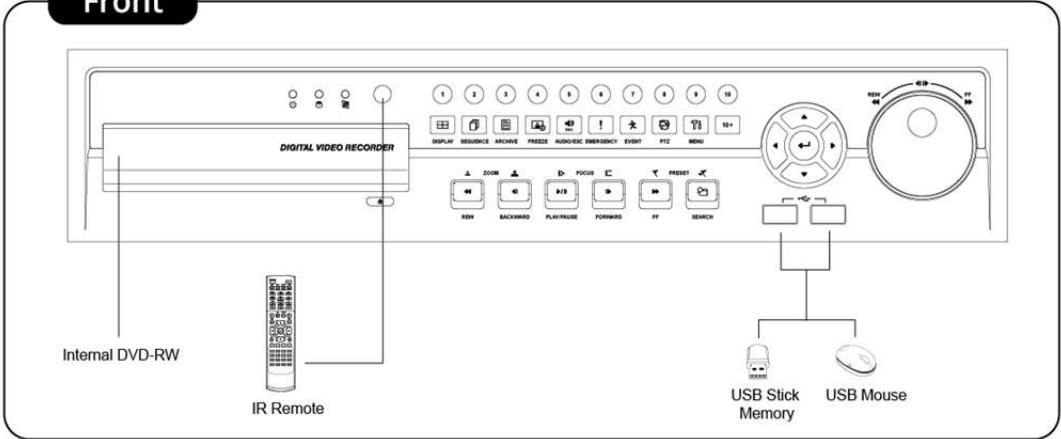

Rear

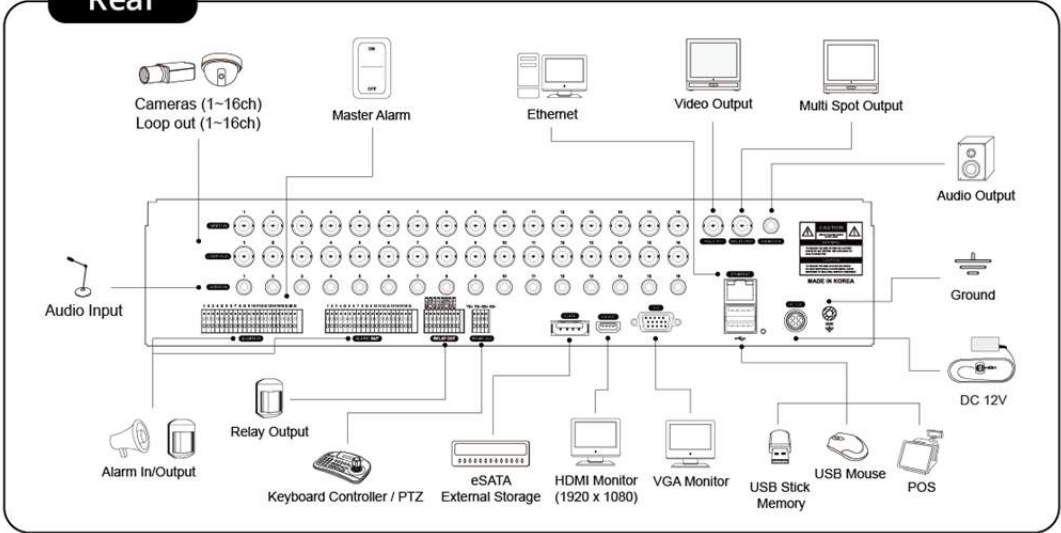

D Type – 4 / 8 / 16 channel Series DVR

Front

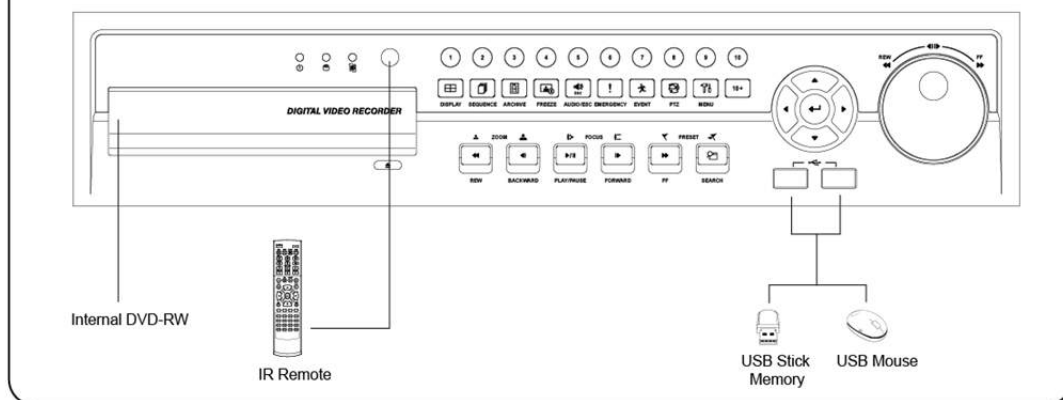

Rear

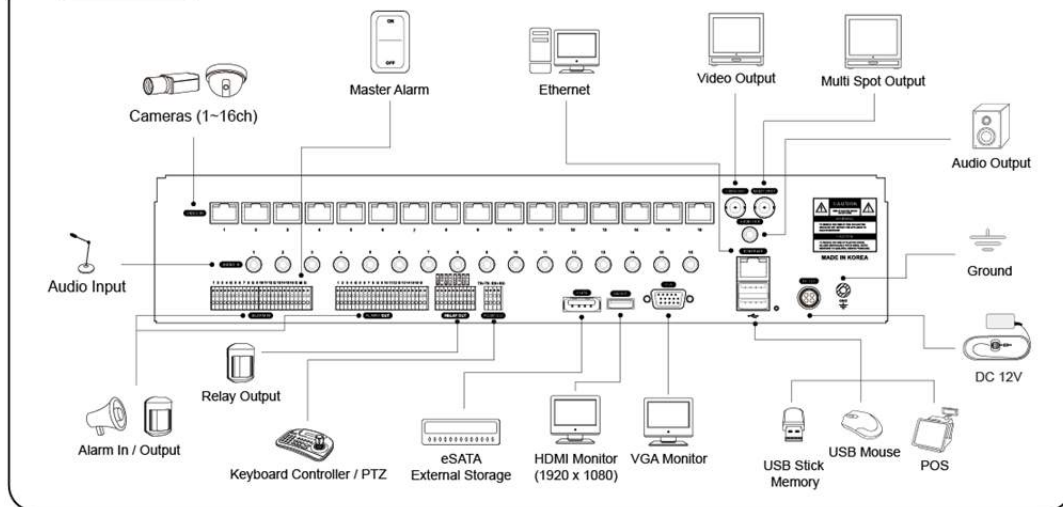

E Type – 4 channel Series HD-SDI DVR

Front

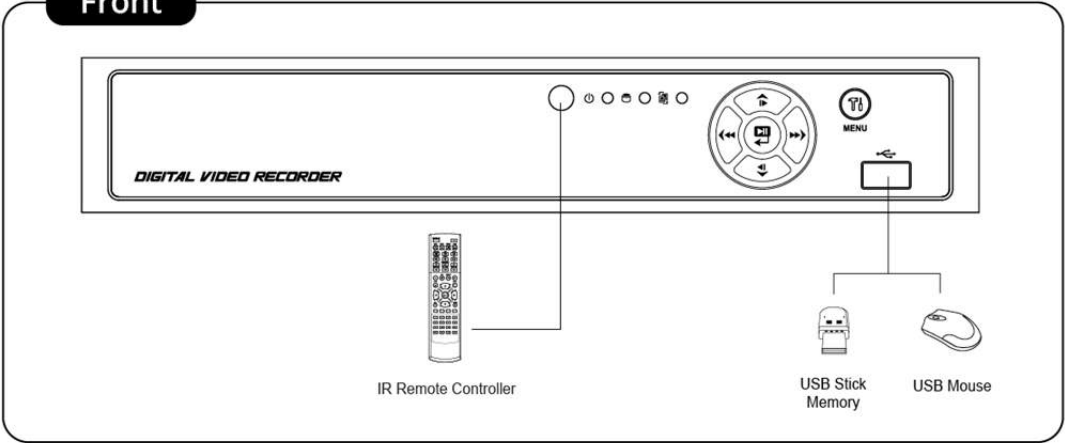

Rear

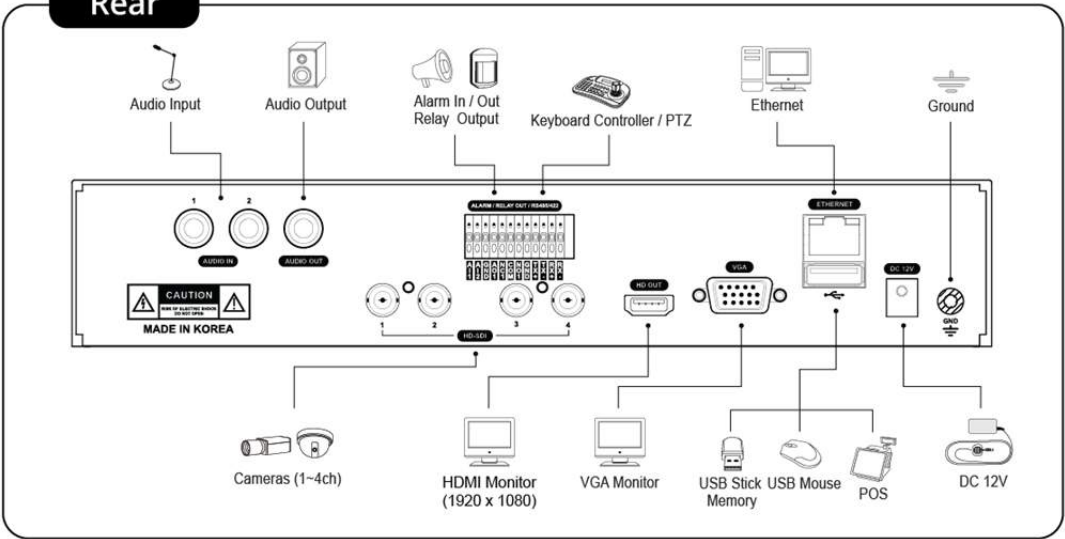

E Type – 8 / 16 channel Series HD-SDI DVR

Front

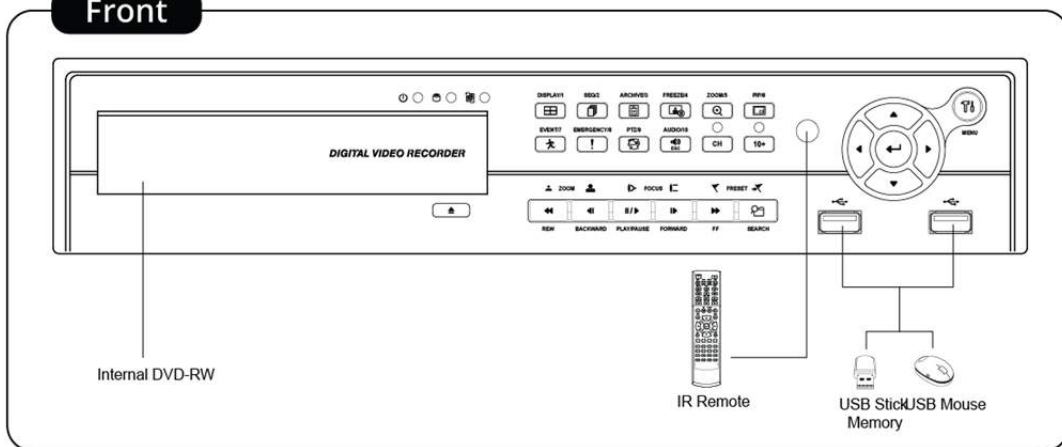

Rear

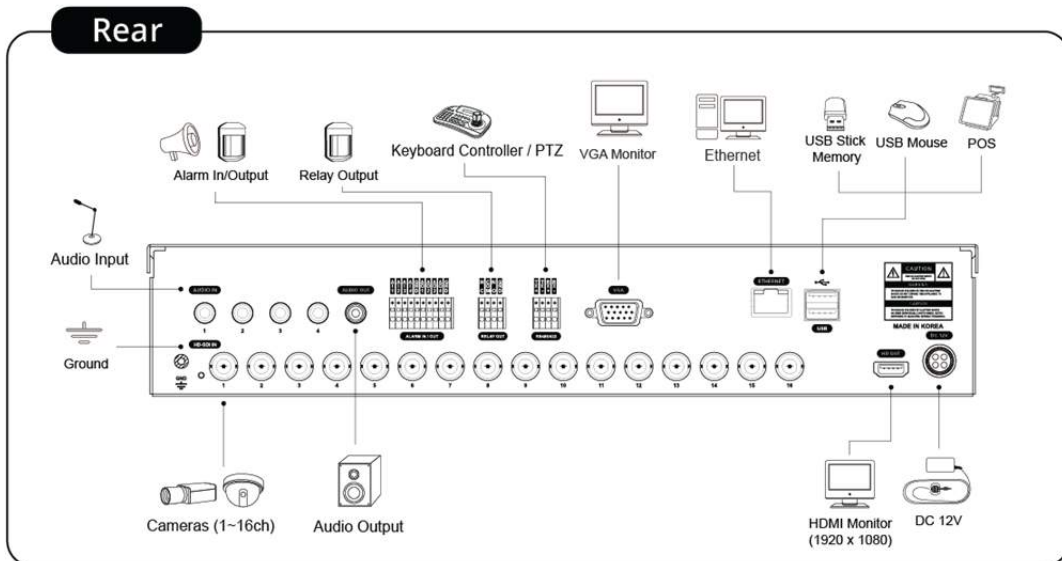

F Type – 4 / 8 / 16 channel Series HD-SDI DVR

Front

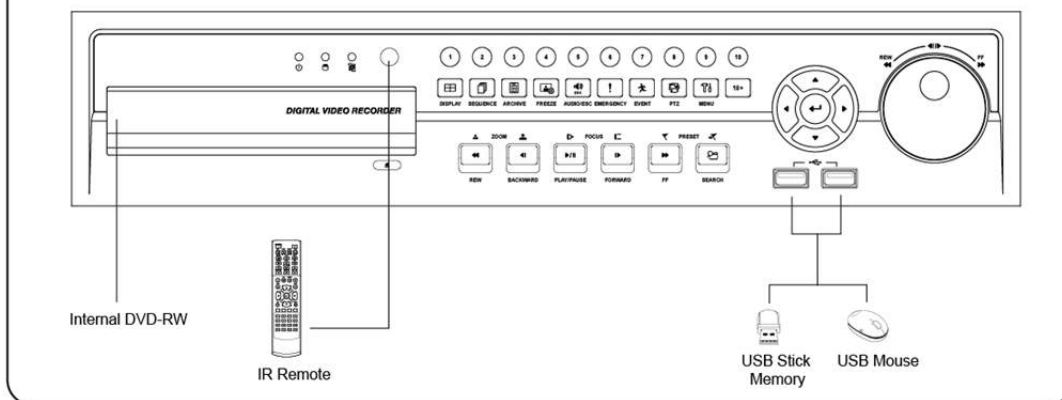

Rear

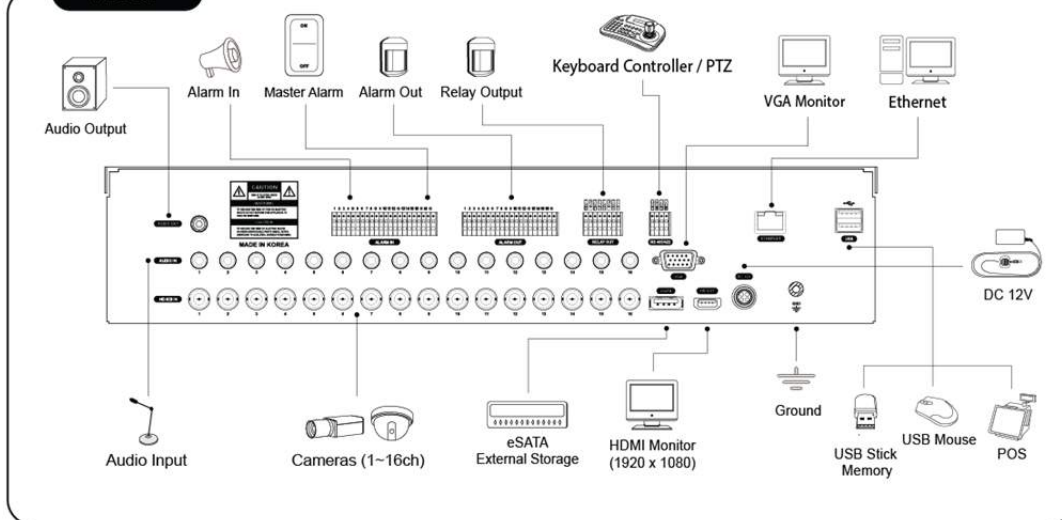

G Type – 4 channel Series HD-SDI DVR

Front

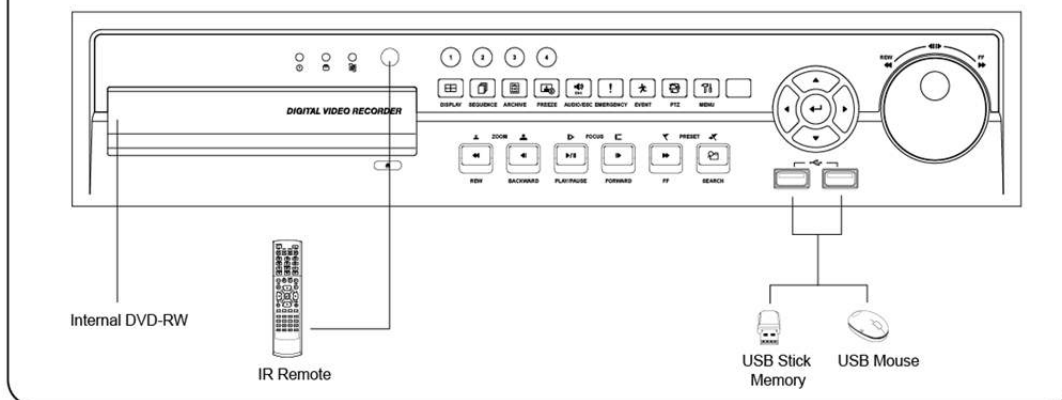

Rear

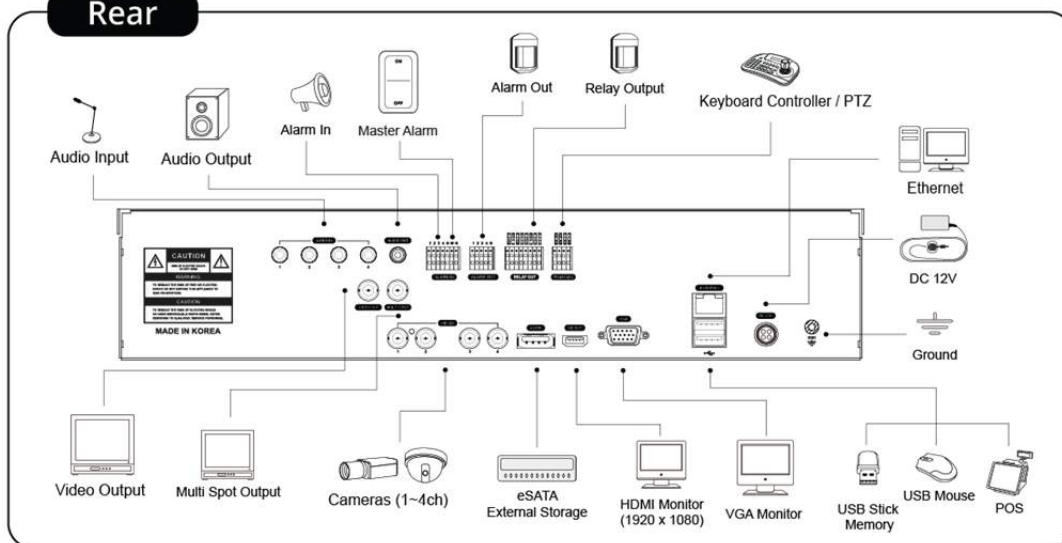

G Type – 8 / 16 channel Series HD-SDI DVR

Front

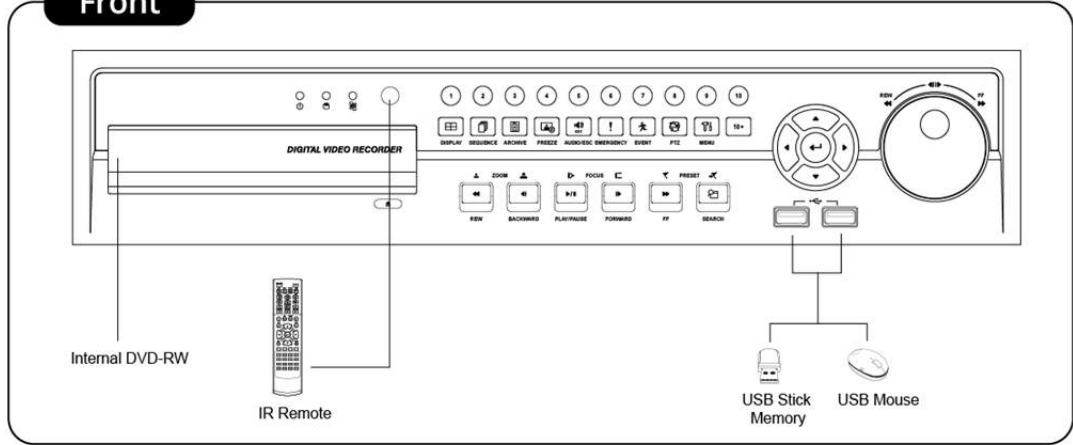

Rear

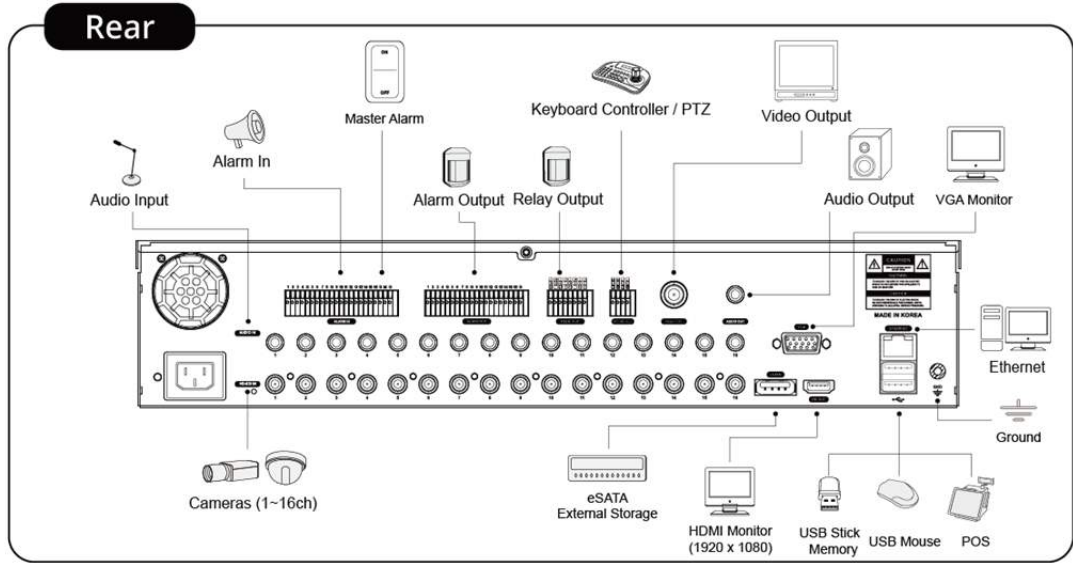

H Type – 4 channel Series HD-SDI DVR

Front

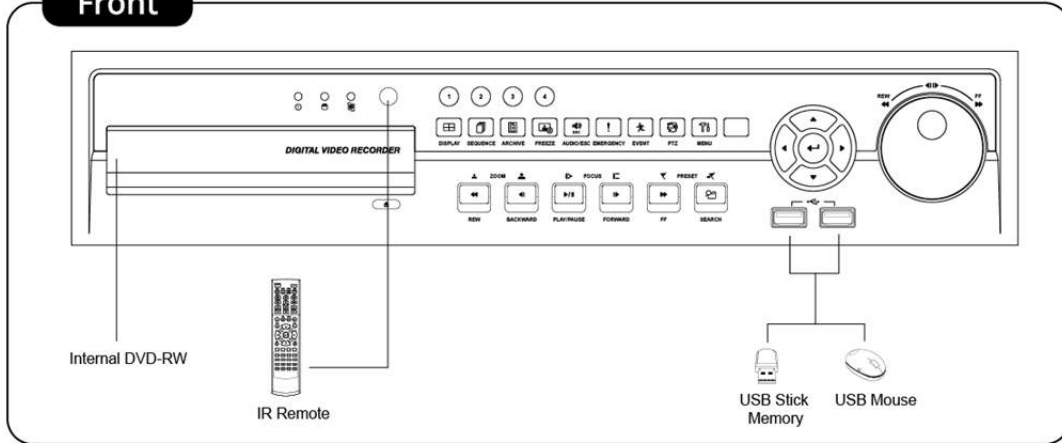

Rear

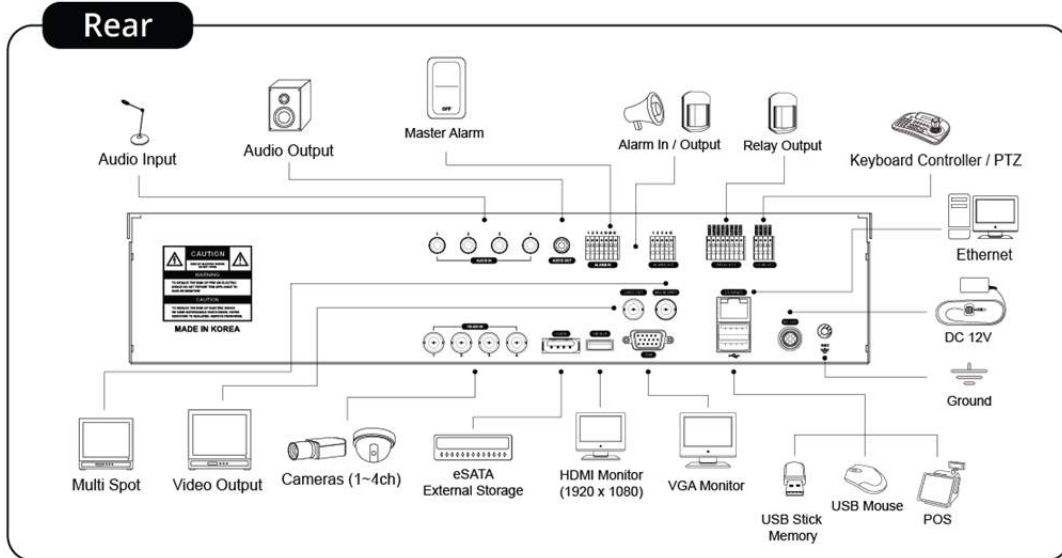

I Type – 4 + 4 / 4 + 12 channel Series Hybrid DVR

Front

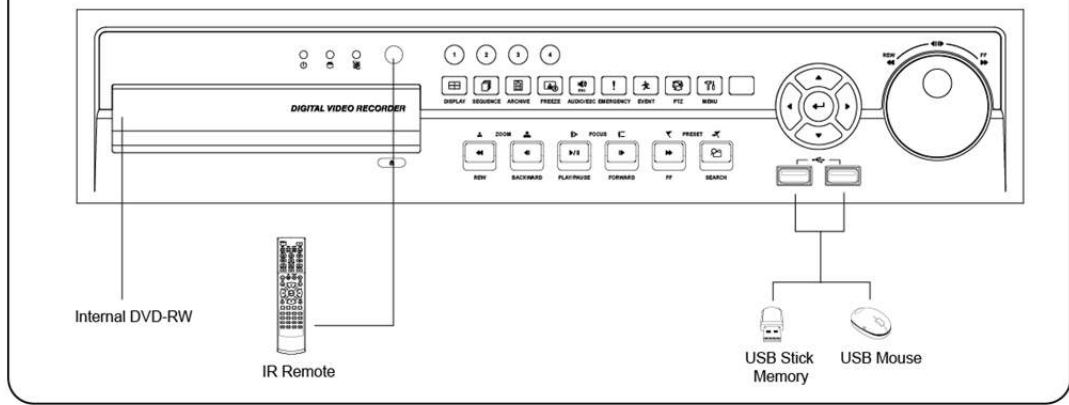

Rear

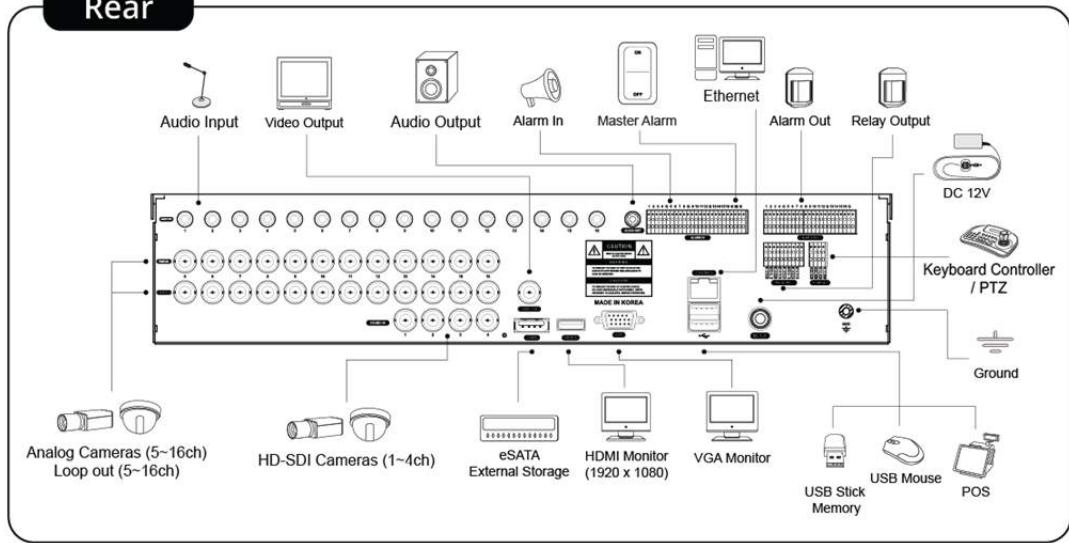

J Type – 8 / 16 channel Series True Hybrid DVR

Front

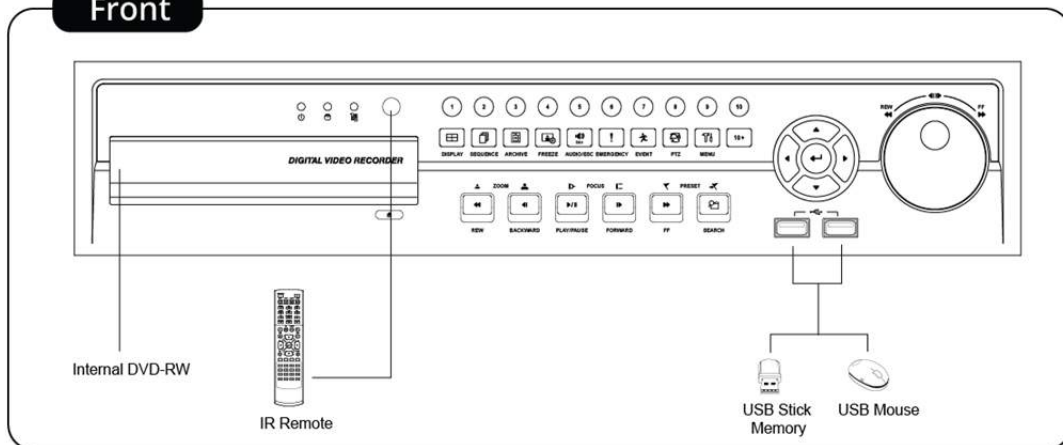

Rear

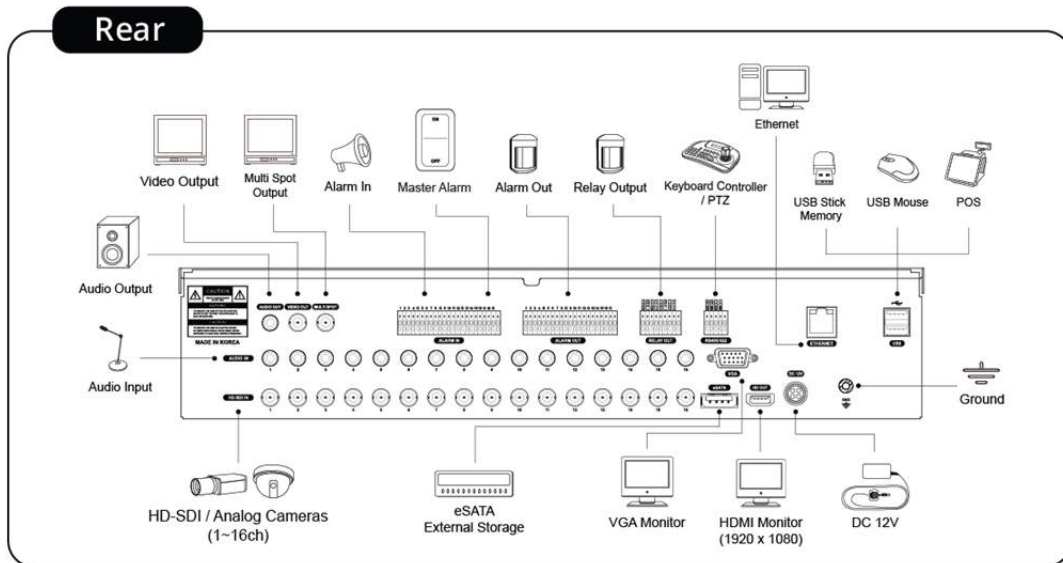

2. Installation

2.1 Hard disk and DVD-RW Installation

2.1.1 SATA Port

- When installing HDDs, make sure to connect from SATA 1 Port.
- **S and E (4CH) Type**
 - Main board of this DVR has one SATA port: it is indicated as SATA 1.
- **A Type**
 - Main board of this DVR has two SATA port: it is indicated as SATA 1 and 2.
- **B and E (8, 16CH) Type**
 - Main board of this DVR has three SATA port: it is indicated as SATA 1, 2 and 3.
 - Please mount DVD-RW at the **SATA 3 port**.
- **C, D, F, G, H, I and J Type**
 - Main board of this DVR has five SATA ports: they are indicated as SATA 1, 2, 3, 4 and SATA 5.
 - Please mount DVD-RW at the **SATA 5 port**.
- Up to five SATA devices (HDD and DVD-RW) are able to be connected to the SATA ports in serial; however the devices must be connected onto correct SATA port.
- Refer to the table below to mount HDDs and DVD-RW.

S and E (4CH) Type

4 / 8 CH DVR	Storage		SATA 1 Port	
	HDD			
	1		HDD	

A Type

4 / 8 / 16 CH DVR	Storage		SATA 1, 2 Port	
	HDD		1	2
	1		HDD	---
	2		HDD	HDD

B and E (8, 16CH) Type

4 / 8 / 16 CH DVR	Storage		SATA 1, 2, 3 Port		
	HDD	DVD-RW	1	2	3
	1	1	HDD	---	DVD-RW
	2	1	HDD	HDD	DVD-RW
	2	0	HDD	HDD	---

C, D, F, G, H, I and J (8, 16CH) Type

4 / 8 / 16 CH DVR	Storage		SATA 1, 2, 3, 4, 5 Port				
	HDD	DVD-RW	1	2	3	4	5
	1	1	HDD	---	---	---	DVD-RW
	2	1	HDD	HDD	---	---	DVD-RW
	3	1	HDD	HDD	HDD	---	DVD-RW
	4	1	HDD	HDD	HDD	HDD	DVD-RW
4	0	HDD	HDD	HDD	HDD	---	

2.1.2 Internal SATA Storage

- **C, D, F, G, H, I and J Type** DVR have 5 internal SATA Ports.
- 1-4 SATA Port: It is designed to mount HDD. Connect from SATA 1 port when installing HDDs.
- 5 SATA Port: Please mount a DVD-RW.
- Only one DVD-RW can be installed among the SATA Ports.

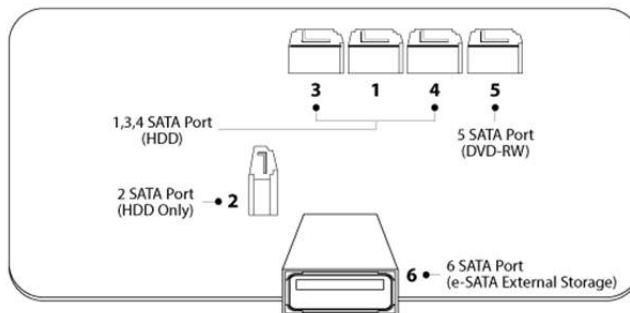

2.1.3 e-SATA External Storage (C, F, G, H, I and J Type)

- These series DVRs have one external SATA Port; the picture above shows external **SATA 6 Port**.
- 6 SATA Port: It is designed to mount up to 4HDDs per external SATA Port.

2.1.4 HDD Installation

- Securely mount a hard disk using bracket and screws provided.
- Please do not use any different hard disk cables (data cable and power supply cable) other than provided.
- Otherwise, it may cause damage to the hard disk.

CAUTION

INSTALL DVD-RW OR/AND HARD DISK AFTER DVR POWER OFF. OTHERWISE, IT MAY CAUSE PERMANENT DAMAGE TO THE HARD DISK. TO TURN OFF DVR, PLEASE USE SHUTDOWN KEY ON SYSTEM MUNU BAR LOCATED ON THE RIGHT MARGIN. AND THEN UNPLUG THE POWER CABLE FROM DVR.

2.1.5 HDD Capacity

- Each model has different HDD capacity.
- Below table shows the maximum HDD capacity for each model.

Type	S, E (4CH)	A~B	C~D	E (8, 16CH)	F~J
Capacity	3TB	6TB	12TB	6TB	12TB

2.1.6 DVD-RW Installation

- Securely mount DVD-RW using bracket and screws provided.
- Please do not use any different DVD-RW cables (data cable and power supply cable) other than provided.
- Otherwise, it may cause damage to the DVD-RW.
- Only one DVD-RW can be used. Mount it at the SATA 3 port (**B, and E (8, 16CH)**) and SATA 5 port (**C, D, F, G, H, I and J Type**).

CAUTION

INSTALL DVD-RW OR/AND HARD DISK AFTER DVR POWER OFF. OTHERWISE, IT MAY CAUSE PERMANENT DAMAGE TO THE HARD DISK. TO TURN OFF DVR, PLEASE USE SHUTDOWN KEY ON SYSTEM MUNU BAR LOCATED ON THE RIGHT MARGIN. AND THEN UNPLUG THE POWER CABLE FROM DVR. ALSO, WAIT FOR 5 SECONDS BEFORE PLUGGING IN POWER SUPPLY AGAIN.

2.2 Connector Wiring

2.2.1 Video-In/Loop Out Connections

S, A, B, C and D Type

- Connect Analog camera to 'VIDEO IN'.
- If a user wishes to link a camera input to another device, use 'LOOP OUT'. (**C and I Type**).
- Assure the 'VIDEO IN' (top connector) and 'LOOP OUT' (bottom one) connections are connected properly, not opposite way.

E, F, G and H Type

- Connect HD-SDI cameras to 'HD-SDI IN' from channel 1 to 16.

I Type

- Connect HD-SDI cameras to 'HD-SDI IN' from channel 1 to 4.
- Connect Analog cameras to 'VIDEO IN' from channel 5 to 16.

J Type (True Hybrid)

- Connect HD-SDI or Analog cameras to 'any' from channel 1 to 16.

NOTE

Only **C and I Type** model supports LOOP OUT connection.

NOTE

Please reboot the DVR, when switch from HD-SDI to Analog or Analog to HD-SDI (**J type only**)

2.2.2 HD-SDI Input Signal detection (E, F, G, H, I and J Type)

- These types of DVRs automatically detect the video signals of 720P 24, 720P 25, 720P 30, 720P 50, 720P 60, 1080i 50, 1080i 60, 1080P 24, 1080P 25, 1080P 30, 1080P 50, 1080P 60 (Auto Detection) when the system starts.
- 720P and 1080P HD-SDI inputs can be used simultaneously with no restriction.

NOTE

1080i input cannot be used simultaneously with 720P and/or 1080P and does not support digital zoom in live mode.
(**E (8, 16CH) and F (8, 16CH) Type**)

2.2.3 Monitor Connections (Video Out, VGA and Multi Spot)

- Video Out (**S, A, B, C, D, G, H, I and J Type Only**)
 - Use with the CCTV monitor.
 - Connect BNC cable between CCTV monitor and 'VIDEO OUT' of the DVR.
- VGA
 - Use with the computer monitor.
 - Connect VGA cable between computer monitor and 'VGA' of the DVR
- Spot (**S Type Only**)
 - This function supports one Channel Display on Spot Monitor
 - Connect BNC cable between spot monitor and spot port of rear panel.
- Multi Spot (**A, B, C, D, G (4 CH) and J Type Only**)
 - This function supports Multi-Channel Display on Spot Monitor
 - Connect BNC cable between spot monitor and multi spot port of rear panel.

CAUTION

BLACK SCREEN WILL DISPLAY IF THE MONITOR DOES NOT SUPPORT THE SELECTED RESOLUTION. IN ORDER TO CHANGE THE RESOLUTION PLEASE PRESS "REW>FF>BACKWARD>FORWARD" IN SERIES USING FRONT BUTTON OR REMOTE CONTROLLER THEN THE RESOLUTION WILL BE CHANGED TO '1024 X 768'.

2.2.4 HDMI connections

- Connect HDMI cable to HD out port of rear panel and HDMI port of HD output device.
- Please Click (←) **SETUP> DEVICE > DISPLAY > General** and the following screen will display.

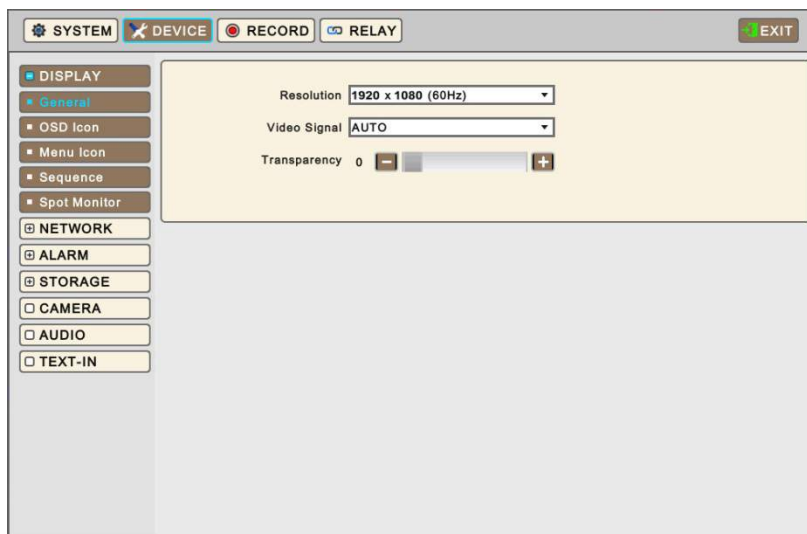

- Click the box below to select resolution.
 - A user can select the resolution among ‘1920x1080 (60Hz)’, ‘1920x1080 (50Hz)’, ‘1280x720 (60Hz)’, ‘1280x720 (50Hz)’ and ‘1024x768’.
 - If the resolution is changed then the DVR may restart automatically.
 - The default setting of DVR is ‘1920 x 1080 (60Hz)’.
- Click Video Signal box to select signal format.
 - A user can select the signal output among ‘NTSC’, ‘PAL’ and ‘AUTO’.
 - The default setting of DVR is ‘AUTO’

CAUTION

HDMI CONNECTION MAY NOT BE COMPATIBLE WITH CERTAIN OUTPUT DEVICE.
VIDEO NOISE MAY OCCUR DEPENDING ON THE TYPE OF HDMI CABLE USED. MAKE SURE TO USE AN HDMI-CERTIFIED CABLE.

CAUTION

BLACK SCREEN WILL DISPLAY IF THE MONITOR DOES NOT SUPPORT THE SELECTED RESOLUTION. IN ORDER TO CHANGE THE RESOLUTION PLEASE PRESS “**REW>FF>BACKWARD>FORWARD**” IN SERIES USING FRONT BUTTON OR REMOTE CONTROLLER THEN THE RESOLUTION WILL BE CHANGED TO ‘1024 X 768’.

2.2.5 Audio Connections

- Connect an audio device to ‘**AUDIO IN**’ and a speaker system to ‘**AUDIO OUT**’. Please use a speaker system with volume adjustable.

2.2.6 TCP/IP (Ethernet) Connections

- Connect to ‘**ETHERNET**’ connector with the LAN cable.
- When connect to Internet, use an ordinary LAN cable (Non-cross cable). However, when connect directly to a PC, please use only ‘Crossover cable’.

2.2.7 Alarm Connections (TTL)

- Connect Alarm Input (Sensor) to ‘AI 1~AI 4 (or AI 16)’ connectors and connect Sensor Common to ‘G’ connector.
- Connect Alarm Output (buzzer, siren, etc.) to ‘AO 1~AO 4 (or AO 16)’ connectors and connect Common to ‘G’ connector. (Except **A and B** type)

2.2.8 Master Alarm (C, D, F, G, H, I and J Type)

- Alarm In sensor will be deactivated if Master Alarm is on.
- Connect Master Alarm In to 'M' connectors.

2.2.9 Alarm Connections [Relay (Dry Contact)] (Except S Type)

- Connect Alarm Output (buzzer, siren, etc.) to 'NO and/or NC' connectors, Power to 'COM' connector and Ground to 'GND' connector.

2.2.10 RS-485/422 Connections

- PTZ Camera and Keyboard controller connector.
- Please use TX+, TX-, RX+ and RX- terminals accordingly.

2.2.11 RS-485 Over Coax Connection (S, A, B, C, I and J Type)

- PTZ Camera Connector
- Please connect Coax to 'Video In' and select any Protocol in Camera/PTZ setup.

NOTE

PTZ Camera must support RS-485 over Coax function in order to use this feature.

NOTE

When selecting Protocol, a user can choose any protocol from the Protocol list other than 'NONE'. If 'NONE' is selected then RS-485 over Coax will not work.

2.2.12 USB Connections

- There are up to four identical USB ports in front and in rear. It is possible to connect a USB memory stick to archive data or a mouse to control the device.

2.2.13 Grounding (Earthing)

- Connection of ground wire is highly recommended to protect the DVR from external electric shock, such as lightning, electrical surge.

2.2.14 Factory Reset Switch

- Reset the switch to restore all setup values to factory default. It also deletes System Log File.
- The switch is located in a pin hole of the back panel.
- Using a paper clip, press and hold the reset switch for 2-3 seconds and release until popup message will display.

2.2.15 Power Supply connections

- **S Type:** Plug the power supply adapter (**DC 12V, 3A, included**) to 'DC12V' connector and plug another side to power source. Adapter input voltage is a free volt (100 VAC ~ 240 VAC). Please do not use any different power supply adapter because it may cause the DVR to malfunction.
- **A, B and E (4CH) Type:** Plug the power supply adapter (**DC 12V, 5A, included**) to 'DC12V' connector and plug another side to power source. Adapter input voltage is a free volt (100 VAC ~ 240 VAC). Please do not use any different power supply adapter because it may cause the DVR to malfunction.
- **C, D, E (8, 16CH), F, G (4CH) H, I and J Type:** Plug the power supply adapter (**DC 12V, 6.67A, included**) to 'DC12V' connector and plug another side to power source. Adapter input voltage is a free volt (100 VAC ~ 240 VAC). Please do not use any different power supply adapter because it may cause the DVR to malfunction.
- **G (8 / 16CH) Type:** Plug the power source. Products input voltage is a free volt (100 VAC ~ 240 VAC).
- Please do not use any different power supply adapter because it may cause the DVR to malfunction.























2.2.16 Connections Guideline

- **Video out Connector:** If only the monitor is connected to VIDEO OUT connector, please set the impedance switch on the rear side of the monitor to 75 ohms to prevent abnormally bright or collapsed images. If wish to connect another device (e.g., a recorder) to the back of the monitor, please set the impedance switch on the rear side of the monitor to HIGH Z (High Impedance) and set the last device to 75 ohms.
- **Alarm Input Connector:** Do not input any type of voltage to the AI 1~AI4 (AI 16) connectors.















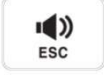

3. Input Device and Screen Icons

3.1 Key and LEDs

B and E (8, 16CH) Type

KEYS	PTZ KEY	Operating mode	Setup mode
▲, ▼, ◀, ▶		• Control Pan/Tilt rotation of up/down/left/right in PTZ mode	• Up/Down/Left/Right on screen cursor control
MENU		• Enter the Main Menu (Setup mode)	
DISPLAY		• Select 1/4/8/9/10/16 channel display.	
SEQUENCE		• Channel sequence mode on/off (Main Monitor)	
ARCHIVE		• Copy video data into the external storage device	
FREEZE		• Screen freeze mode on/off	
Zoom		N/A	
PIP		• Picture In Picture display on	
EVENT		• System Log display on	
EMERGENCY		• Emergency recording on	
PTZ		• Pan/Tilt/Zoom control mode on/off	
AUDIO/ESC		• Audio on/off on selected channel (Live View). • ESC (Menu)	
1 ~ 10		• Camera select keys : (4/8 channel DVR)	
11 ~ 16		• Camera select keys : (16 channel DVR)	
REW		• Fast backward playback (changes up to x128 with each press) • Zoom-Out on PTZ mode	
BACKWARD		• Frame backward playback • Zoom-In on PTZ mode	
PLAY/PAUSE		• Viewing mode: Instant playback (playback the recorded video from the last three minutes) • Playback mode: 1X PLAY/PAUSE • Focus Near in PTZ mode	
FORWARD		• Frame forward playback • Focus Far in PTZ mode	
FF		• Fast forward playback (changes up to x128 with each press) • Save Preset in PTZ mode	
SEARCH		• Video search mode on • Go to Preset in PTZ mode	
Power LED (Red)		• Light off: DVR off • Light on: DVR on	
HDD LED (Green)		• Light off: Standby Reading/Writing • Blink : DATA Reading/Writing	
Network LED (Yellow)		• Light off: No Devices are connecting to DVR through network (No User access) • Light On: Devices are Connecting to DVR through network (User access)	

C, D, F, G, H, I and J Type

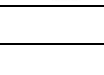
KEYS	PTZ KEY	Operating mode	Setup mode
▲, ▼, ◀, ▶		• Control Pan/Tilt rotation of up/down/left/right in PTZ mode	• Up/Down/Left/Right on screen cursor control
1 ~ 10 / 10+		• Camera select keys : (4/8/16 channel DVR)	
DISPLAY		• Select 1/4/8/9/10/16 channel display.	
SEQUENCE		• Channel sequence mode on/off (Main Monitor)	
ARCHIVE		• Copy video data into the external storage device	
FREEZE		• Screen freeze mode on/off	
AUDIO/ESC		• Audio on/off on selected channel (Live View). • ESC (Menu)	• EXIT
EMERGENCY		• Emergency recording on	
EVENT		• System Log display on	
PTZ		• Pan/Tilt/Zoom control mode on/off	
MENU		• Enter the Main Menu (Setup mode)	
REW		• Fast backward playback (changes up to x128 with each press) • Zoom-Out on PTZ mode	
BACKWARD		• Frame backward playback • Zoom-In on PTZ mode	
PLAY/PAUSE		• Viewing mode: Instant playback (playback the recorded video from the last three minutes) • Playback mode: 1X PLAY/PAUSE • Focus Near in PTZ mode	
FORWARD		• Frame forward playback • Focus Far in PTZ mode	
FF		• Fast forward playback (changes up to x128 with each press) • Save Preset in PTZ mode	
SEARCH		• Video search mode on • Go to Preset in PTZ mode	
Power LED (Red)		• Light off: DVR off • Light on: DVR on	
HDD LED (Green)		• Light off: Standby Reading/Writing • Blink : DATA Reading/Writing	
Network LED (Yellow)		• Light off: No Devices are connecting to DVR through network (No User access) • Light On: Devices are Connecting to DVR through network (User access)	

NOTE

S, A and E (4CH) Type has a Menu key and direction keys in the front.

3.2 Camera Select Keys for 16 Channel DVR

B and E (8, 16CH) Type



- Below shows how to select camera channel for 4 channel DVR
 - Select Camera No. 1~4: press **CH** key and use **1~4** key
- Below shows how to select camera channel for 8channel DVR
 - Select Camera No. 1~8 press **CH** key and use **1~8**key
- Below shows how to select camera channel for 16channel DVR
 - Select Camera No. 10~16: press **CH** key and use **10+**, **1~6** key

C, D, F, G, H, I and J (8, 16CH) Type

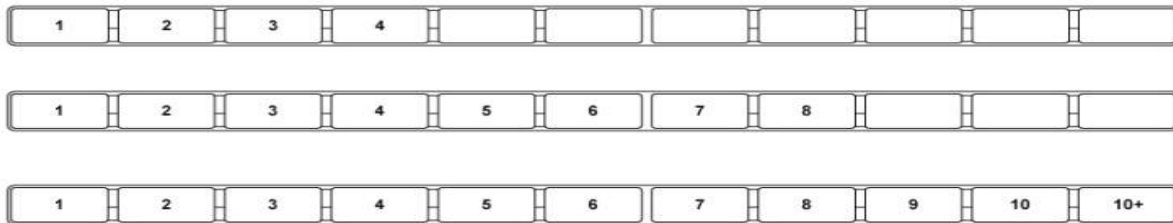

- Below shows how to select camera channel for 16 channel DVR
 - Select Camera No. 1~10: use **1~10** direction key
 - Select Camera No. 11~16: press **10+** key and use **1~6** direction key

3.3 Front Panel

S (4, 8CH), A, E (4CH) Type

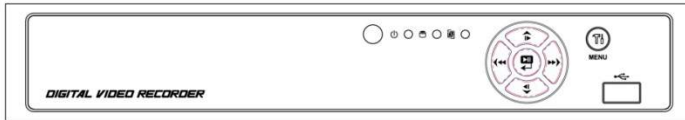

4 / 8 / 16 Channel DVR

B and E (8, 16CH) Type

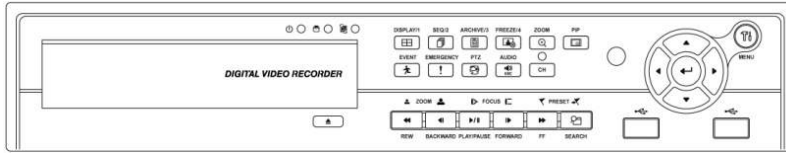

4 Channel DVR

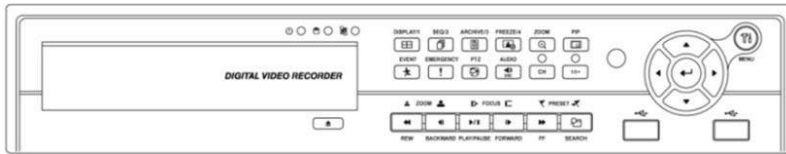

8 Channel DVR

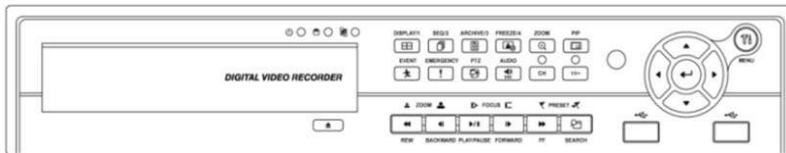

16 Channel DVR

C, D, F, G, H, I and J (8, 16CH) Type

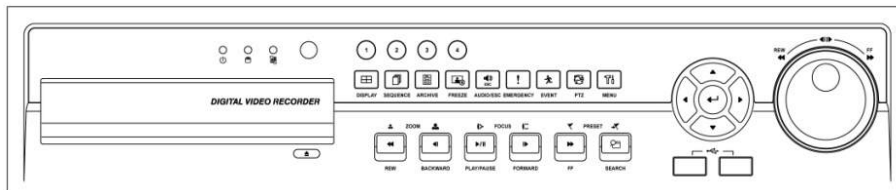

4 Channel DVR

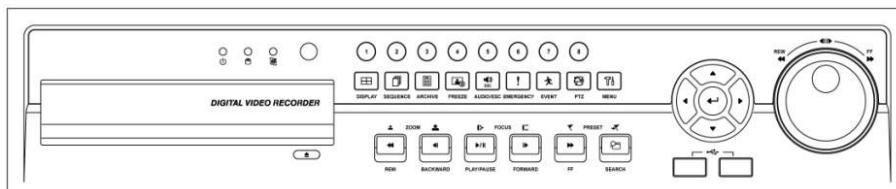

8 Channel DVR

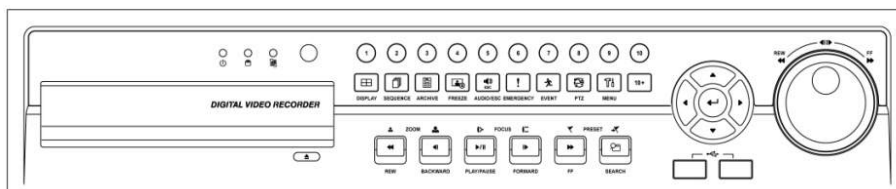

16 Channel DVR

3.4 Using a Remote Controller

- Usage of a remote controller is same as the front panel keys.
- Follow the procedure below when you use one remote controller for multi DVRs.
 - ① Check System ID (e.g., between 1 and 255) of the DVR that wish to use.
 - (SETUP>SYSTEM>Status>General or Status window).
 - ② ID Setup: Holding up the remote controller to face towards the DVR and press the System ID numbers one by one, while pressing ID button on the remote controller. The System ID is a **3-digit number**. Button '10' functions the same as '0'.
 - (e.g.: If System ID is 3, press 10>10>3 buttons in sequence while pressing the ID button)

3.5 Using a Mouse

- Mouse provides an easier access to adjustment. Refer to below for proper use.
- Left mouse button functions the same as **Enter** (↵) key on the front panel of DVR.
- Right mouse button displays the channel function key such as Audio, PTZ, PIP, Color and Position on selected channel.

S, A, B, C and D Type

Name of Key	Function
Audio	Enable/Disable Audio
Color	Change Brightness / Contrast / Saturation of the selected channel. (When supported)
PTZ	Enable/Disable PTZ control
PIP	Picture in Picture function
Position	Change the position of the each channel.

E (4CH), F (4CH), G, H and I Type

Name of Key	Function
Audio	Enable/Disable Audio
PTZ	Enable/Disable PTZ control
PIP	Picture in Picture function



























E (8, 16CH) and F (8, 16CH) Type

Name of Key	Function
Audio	Enable/Disable Audio
PTZ	Enable/Disable PTZ control

J Type

Name of Key	Function
Audio	Enable/Disable Audio
Color	Change Brightness / Contrast / Saturation of the selected channel. (When supported)
PTZ	Enable/Disable PTZ control
Position (Analog Input)	Change the position of the each channel.

3.6 Screen Icon

Icon	Description	Icon	Description
	Continuous recording schedule		Continuous + Motion recording schedule
	Motion recording schedule		Motion + Alarm recording schedule
	Alarm recording schedule		Cont. + Motion + Alarm recording schedule
	Continuous + Alarm recording schedule		No Record
	Continuous recording mode		Motion recording mode
	Alarm recording mode		Emergency recording mode
	Audio recording (When connected)		PTZ registration
	Recording in progress		Remote access indication/ No. of connected users (up to 16)
	In channel sequencing		Audio channel
	Master Alarm Overwritten		Date / Time
	HDD Overwriting Enabled		HDD Overwriting Disabled (Recording)
	Estimated HDD usage		Keyboard controller mode
	PTZ mode		Spot out Enabled
	Key Locked		

4. Setup

4.1 Login

• For security purpose, a user has to input the password to enter the setup menu.

• Please press  from Display Menu Bar to enter the setup menu and the following screen will display.



The login dialog box has a title bar with a green checkmark and the word "Login". It contains a "User ID" dropdown menu with "admin" selected, a "Password" text input field with a password icon, and "OK" and "Cancel" buttons at the bottom.

- In order to use all functions and privileges, log in as ID: admin.
- Default Password is "1111".
- After login successfully, following screen will display.

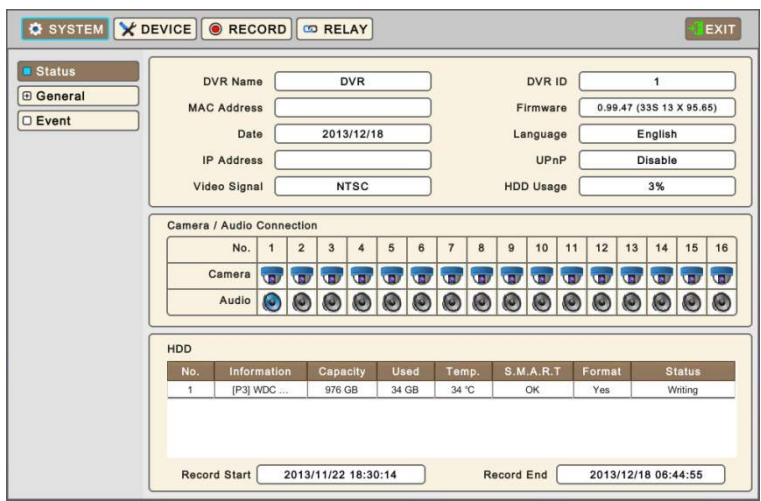

The main setup menu has a top navigation bar with "SYSTEM", "DEVICE", "RECORD", and "RELAY" tabs, and an "EXIT" button. A left sidebar shows "Status", "General", and "Event" options. The main area displays various settings:

- DVR Name: DVR, DVR ID: 1
- MAC Address: [empty], Firmware: 0.99.47 (33S 13 X 95.65)
- Date: 2013/12/18, Language: English
- IP Address: [empty], UPnP: Disable
- Video Signal: NTSC, HDD Usage: 3%

Below is a "Camera / Audio Connection" table with 16 columns (No. 1-16) and rows for Camera and Audio.

No.	1	2	3	4	5	6	7	8	9	10	11	12	13	14	15	16
Camera	[icon]	[icon]	[icon]	[icon]	[icon]	[icon]	[icon]	[icon]	[icon]	[icon]	[icon]	[icon]	[icon]	[icon]	[icon]	[icon]
Audio	[icon]	[icon]	[icon]	[icon]	[icon]	[icon]	[icon]	[icon]	[icon]	[icon]	[icon]	[icon]	[icon]	[icon]	[icon]	[icon]

Below is an "HDD" table:

No.	Information	Capacity	Used	Temp.	S.M.A.R.T	Format	Status
1	[P3] WDC ...	976 GB	34 GB	34 °C	OK	Yes	Writing

At the bottom, there are "Record Start" (2013/11/22 18:30:14) and "Record End" (2013/12/18 06:44:55) fields.

- Main menu consists of 4 sub menu.
 - **SYSTEM / DEVICES / RECORD / RELAY**
- To escape from the setup menu and save settings of DVRs, please Click Exit button on the screen.
- A user may use ◀, ▶ direction keys or mouse Click to exit from Setup. Please Click (↵) the EXIT button on the screen.

NOTE
Press AUDIO/ESC in the setup screen. It operates like CANCEL (ESC). During live mode, AUDIO/ESC button operates as on/off of audio (focused channel) and playback mode, it operates like EXIT from playback mode or CLOSE (if any popup existing.)

NOTE
Recording does NOT stop by menu accesses.

4.2 SYSTEM

4.2.1 Status

- Entering Setup Menu following screen will display.

No.	Information	Capacity	Used	Temp.	S.M.A.R.T	Format	Status
1	[P3] WDC ...	976 GB	34 GB	34 °C	OK	Yes	Writing

- System Status show information of the DVR like followings

- DVR name
- DVR ID
- MAC Address
- Firmware
- Date
- Language
- IP Address
- UPnP
- Video Signal
- HDD Usage
- Camera / Audio Connection
- HDD information
- Record Start & End time

NOTE

Values cannot be changed at 'Status'. Please see 'General' to change the value.

4.2.2 General



- Please Click (←) **SYSTEM>General** and the following screen will display.

Setup

DVR Name

- Name your DVR on your own.
- Please Click (↔) keyboard icon on DVR Name box and the following virtual keyboard will display.





- Please Click (↔) desired letters (characters) on the virtual keyboard to input.
 - ①  Use to erase one character every time.
 - ②  Use to erase the whole line.
 - ③  Use to move the cursor (Also you can use a mouse to move the cursor between characters)
- Please choose 'OK' to confirm the input and choose 'Cancel' to cancel.

DVR ID

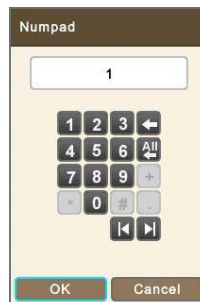
- Assign a unique ID for each DVR when you have multiple DVRs in a location.
- The unique ID is necessary with Remote Controller and/or Joystick operations.
- Please Click (↔)  on DVR ID box and the following virtual Numpad will display



- Take any whole number **between 1 and 255**.
- Please Click (↔) desired numbers on the virtual Numpad to input.
 - ①  Use to erase one number every time.
 - ②  Use to erase the whole numbers.
 - ③  Use to move the cursor (Also you can use a mouse to move the cursor between numbers)
- Please choose 'OK' to confirm the input and choose 'Cancel' to cancel.

Date Format

- Set date display format. Please Click (↔) Drop-down list of Date Format to select a format.

Time Format

- Set time display format. Please Click (↔) Drop-down list of Time Format to select a format.

Language

- Set menu display Language. Please Click (↔) Drop-down list of Language to select a language.

Setup

- **Import:** Copy a DVR configuration file stored in USB memory stick to DVR. Please plug in the memory stick and then Click (↔)

Import

– Please choose 'OK' to confirm and choose 'Cancel' to cancel.

- **Export:** Store the Menu setup of DVR to USB memory stick. Please plug in the memory stick and then Click (↔)

Export

- **Default:** Click (↔) **Default** to restore all setup values to default settings

– Please choose 'OK' to confirm and choose 'Cancel' to cancel.

NOTE

Import or Default process may restart the DVR.

Date / Time

- Adjust the current Date and Time of the DVR.
- Click Date/Time Button on the right hand side and following virtual calendar will display.



- Please follow the procedure below for date adjustment.
 - ① Use arrow buttons in the Month Calendar to select Year, Month and Day.
 - ▶▶: Move to next 'Year'
 - ◀◀: Move to previous 'Year'
 - ▶: Move to next 'Month'
 - ◀: Move to previous 'Month'
 - ② Click (↔) a date. The date will be displayed in blue color.
- Please follow the procedure below for time adjustment.
 - ① Click (↔) items (AM/PM, H, M, S) to change. A selected item will be highlighted in a box
 - ② Adjust the number by Clicking (↔) ▲, ▼ buttons on the right-hand side.
 - ③ Repeat the same procedure to change AM/PM, H, M and S.
- Please choose 'OK' to confirm the adjusted date and time, choose 'Cancel' to cancel.

CAUTION

IF ADJUSTED DATE/TIME IS PRIOR TO RECORDED DATA, DATA AFTER NEW DATE/TIME MAY BE ERASED.

NOTE

It is strongly recommended to do 'Clear All Data' (SETUP>DEVICE>Storage>HDD Format)

NTP Server

- Adjust the NTP (Network Time Protocol, automatic time sync.) Server address and Check Interval when NTP is being used.
- Click (↔) **NTP Setup** on the right hand side and following window will display.



- Please Click (↔) Select box next to Check NTP Server in Interval to sync the time regularly by selected interval.
- **NTP Server:** Click (↔)  or address in NTP Server box and the virtual keyboard will display. Input IP address of NTP server
- **Check Interval:** Set clock-update-interval from NTP Server. A user can adjust time every 1 to 24 hours.
- Please choose 'OK' to confirm the NTP setup, choose 'Cancel' to cancel.

NOTE

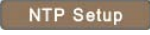
Check the box next to  to connect Time Zone setting with NTP Server. A user should set the Time zone correctly to operate the NTP function properly.

NOTE

Currently used NTP is administered by **pool.ntp.org**. However, users are allowed to use IP address of any NTP site. (If they have their own, otherwise leave the default Serve name.)

Time Zone

- Please Click (↔) Drop-down list of Time Zone to select correct time zone.

NTP Time

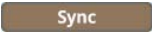
- Display NTP Server time, if Internet is connected to Time Server. If not displaying, please Click (↔) .
- When NTP Time's Clock is displayed, please Click (↔)  to synchronize NTP Server's clock with DVR clock.

NOTE

The displayed Server Time could be 30 minutes or 1 hour off from actual local time when the region is on Daylight Saving Time period. Just disregard it and sync the time. When you proceed to 'EXIT'. The very correct time should have been applied and displayed on DVR's screen.

DST

- Please Click (↔) Select box of DST to use Daylight Saving Time or not.
- If DST is (if different DST rule is) observed, please Click (↔)  and the following screen will display.

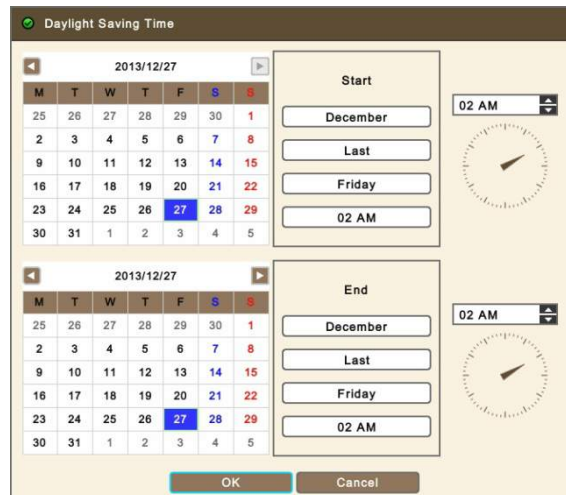

- Adjust the dates of Start and End for DST
- Please follow the procedure below for date adjustment. (Start & End)
 - ① Use arrow buttons in the Month Calendar to select date.
 - ▶: Move to next 'Month'
 - ◀: Move to previous 'Month'
 - ② Click (↔) a date. The date will be displayed in blue color
- Please follow the procedure below for time adjustment. (Start & End)
 - ① Adjust the number by Clicking (↔) ▲, ▼ buttons on the right-hand side.
- Please choose 'OK' to confirm the adjusted date and time, choose 'Cancel' to cancel.

Firmware

- Users may upgrade DVR when it is required.
- Please follow the Upgrade process below.
 - ① Plug USB memory stick which has a proper firmware file.
 - ② Click (↔) **Load New** Then, software version stored in the USB will display on the left-hand side.
 - ③ Click (↔) **Apply** to start the upgrade.
 - ④ Popup message box will display and ask to proceed. Click 'OK' to proceed.
 - ⑤ When the upgrade is completed, a message box will display. Please Click 'OK' button and DVR will auto-reboot.

NOTE

Upgrade file must be placed inside USB without folder. Otherwise SYSTEM will not be able to recognize the file.

CAUTION

DO NOT UPGRADE UNTIL A HARD DISK DRIVE IS INSTALLED. MAKE SURE TO UPGRADE WHEN HDD IS IN PROPER OPERATION.

CAUTION

PLUGGING OUT USB DEVICE OR FORCED POWER-OFF DURING VERSION UPGRADE MAY CAUSE PERMANENT DAMAGE.

Account

Group

- Please Click (↔) **New Group** and the following screen will display.



- Click (↔)  on the right-hand side of Group Name box or Group Name box. Then, the virtual keyboard will display.
- Please Click (↔) desired characters (up to 60 letters) on the virtual keyboard.
- Select access rights for the Group by checking some of the following items (All, Setup, Archiving, Shutdown, Search, Network, and Reboot). If Click (↔) 'All', all items are checked/unchecked at once.
- Please choose 'OK' to confirm the settings, choose 'Cancel' to cancel.
- To Edit the Group, Select a Group from the list and Click (↔) **Edit**
- To Delete the Group, Select a Group from the list and Click (↔) **Delete**

USER

- Please Click (↔) **New User** and the following screen will display.



- Click (↔) Drop-down list of Group Name to select a group
- Click (↔)  on the right-hand side of User ID frame or User ID box then virtual keyboard will display.
- Please Click (↔) desired characteristics (up to 60 letters) on the virtual keyboard.
- Input Password, Confirm and E-mail.
- Please choose 'OK' to confirm the settings, choose 'Cancel' to cancel.

- Then, lists of User will show as follows.

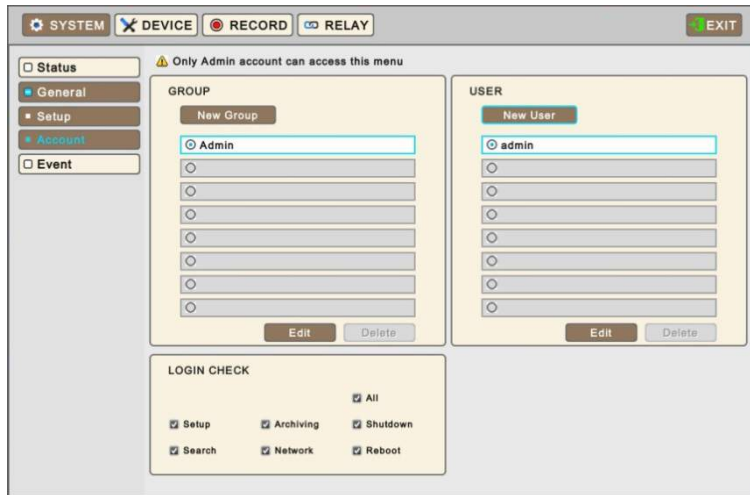

- To Edit the User, Select a User from the list and Click (↔) **Edit**
- To Delete the User, Select a User from the list and Click (↔) **Delete**

NOTE
Only 'Admin user' can access Account menu.

NOTE
E-mail address is not mandatory to create New User but it is necessary to send email notification.

NOTE
A user may create up to 8 Groups and 8 Users per Group.

Login Check

- Selectively enable password protection for important operations.
- Please check the operations that wish to enable password protection.

CAUTION
USERS WILL NOT BE ASKED TO ENTER THE PASSWORD FOR OPERATION(S) WHEN PASSWORD PROTECTION IS NOT ACTIVATED.

4.2.3 Event

- Please Click (↔) **SYSTEM>Event** and the following screen will display.

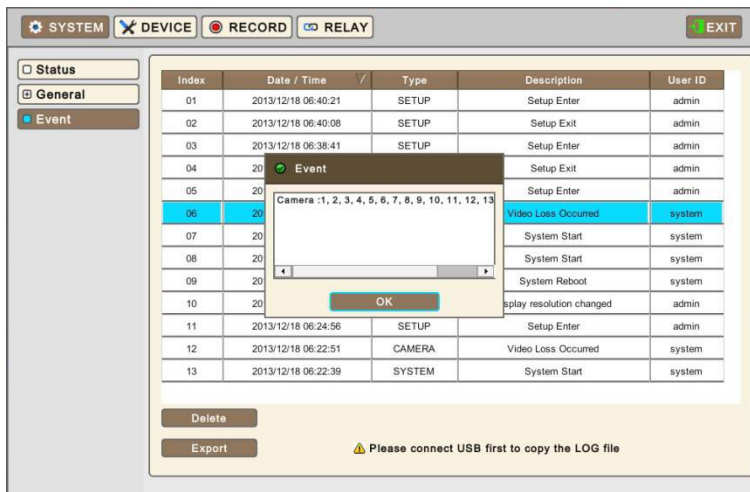

- System Log shows various event logs by User ID(s) like below
 - System Start
 - System Reboot
 - Setup Default/Import/Export
 - Resolution Change
 - Video out Change
 - Time Adjust Before/After
 - NTP Sync Success/Fail
 - Firmware Upgrade Success/Failure
 - Log Delete/Export
 - Setup Enter/Exit
 - Playback Start/Exit
 - Archive Success/Failure/Cancel
 - Video Loss Occur
 - Network Connect/Disconnect
 - Setup Change from Remote
 - E-mail Send Success/Failure
 - HDD Add/Remove/Relocate
 - HDD Format Success/Failure
 - Data Clear Success/Failure
 - S.M.A.R.T check Bad
 - HDD Rec Day On/Off
 - HDD Overwrite On/Off
 - DST On/Off
 - Lock On/Off
- Click (↔) Delete box to delete the log contents
- Click (↔) Export box to Export the log contents to USB memory stick.

NOTE
Maximum of 2,000 Event Log can be saved. After 2000 logs; older log will be deleted automatically.

NOTE
Users are able to sort the Event Log by Date/Time, Type, Description and User.

NOTE
Only Admin access right can delete the Log.

4.3 DEVICE

4.3.1 Display

- Please Click (←) **DEVICE>Display** and the following screen will display.

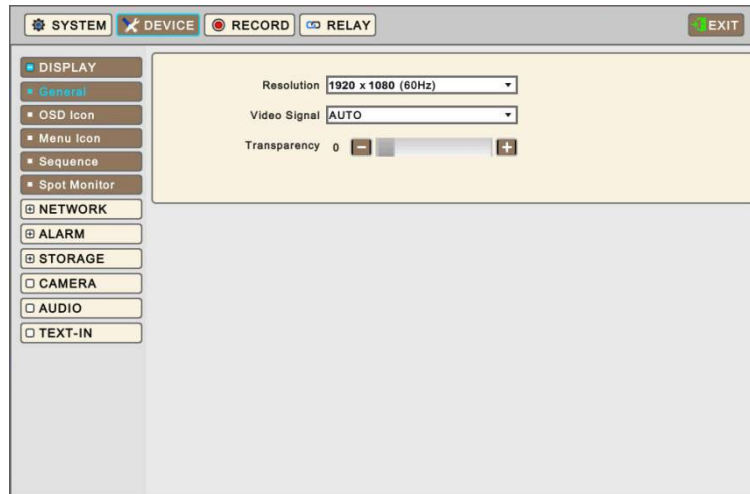

General

- Users are able to set its video output resolution between 1024 x 768 ~ 1920 x 1080.
- Video In / Out will help users to select its video input and output between NTSC, PAL and AUTO.
- The default value is 'AUTO'.
- Once the setting is changed, it will ask to reboot for the new recognition of video out.

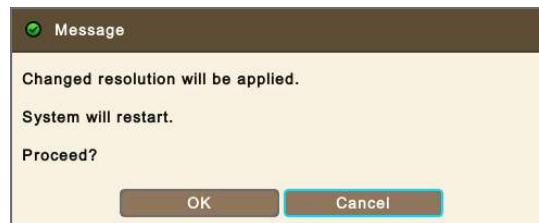

- Transparency option allows a user to adjust a level of transparency of menu display. Press (+) or (-) button to adjust the transparency

OSD Icon

- Please Click (←) **OSD Icon** and the following screen will display.

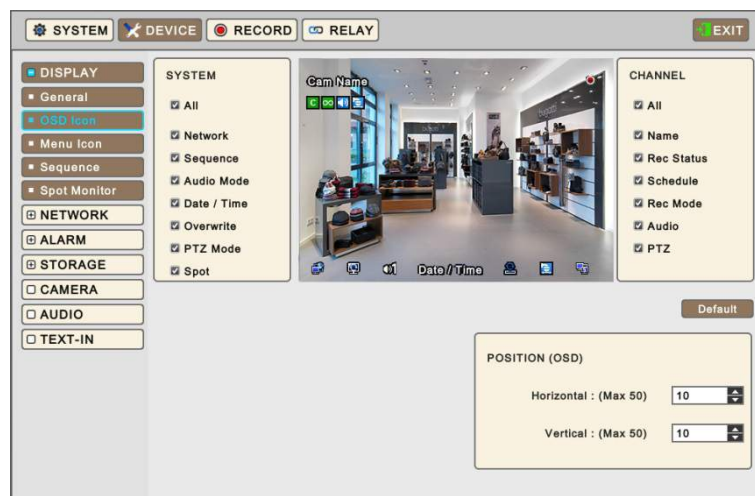

- The OSD Icon menu allows a user to select what to display on the screen.
- Click (←) **Default** to restore default value. (display all)

Position (OSD)

- Position (OSD) menu allows a user to adjust the position of Channel OSD on the monitor. Use it when some letters are dropped/invisible/blocked on the monitor.
- Adjust Horizontal to change margin between both ends of the monitor on horizontal side and OSD. Margin range is between **0 and 50**, with a larger number representing greater margin.
 - Use ▲, ▼ to adjust position of OSD
- Adjust Vertical to change margin between both ends of the monitor on vertical side and OSD. Margin range is between **0 and 50**, with a larger number representing greater margin.
 - Use ▲, ▼ to adjust position of OSD

Menu Icon

- Please Click (←) **Menu Icon** and the following screen will display.

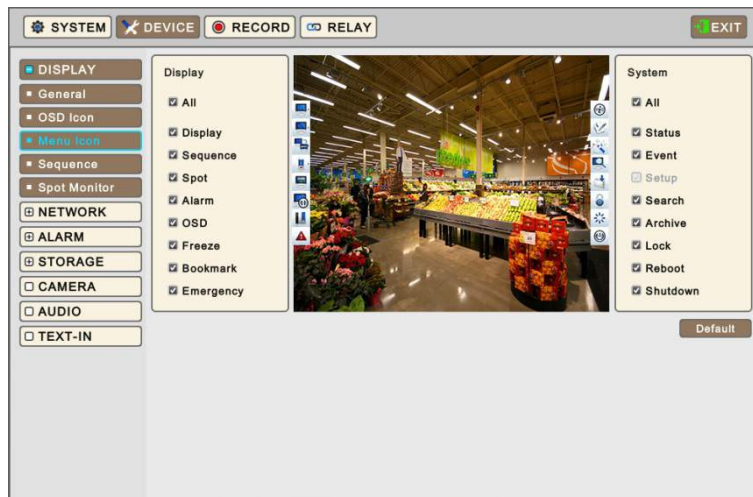

- The Menu Icon menu allows a user to customize the Left and Right side popup menu which is displayed on the screen by moving a mouse pointer on each side.
- Left side popup menu is for 'Display' options and Right side popup is for 'System' options. Click (←) 'All' selects/deselects all sub options.
- Click (←) **Default** to restore default value.

Sequence

- Please Click (←) **Sequence** and the following screen will display.

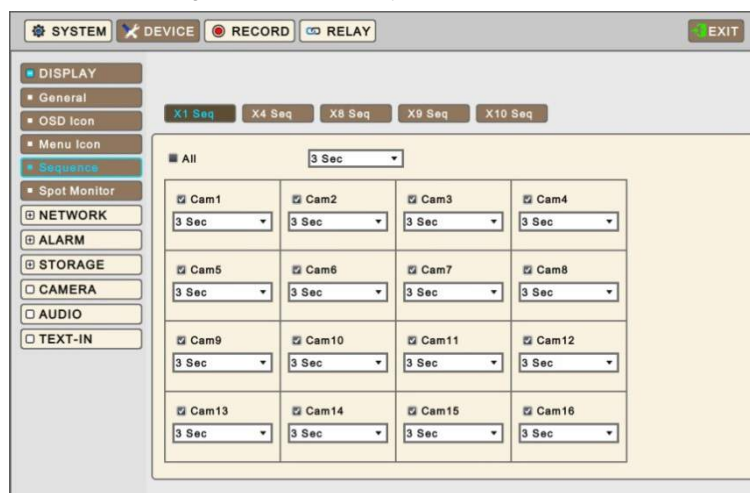

- The Sequence menu allows a user to adjust channel sequencing interval of Main monitor.
 - X1 Seq: Adjust interval for 'Full screen sequencing'.
 - X4 Seq: Adjust interval for '4 split screen sequencing'.
 - X8 Seq: Adjust interval for '8 split screen sequencing'.
 - X9 Seq: Adjust interval for '9 split screen sequencing'.
 - X10 Seq: Adjust interval for '10 split screen sequencing'.
- Check check box next to the camera that wish to include in sequencing. Any camera with unchecked check box will be excluded from channel sequencing.

- To adjust the location of the cameras for each sequence, Click (←) each Drop-down list and able to select the channel.
- To adjust the rotation interval of cameras, Click (←) each Drop-down list and select from **3, 5, 10, 15, 30 and 60 seconds**.
If Click (←) at the top Drop-down list in X1 Seq, Users can adjust all items of interval at once.



- To activate Sequence mode during live monitoring, click  to select the multi-channel split display mode on Display Menu Bar on the left margin of the main monitor.

NOTE

X8, X9, X10 Seq use only with 8/16 channel DVRs and x10 seq use only with 16 channel DVRs

Spot Monitor

- Spot or Multi Spot is only available in **S, A, B, C, D, G (4CH) and J Type**.
- This connection supports multi-channel display (1/4/8/9/10/16) on spot monitor depending on its channels (4/8/16).
- Please Click (←) **DEVICE>Display>Spot Monitor** and the following screen will display.

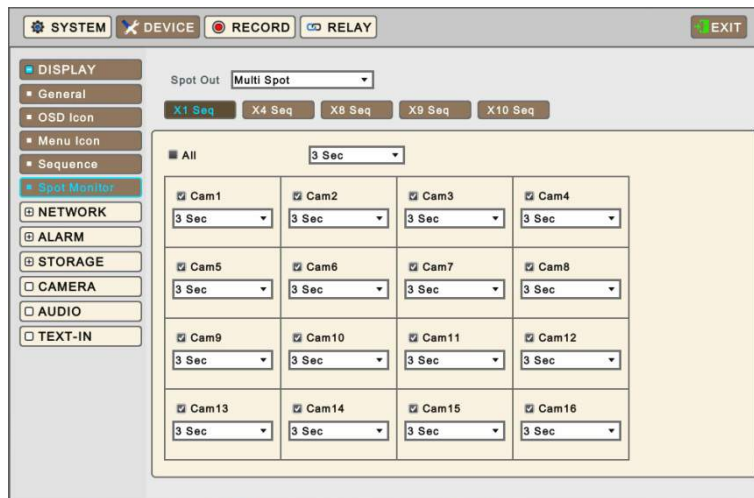

- To Select the type of spot out, Click (←) combo box (Users can select Multi spot or Spot).
- The Sequence menu allows a user to adjust channel sequencing interval of Spot Monitor.
 - X1 Seq: Adjust interval for 'Full screen sequencing'.
 - X4 Seq: Adjust interval for '4 split screen sequencing'.
 - X8 Seq: Adjust interval for 'Quad screen sequencing'.
 - X9 Seq: Adjust interval for '9 split screen sequencing'.
 - X10 Seq: Adjust interval for '10 split screen sequencing'.
- Check check box next to the camera that wish to include in sequencing. Any camera with unchecked check box will be excluded from channel sequencing.
- To adjust the location of the cameras during the sequence, Click (←) each Drop-down list and able to select the channel.
- To adjust the rotation interval of cameras, Click (←) each Drop-down list (Users can select **3, 5, 10, 15, 30 and 60 seconds**).
If Click (←) at the top Drop-down list in X1 Seq, Users can adjust all items of interval at once.

NOTE

X8, X9, X10 seq use only with 8/16 channel DVRs and x10 seq use only with 16 channel DVRs

4.3.2 Network

- Please Click (←) **DEVICES>Network** and the following screen will show.

LAN

LAN

- Please Click (←) Network Type. When you click the Drop-down list, users can select to Static (fixed IP) or DHCP (floating IP).
- In Static, a user must manually set the static IP address for use.
 - Set IP Address, Subnet Mask, Gateway DNS Server 1 & 2. Please ask your network administrator for more details.
 - To input address, please Click (←) Numpad icon on the right-hand side of each box.
- In DHCP, IP Address, Subnet Mask, Gateway and DNS Server will be assigned automatically from a Router.
- Register UPnP: Click (←) 'On' for automatic port forwarding and Click (←) 'Off' on radio box to do manual port forwarding.
- Bandwidth is to setup an average transfer speed.
- There are total of 14 different networks Bandwidth users may choose. (bps: bit per second) 26 kbps, 128 kbps, 256 kbps, 512 kbps, 1 Mbps, 2 Mbps, 4 Mbps, 8 Mbps, 10 Mbps, 20 Mbps, 40 Mbps, 80 Mbps, 100 Mbps and unlimited(default).
 - Ethernet support Max. 1000Mbps.

CAUTION

THE CONNECTED LOCAL ROUTER SHOULD SUPPORT AND ACTIVATE **UPnP** FEATURE ACCORDINGLY.

SMTP

- If users want to use “dvrdomain.com” which is offered by manufacturer instead of own SMTP server, please click on the check box (dvrdomain.com).
- To use own SMTP, Click (←) the check box on the left-hand side of Own SMTP box
- Click (←) the keyboard icon on the right-hand side of SMTP Server box and the virtual keyboard will display. Please register the SMTP Server. SMTP server can be set up by the users to have own SMTP server on their site.
- Click (←) the keyboard icon on the right-hand side of Sender ID box, Password and Email Sender then the virtual keyboard will display. Please register an ID to the sender mail server (e.g., ryu99).
- Default number of SMTP port is 25. Please note that any Internet Service Provider may have restrictions on the default port. If so, port number 2525 and 587 can be used alternatively.

CAUTION

DUE TO THE VARIOUS LOCAL JUNK MAIL POLICIES, EMAILING MAY NOT WORK PROPERLY. SSL EMAIL SERVERS MAY ALSO NOT WORK CORRECTLY. IF SO PLEASE DEACTIVATE THE SSL FEATURE IN THE (YOUR) SERVER SETUP. NOTE THAT SOME SERVER CANNOT DEACTIVATE THIS FEATURE

Port

- The Port Number Setup menu allows a user to configure Command, Stream and web port, when connecting to network users.
- Port number
 - **Command:** 5000~65535 (Default: 5920)
 - **Stream:** 5000~65535 (Default: 5921)
 - **Web:** 1~65535 (Default: 80)

CAUTION

IT IS NOT POSSIBLE TO CHANGE PORT NUMBER, WHEN A USER IS CONNECTED TO THE DVR VIA NETWORK.
ONCE PORT NUMBERS ARE CHANGED, IT MUST BE ALSO CHANGED THE PORT NUMBERS ON REMOTE SOFTWARE SUCH AS CMS Pro, mViewer Pro, iCMS and xCMS.

Dual Streaming

- To change Frame rate and qualities of dual streaming for Live monitoring, uncheck from the checkbox next to Default Value.
 - Frames : 1, 3, 5, 7, 15 frames for NTSC (1, 3, 5, 6, 12.5 frames for PAL)
 - Qualities : Low, Standard, High, Super

NOTE

Default Frame rate and Quality are 15 and High.

NOTE

Dual Streaming mode reduces network traffic and then show display more smooth at the low speed network environment.

DDNS

- Please Click (←) **DDNS** and the following screen will display.

- DDNS (Dynamic Domain Name System) service registers its unique Domain name to a provided server and allows a user to use the same address name to access the DVR. A user may use 3rd Party DDNS service if they have an account instead of dvrdomain.com.

Dvrdomain.com

- Check a checkbox of Dvrdomain.com to use dvrdomain.com.
- As for DDNS Server, Dvrdomain.com will be showing as default.
- Port number 95 will be shown as default. (It's possible to use 80 alternatively)

- By pressing the 'Get Domain Name', the DVR activates DDNS services and brings a registered DDNS name. A user may use this name as an IP address when they add a DVR on software.

NOTE

DDNS service port number 95 is NOT required to be port forwarded at all.

CAUTION

WHEN A USER'S CONNECTIONG DEVICES (PC, Mac, SMART PHONES, etc.) ARE UNDER THE SAME ROUTHER WITH A DVR, THE USER CANNOT USE THE DDNS NAME TO CONNECT. USE THE DVR'S PRIVATE IP ADDRESS FOR THIS CASE.

3rd Party DDNS

- Check a checkbox of 3rd Party to use dyndns.org or no-ip.com Server.
- As for DDNS Server, dyndns.org will be showing as default. To change server, Click (↔) Drop-down list of DDNS Server.

- As for Domain Name, users have to input the Domain Name given from the selected DDNS Server.
- As for ID and Password, use the user ID and Password to log in to the selected DDNS Server.
- Click "Run DDNS service" to start mapping from DVR to DDNS Server.

NOTE

Users must join 'dyndns.org' or 'no-ip.com' prior to using it as DDNS server. Please check corresponding website for more information.

NOTE

If system doesn't get domain name, please check network status.

NOTE

For the security reason, please change the admin's password other than the default

4.3.3 Alarm

Please Click (↔) **DEVICES>Alarm** and the following screen will display.

No.	Use	Name	Type
All	<input checked="" type="checkbox"/>	All	NC
1	<input checked="" type="checkbox"/>	AI 1	NC
2	<input checked="" type="checkbox"/>	AI 2	NC
3	<input checked="" type="checkbox"/>	AI 3	NC
4	<input checked="" type="checkbox"/>	AI 4	NC
5	<input checked="" type="checkbox"/>	AI 5	NC
6	<input checked="" type="checkbox"/>	AI 6	NC
7	<input checked="" type="checkbox"/>	AI 7	NC
8	<input checked="" type="checkbox"/>	AI 8	NC
9	<input checked="" type="checkbox"/>	AI 9	NC
10	<input checked="" type="checkbox"/>	AI 10	NC
11	<input checked="" type="checkbox"/>	AI 11	NC
12	<input checked="" type="checkbox"/>	AI 12	NC
13	<input checked="" type="checkbox"/>	AI 13	NC
14	<input checked="" type="checkbox"/>	AI 14	NC
15	<input checked="" type="checkbox"/>	AI 15	NC
16	<input checked="" type="checkbox"/>	AI 16	NC

Alarm In

- The Alarm In menu will allow users to give title and to select the type of Alarm input.
- Click (⌨) the keyboard icon on the right-hand side of each box on name column or name column and the virtual keyboard will display. Then, please register the title of Alarm input.
- When a check box is marked on Use, a corresponding Alarm starts operating. However, if a user does not check the check box, the operation stops. If Click (⌨) 'All' of use box, all items are check/uncheck at once.
- Click (⌨) each box on Type column to select type of a corresponding Alarm input. If Click (⌨) 'NC/NO' of Type column, all items can be changed NC/NO at once.
 - **NO**: contact is normally open
 - **NC**: contact is normally closed

Alarm Out

- Please Click (⌨) **Alarm Out** and the following screen will display.

No.	Use	Name	Type	Duration
All	<input checked="" type="checkbox"/>	All	NO	5 Sec
1	<input checked="" type="checkbox"/>	AO 1	NO	5 Sec
2	<input checked="" type="checkbox"/>	AO 2	NO	5 Sec
3	<input checked="" type="checkbox"/>	AO 3	NO	5 Sec
4	<input checked="" type="checkbox"/>	AO 4	NO	5 Sec
5	<input checked="" type="checkbox"/>	AO 5	NO	5 Sec
6	<input checked="" type="checkbox"/>	AO 6	NO	5 Sec
7	<input checked="" type="checkbox"/>	AO 7	NO	5 Sec
8	<input checked="" type="checkbox"/>	AO 8	NO	5 Sec
9	<input checked="" type="checkbox"/>	AO 9	NO	5 Sec
10	<input checked="" type="checkbox"/>	AO 10	NO	5 Sec
11	<input checked="" type="checkbox"/>	AO 11	NO	5 Sec
12	<input checked="" type="checkbox"/>	AO 12	NO	5 Sec
13	<input checked="" type="checkbox"/>	AO 13	NO	5 Sec
14	<input checked="" type="checkbox"/>	AO 14	NO	5 Sec
15	<input checked="" type="checkbox"/>	AO 15	NO	5 Sec
16	<input checked="" type="checkbox"/>	AO 16	NO	5 Sec
1	<input checked="" type="checkbox"/>	RO 1	NO	5 Sec
2	<input checked="" type="checkbox"/>	RO 2	NO	5 Sec

- The Alarm Out menu will allow a user to give title and to select the type of Alarm output.
- Click (⌨) the keyboard icon on the right-hand side of each box on name column or name column and the virtual keyboard will display. Then, please register the title of Alarm output.
- When a check box is marked on Use, a corresponding Alarm output starts operating. However, if a user does not check the check box, the operation stops. If Click (⌨) 'All' of use box, all items are check/uncheck at once.
- Click (⌨) each box on Type column to select type of a corresponding Alarm output. If Click (⌨) 'NC/NO' of Type column, all items can be changed NC/NO at once.
 - **NO**: contact is normally open
 - **NC**: contact is normally closed
- Users may change duration of all Alarm output.

4.3.4 Storage

- Please Click (⌨) **DEVICE>STORAGE** and the following screen will display.

No.	Information	Capacity	Used	Temp.	S.M.A.R.T	Format	Status
1	[P3] WDC ...	976 GB	38 GB	37 °C	OK	Yes	Writing

HDD Format

- This page shows information of HDDs installed in the DVR.
- When users install full storage device and DVD-RW including one e-SATA storage(**C, F, G H, I and J Type**), then following procedures will be listed as below:
 - 1. Internal SATA 1~4 Ports
 - 2. External SATA 1~4 Ports
 - 3. DVD-RW
- Under “Information”, it is possible to find the port number where each HDD is connected.
 - For Internal SATA, [P1], [P2], [P3] and [P4] each represents internal Port 1, Port 2, Port 3 and Port 4.
 - For External SATA, [E1], [E2], [E3] and [E4] each represents external Port 1, Port 2, Port 3 and Port 4.
- Users must format when:
 - install new HDD
 - add another HDD
 - replace HDD
 - move HDD (change installation port)
 - remove HDD
- Use to delete or purge all normal recorded data from database. Please follow the procedure below.
 - ① Click (←) Clear All Data box.
 - ② When a Message box asking “All the data will be deleted and cannot be restored. Proceed?” shows, choose ‘OK’ to confirm.
 - ③ Then, Progress window will display and the process starts.
 - ④ When all data are deleted, a message box “HDD format has been completed.” will pop up.

NOTE

When users add used HDDs from the same type of DVR, users can access data in DVRs as Read-Only or keep

CAUTION

DELETED DATA CANNOT BE RESTORED.

S.M.A.R.T

- Please Click (←) **S.M.A.R.T** and the following screen will display.

HDD Info.	ID	Name	Value	Worst	Threshold	Raw	Status
WD-WCAV9K825408	1	Raw_Read_Error_Rate	200	200	51	0	OK
WD-WCAV9K825408	3	Spin_Up_Time	124	119	21	6775	OK
WD-WCAV9K825408	4	Start_Stop_Count	100	100	0	297	OK
WD-WCAV9K825408	5	Reallocated_Sector_Ct	200	200	140	0	OK
WD-WCAV9K825408	7	Seek_Error_Rate	100	253	0	0	OK
WD-WCAV9K825408	9	Power_On_Hours	86	86	0	10756	OK
WD-WCAV9K825408	10	Spin_Retry_Count	100	100	0	0	OK

S.M.A.R.T

- S.M.A.R.T shows the status of HDD connected to the DVR.
- Click (←) Refresh box to refresh status of HDDs as the S.M.A.R.T setup.

Notification

- A user can set Notification when BAD are detected by S.M.A.R.T.
- Check Alarm out: users can set the alarm out, when “Bad” detects from HDDs. If Click (←) ‘All’, all items are check/uncheck at once.
- Check Email: users can receive the email notification to registered email address, when Bad detects from HDDs. If Click (←) ‘All’, all items are check/uncheck at once.

- Check Beep: When Bad detects from HDDs, it will give the alarm sound.
- Check Message: When Bad detects from HDDs, the alarm message will pop up on the OSD.

NOTE



When "Attention or Warning" is detected by S.M.A.R.T, notification (Alarm out, Email, Beep and Message) will not activate.

Overwrite

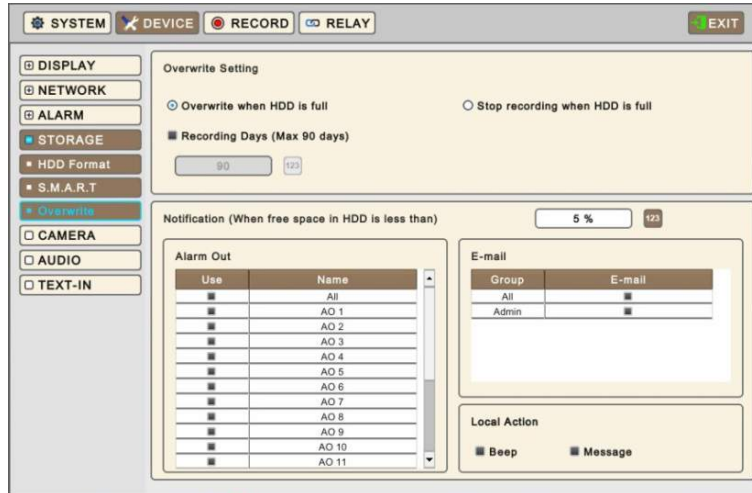
- Click (↔) Overwrite and the following screen will display.



Overwrite Setting

- Click (↔) Overwrite box and users may activate the overwrite function. (Overwriting mode is default)
 - This function makes restart the recording from the beginning when the HDD is full. The previous recorded data will be erased from the first one. Following icon will display in bottom of live mode. 
- A user shall designate the total recording days from 1 day to 90 days and unlimited.
- Click (↔) Stop recording box and users may deactivate the overwrite function.
 - Recording will stop automatically when the HDD is full.
 - At no Overwrite mode,  will display while the recording is going on.

Notification

- Users may set the certain value of HDD usage for notification. It will notify, when free space in HDD is less than the specified value. The values are from 0 ~ 100%
- Check Alarm out: users can set the alarm out, when free space in HDD is less than the specified value. If Click (↔) 'All', all items are check/uncheck at once.
- Check E-mail: users can receive the email notification to registered email address, when free space in HDD is less than the specified value. If Click (↔) 'All', all items are check/uncheck at once.
- Check Beep: a DVR makes beeping sound when free space in HDD is less than the specified value.
- Check Message: the warning message "Free space in HDD is less than (xx%)!" will display on the OSD

CAUTION

IF USERS USE "Recording Days" FUNCTION, DVR WILL STORE ONLY THE DAYS THAT SPECIFIED BY USERS AND STOPS RECORDING. PLEASE BEWARE OF DATA LOSS DUE TO "Rec Days" FUNCTION.

NOTE

Notify setting does not affect saving the recorded data. It only gives notification and keep recording until hard disk is full.

NOTE

For more specific setting about Alarm-out, use **Setup>DEVICE>ALARM>Alarm Out**.

4.3.5 Camera

- Please Click (←) **DEVICE>CAMERA** and the following screen will display.

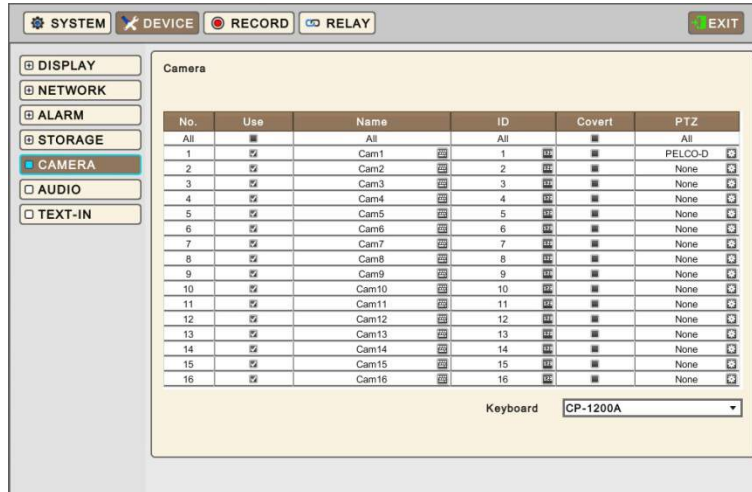

- Click (←) the each Name box and the virtual keyboard will display. Then, register names of cameras.
- If a check box is checked on Use column, a video of the corresponding camera is recorded and displayed on the monitor. However, if a user does not check the checkbox, "UNUSE" text will be displayed on the channel. If Click (←) 'All', all items are check/uncheck at once.
- Click (←) the each ID box and the virtual Numpad will display. Then, set ID Number of Cameras (i.e., 0 ~ 9999). The assigned ID will be used for RS485/RS422/PTZ operations if applicable.
- If a check box is checked on Covert box, a video is recorded but is not displayed on the monitor. If Click (←) 'All', all items are check/uncheck at once.
- Click (←) each PTZ Column to set PTZ Settings connected to a corresponding camera. And the following screen will display.

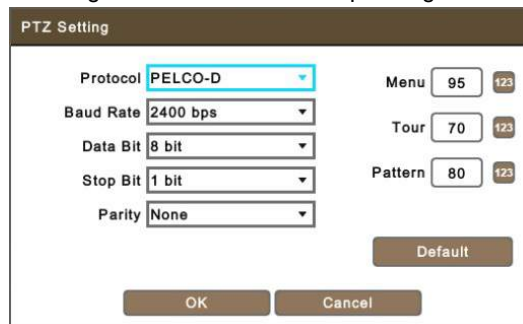

- Click (←) Drop-down list of Protocol / Baud Rate / Data Bit / Stop Bit / Parity to set PTZ settings of the Camera
- Menu, Tour and Pattern help users to use OSD function of PTZ camera.
 - IF a PTZ camera itself supports OSD menu, use the setup values to enter and use the OSD menu using the DVR interface.
 - If OSD entering command is 95 + PSET for example, designate 95 for Menu item,
 - If shortcut key to use Tour function is 71 ~79 + PSET, designate 70 for Tour item and
 - If shortcut key to use Pattern function is 81 ~ 89 + PSET, designate 80 for Pattern item.
 - The setting information herein is used for **PAN / TILT control** in 5.1.5 (to be described).
 - For further details on settings, please refer to the PTZ camera manual. Every PTZ camera manufacturer may have a different setting on above. Please contact PTZ camera manufacturer for special preset reservation.
- If users Click (←) **Default**, PTZ setting restores its default.
- Please choose 'OK' to confirm settings and choose 'Cancel' to cancel.
- Click (←) Drop-down list of keyboard to select keyboard. This is used when a user uses Keyboard Joystick for DVR(s) and PTZ Camera(s). You may disregard when you connect PTZ camera(s) to a Keyboard Joystick directly

NOTE

When using RS-485 over Coax for **S, A, B, C, I (Analog) and J Type**, users can select any protocol from the Protocol list other than 'NONE'. If 'NONE' is selected then RS-485 over Coax will not work. The PTZ camera should supports RS-485 over Coax feature to work with.

4.3.6 Audio

• Please Click (←) **DEVICES>Audio** and the following screen will display.

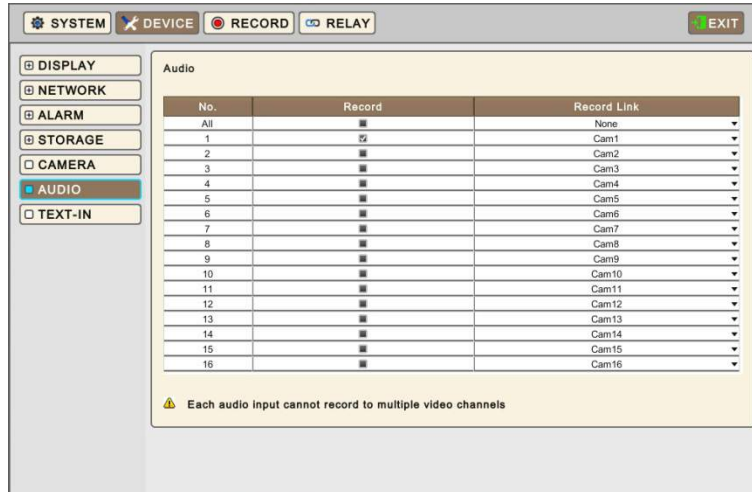

- The Audio menu allows a user to choose whether to record Audio, if connected
- When a check box is marked on Record column, corresponding audio and video from Linked Camera will be recorded. However, if the check box is not marked, audio will not record. And If Click (←) 'All', all items are check/uncheck at once.
- Click (←) Drop-down list of Record Link to select Linked cameras

CAUTION

AN AUDIO INPUT CANNOT BE LINKED TO 2 OR MORE VIDEO CHANNELS.

4.3.7 Text-In

NOTE

Please refer to "12. TEXT-IN".

4.4 RECORD

4.4.1 Record

- A DVR has 5 different types of recording mode as followings. A user may combine those 5 and apply by hour basis.
 - **Continuous:** record continuously.
 - **Motion:** record only when motion is detected.
 - **Alarm:** record only when Alarm In is detected.
 - **Emergency:** record when a user presses **Emergency** key. (Front panel, Remote controller, Mouse selection)
 - **Pre-Event:** record before Motion, Alarm and Emergency event triggered.

• Below lists show the maximum recording rate of a DVR by recording resolution.

-960H Type- (Maximum Recording Rate by Resolution)

S (4, 8CH), A, B, C and D Type

NTSC (PAL)	360x240 (360x288)	720x240 (720x288)	720x480 (720x576)	960x480 (960x576)
4 Channel DVR	120 (100)	120 (100)	120 (100)	120 (100)
8 Channel DVR	240 (200)	240 (200)	240 (200)	240 (200)
16 Channel DVR	480 (400)	480 (400)	480 (400)	480 (400)

-HD-SDI Type- (Maximum Recording Rate by Resolution)

E and F Type

30/60hz (25/50hz)	960x480 (960x576)	1280 x 720	1920 x 1080
4 Channel DVR	30 (25) fps per Channel	30 (25) fps per Channel	30 (25) fps per Channel
8 Channel DVR	30 fps per Channel	30 fps per Channel	15 fps per Channel
16 Channel DVR	30 fps per Channel	30 fps per Channel	15 fps per Channel

G Type

30/60hz (25/50hz)	960x480 (960x576)	1280 x 720	1920 x 1080
4 / 8 / 16 Channel DVR	30 (25) fps per Channel	30 (25) fps per Channel	30 (25) fps per Channel

H Type

30/60hz (25/50hz)	960x480 (960x576)	1280 x 720	1920 x 1080
4 / 8 Channel DVR	60 (50) fps per Channel	60 (50) fps per Channel	60 (50) fps per Channel

I Type

•HD-SDI Input (CH 1 ~ 4)

30/60hz (25/50hz)	960x480 (960x576)	1280 x 720	1920 x 1080
4 Channel	30(25) fps per Channel	30(25) fps per Channel	30(25) fps per Channel

• Analog Input (CH 5 ~ 16)

NTSC (PAL)	360x240 (360x288)	720x240 (720x288)	720x480 (720x576)	960x480 (960x576)
12 Channel	360 (300)	360 (300)	360 (300)	360 (300)

J Type (True Hybrid - All Channel Hybrid)

•HD-SDI & Analog Input (CH 1 ~ 16)

30/60hz (25/50hz) & NTSC (PAL)	960x480 (960x576)	1280 x 720	1920 x 1080
8 / 16 Channel	30(25) fps per Channel	30(25) fps per Channel	30(25) fps per Channel

NOTE

The actual displayed frame could be different by camera signal frequency (Hz, HD-SDI) and/or local standard (PAL/NTSC, Analog)

Except E (8/16), F (8/16) Type.

- HD-SDI: 1, 3, 5, 7, 15, 25, 50 (25 Hz & 50 Hz) / 1, 3, 5, 7, 15, 30, 60 (30 Hz & 60 Hz)
- Analog: 1, 3, 5, 6, 12.5, 25, 50 (PAL) / 1, 3, 5, 7, 15, 30, 60 (NTSC)

NOTE

E, F, G, H, I and J Type DVRs can detect 1080i, 1080p or 720p HD-SDI signals. If a user connects cameras before the booting, each signal is automatically detected and recognized (Auto Detection).

NOTE

Please reboot the DVR, when switch from HD-SDI to Analog or Analog to HD-SDI (**J Type only**)

CAUTION

IF A USER CONNECTS DIFFERENT TYPES OF HD-SDI SIGNALS WHILE DVR IS OPERATING, IT MAY CAUSE MALFUNCTIONS OF DVR.

Continuous

- Please Click (↔) **Continuous** and the following screen will display.

No.	Name	Resolution	Frame	Quality
All	All	960 x 480	30	High
1	Cam1	960 x 480	30	High
2	Cam2	960 x 480	30	High
3	Cam3	960 x 480	30	High
4	Cam4	960 x 480	30	High
5	Cam5	960 x 480	30	High
6	Cam6	960 x 480	30	High
7	Cam7	960 x 480	30	High
8	Cam8	960 x 480	30	High
9	Cam9	960 x 480	30	High
10	Cam10	960 x 480	30	High
11	Cam11	960 x 480	30	High
12	Cam12	960 x 480	30	High
13	Cam13	960 x 480	30	High
14	Cam14	960 x 480	30	High
15	Cam15	960 x 480	30	High
16	Cam16	960 x 480	30	High

- The Continuous menu allows a user to set occasional recording rates and resolution.
- Each box on Title column shows camera title registered in **DEVICES>Camera**. A user cannot change camera titles here.
- Click (↔) each box on Resolution column to select recording resolution of a corresponding camera. A user may select one of **360x240(288), 720x240(288), 720x480(576), 960x480(576), 1280x720 and 1920x1080**.
- Click (↔) each box on Frames column to select recording rate of a corresponding camera. Recording rate varies by selected recording resolution.
- Click (↔) each box on 'Quality' column to select recording quality of a corresponding camera. A user may select its recording quality from **Super, High, Standard and Low**.
- Click (↔) Drop-down list to change the setting values of Resolution, Frames, Quality. And If Click (↔) Drop-down list of all box, All items are changed at once

Motion

- Please Click (↔) **Motion** and the following screen will display.

No.	Name	Resolution	Frame	Quality	Post Rec
All	All	960 x 480	30	High	10 Sec
1	Cam1	960 x 480	30	High	10 Sec
2	Cam2	960 x 480	30	High	10 Sec
3	Cam3	960 x 480	30	High	10 Sec
4	Cam4	960 x 480	30	High	10 Sec
5	Cam5	960 x 480	30	High	10 Sec
6	Cam6	960 x 480	30	High	10 Sec
7	Cam7	960 x 480	30	High	10 Sec
8	Cam8	960 x 480	30	High	10 Sec
9	Cam9	960 x 480	30	High	10 Sec
10	Cam10	960 x 480	30	High	10 Sec
11	Cam11	960 x 480	30	High	10 Sec
12	Cam12	960 x 480	30	High	10 Sec
13	Cam13	960 x 480	30	High	10 Sec
14	Cam14	960 x 480	30	High	10 Sec
15	Cam15	960 x 480	30	High	10 Sec
16	Cam16	960 x 480	30	High	10 Sec

- The Motion menu allows a user to set Motion based recording rates and resolution.
- Each box on Title column shows camera title registered in **DEVICES>Camera**. A user cannot change camera titles here.
- Click (↔) each box on Resolution column to select recording resolution of a corresponding camera. A user may select one of **360x240(288), 720x240(288), 720x480(576), 960x480(576), 1280x720 and 1920x1080**.
- Click (↔) each box on Frames column to select recording rate of a corresponding camera. Recording rate varies by selected recording resolution.
- Click (↔) each box on 'Quality' column to select recording quality of a corresponding camera. A user may select its recording quality from **Super, High, Standard and Low**.
- Click (↔) each box on 'Post Rec' column to select recording duration (**10 seconds ~ 10 minutes**) of a corresponding camera.
- Click (↔) Drop-down list to change the setting values of Resolution, Frames, Quality and Post Rec. And If Click (↔) Drop-down list of all frame, All items are changed at once

Alarm

- Please Click (←) **Alarm** and the following screen will display.

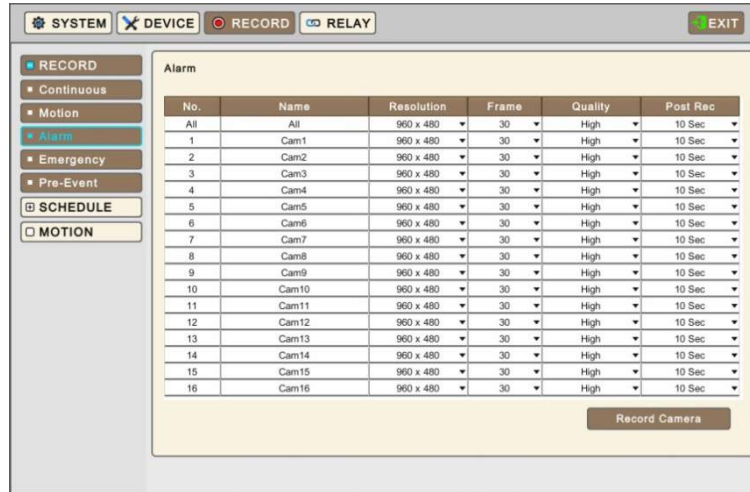

- The Alarm menu allows a user to set Alarm based recording rates and resolution.
- Each box on Title column shows camera title registered in **DEVICES>Camera**. A user cannot change camera titles here.
- Click (←) each box on Resolution column to select recording resolution of a corresponding camera. A user may select one of **360x240(288), 720x240(288), 720x480(576), 960x480(576), 1280x720 and 1920x1080**.
- Click (←) each box on Frames column to select recording rate of a corresponding camera. Recording rate varies by selected recording resolution.
- Click (←) each box on 'Quality' column to select recording quality of a corresponding camera. A user may select its recording quality from **Super, High, Standard and Low**.
- Click (←) each box on 'Post Rec' column to select recording duration (**10 seconds ~ 10 minutes**) of a corresponding camera.
- Click (←) Drop-down list to change the setting values of Resolution, Frames, Quality and Post Rec. And If Click (←) Drop-down list of all frame, All items are changed at once

NOTE

E, F, G, H, I and J Type DVRs can detect 1080i, 1080p or 720p HD-SDI signals. If a user connects cameras before the booting, each signal is automatically detected and recognized (Auto Detection).

CAUTION

IF A USER CONNECTS DIFFERENT TYPES OF HD-SDI SIGNALS WHILE DVR IS OPERATING. IT MAY CAUSE MALFUNCTIONS OF DVR.

Record Camera

- Click (←) **Record Camera** to change the setting of Alarm in Record Camera and the following screen will display.



- A user can manually choose which cameras to record when Alarm In occurs.
- Please choose 'OK' to confirm the setting and choose 'Cancel' to cancel.

Emergency

- Please Click (↔) **Emergency** and the following screen will display.

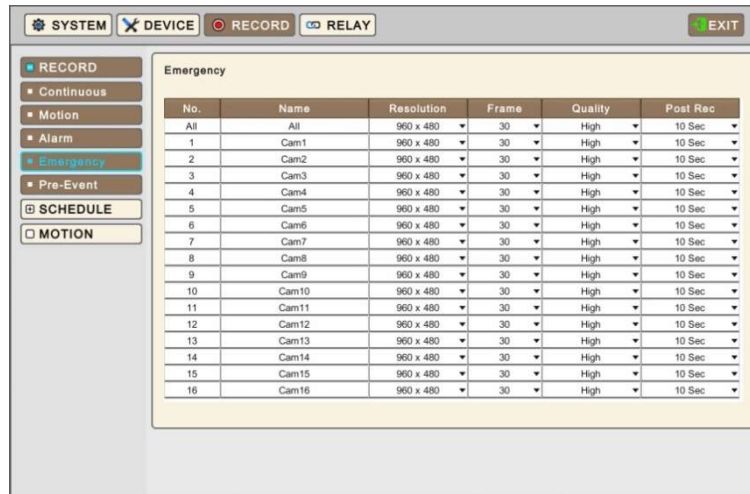

- The Emergency menu allows a user to set Emergency based recording rates and resolution, when 'Emergency button pressed.
- Each box on Title column shows camera title registered in **DEVICES>Camera**. A user may not change camera titles here.
- Click (↔) each box on Resolution column to select recording resolution of a corresponding camera. A user may select one of **360x240(288), 720x240(288), 720x480(576), 960x480(576), 1280x720 and 1920x1080**.
- Click (↔) each box on Frames column to select recording rate of a corresponding camera. Recording rate varies by selected recording resolution.

Pre-Event

- Please (↔) **Pre-Event** and the following will display.



- Pre-Event is effectively used when a user selects recording mode by Motion, Alarm or Emergency.
- Pre-Event feature allows a user to make a DVR to record at the same conditions as defined at Motion, Alarm, and Emergency for a period of 'up to' actual event triggered time.
- Please follow the setup procedures below.
 - ① Click (↔) Drop-down list of Duration box to select recording duration (**10 second ~ 10 minutes**)
 - ② Click (↔) Drop-down list of "Record follows" to apply the same Recording Setting of Motion, Alarm or Emergency for a period as defined above.

NOTE

Pre-Event recording conditions are dependent on Motion, Alarm or Emergency which is configured by the user.

4.4.2 Schedule

- Please Click (←) **RECORD>Schedule** and the following will display.

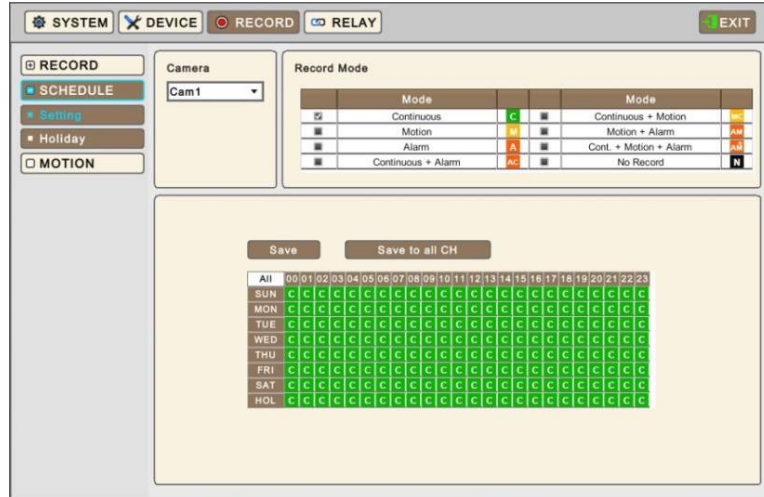

Setting

- The Schedule table displays one week divided by hour and date. Each cell represents one hour. A user may choose appropriate recording conditions by hour. Holidays could be defined by a user separately.
- Click (←) Drop-down list of Camera box to select Camera.
- Please set the recording mode as follows:
 - ① Mark a check box to select record mode in record mode table.
 - ② Click block, row, column to register desired recording mode.
 - Click (←) a cell and only the cell will be registered.
 - Click (←) a row (SUN~HOL) and the entire row will be registered.
 - Click (←) a column (00~23) and the entire column will be registered.
 - ③ Click (←) Save button to save setting
- Click and hold mouse cursor on the Schedule table and then brush as you want. The brushed cells will be registered as your record mode selection.
- Repeat the procedure for Camera No. 2 to 16. If a user wants all other cameras to have the same mode, please Click (←) Save to all CH button.

Holiday

- Please Click (←) Schedule>Holiday and the following screen will display.

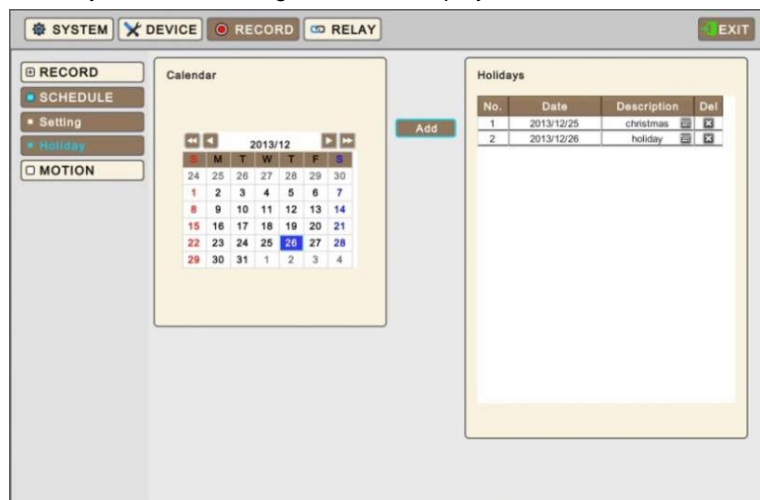

- The Holiday menu allows a user to register holidays. Please follow the registration procedure below.
 - ① Use arrow buttons in the Month Calendar to select Year and Month of holiday to be registered.
 - ►►: Move to next 'Year'
 - ◀◀: Move to previous 'Year'
 - ►: Move to next 'Month'
 - ◀: Move to previous 'Month'

- ② Click (↔) on date needed to be registered as holiday.
 - ③ Click (↔) ADD button and Virtual keyboard will display to input description of holiday
 - ④ Please choose 'OK' to confirm the input and the date will be copied to the Holidays table.
 - ⑤ If wish to delete the registration of a certain holiday, please Click ☒ button next to the Holiday table.
- Since holidays may vary every year, we recommend user to update on a regular basis.

4.4.3 Motion

- Please Click (↔) **RECORD**>**Motion** and the following screen will display.

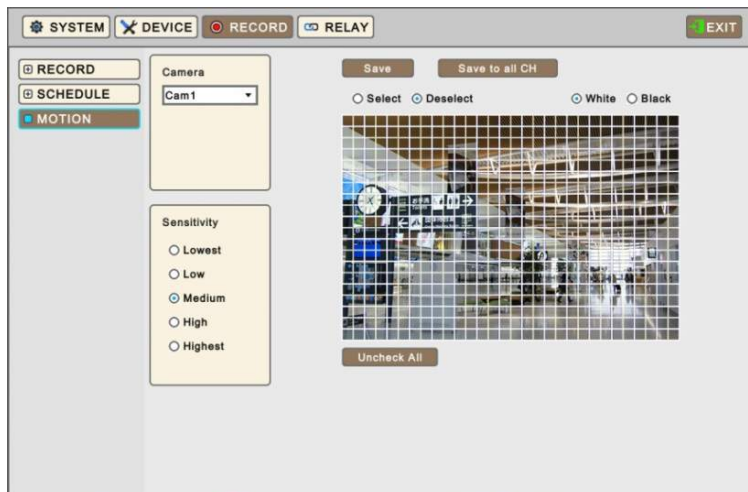

- Click (↔) Drop-down list of Camera box to select Camera.
- Please set the motion detection area as follows:
 - ① Select Sensitivity in Sensitivity box (Lowest, Low, Medium, High and Highest)
 - ② Click (↔) **Uncheck All** to Deselect the area first.
 - ③ Click (↔) 'Select' and will be able to select the area of detection on the grid.
 - ④ Click blocks to activate.
 - ⑤ Click (↔) Save button to save setting
- Drag and Drop Mouse Cursor on Blocks and rows/columns to select/unselect the areas.
- Repeat the procedure for Camera No. 2 to 16. If a user wants every camera to have the same mode, please Click (↔) "Save to all CH" button.
- Click (↔) White or Black to change color of line on the grid.

4.5 RELAY

- Please Click (↔) **RELAY** and the following screen will display.

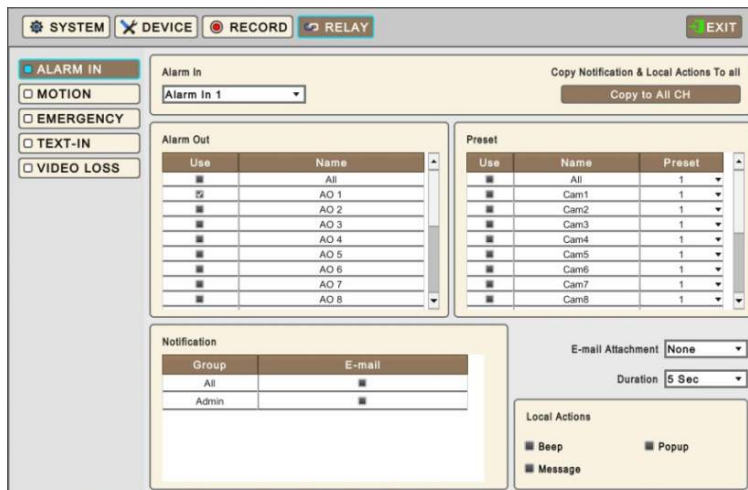

- The Relay menu allows a user to setup action plans when events (Alarm In, Motion, Emergency, Text-In, and Video Loss) happen. A user may activate Alarm Out, PTZ Preset, Email Notification, Beeping, OSD popup and Message by those.

4.5.1 ALARM IN

- Select Alarm out, Preset and Notification to use when Alarm In sensor goes off.
- Link Notification displays E-mail addresses registered in **System>General>Account>User>Email**
- Please follow the setup procedures below.
 - ① Click (←) Drop-down list of Alarm In box and select Alarm In.
 - ② Select Alarm out to be worked when selected Alarm In is on. Please check a check box of use column on Alarm Out box. More than one alarm outputs can be set. If Click (←) 'All' of use box, all items are checked/unchecked at once.
 - ③ Select cameras for preset when Alarm In is on. Please check a check box of use column on Preset box. More than two cameras can be set. If Click (←) 'All' of use box, all items are checked/unchecked at once
 - ④ Click (←) Drop-down list of Preset to change Cameras preset. If Click (←) Drop-down list of all preset box, all items are changed at once
 - ⑤ Select group for notification when Alarm In is on. Please check a check box of E-Mail box. More than two Groups can be set.
 - ⑥ Click (←) Drop-down list of E-mail Attachment box to attach None, JPGE or EXE
 - ⑦ Click (←) Drop-down list of Duration column to set the duration of recorded data for attached EXE
 - ⑧ Select Local Actions
 - Beep: When Alarm In is on, it will give the alarm sound
 - Popup: When Alarm In is on, it will make the popup screen on the main monitor
 - Message: When Alarm In is on, the alarm message will pop up on the OSD
 - ⑨ Repeat the above procedure for Alarm In 2~ Alarm In 16 (Up to 2 for **A and E(4CH) Type** / Up to 4 for **B and E(8, 16CH) Type** / Up to 8 for **I Type** / Up to 16 for **C, D, F, G, H and J Type**).
- Click (←) Copy to All CH button to copy Notification & Local Actions to all channels.
- To select cameras for recording when alarm In is on, Please change setting in **Record>Recording>Alarm>Record camera**

4.5.2 MOTION

- Please Click (←) **RELAY>MOTION** and the following screen will display.

The screenshot shows the MOTION configuration screen with the following details:

- Camera:** Cam 1
- Copy Notification & Local Actions To all:** Copy to All CH
- Alarm Out Table:**

Use	Name
<input checked="" type="checkbox"/>	All
<input type="checkbox"/>	AO 1
<input type="checkbox"/>	AO 2
<input type="checkbox"/>	AO 3
<input type="checkbox"/>	AO 4
<input type="checkbox"/>	AO 5
<input type="checkbox"/>	AO 6
<input type="checkbox"/>	AO 7
<input type="checkbox"/>	AO 8
- Preset Table:**

Use	Name	Preset
<input checked="" type="checkbox"/>	All	1
<input type="checkbox"/>	Cam1	1
<input type="checkbox"/>	Cam2	1
<input type="checkbox"/>	Cam3	1
<input type="checkbox"/>	Cam4	1
<input type="checkbox"/>	Cam5	1
<input type="checkbox"/>	Cam6	1
<input type="checkbox"/>	Cam7	1
<input type="checkbox"/>	Cam8	1
- Notification Table:**

Group	E-mail
All	<input checked="" type="checkbox"/>
Admin	<input checked="" type="checkbox"/>
- E-mail Attachment:** None
- Duration:** 5 Sec
- Local Actions:**
 - Beep
 - Message
 - Popup

- Select Alarm out, Preset and Notification to use when a motion is detected on cameras.
- Link Notification displays E-mail addresses registered in **System>General>Account>User>Email**
- Please follow the setup procedures below.
 - ① Click (←) Drop-down list of camera box and select Camera.
 - ② Select alarm outputs to be worked when Motion of selected Camera is detected. Please check a check box of use column on Alarm Out frame. More than two alarm outputs can be set. If Click (←) 'All' of use box, all items are checked/unchecked at once
 - ③ Please check a check box of use box on Preset frame. More than two cameras can be set. If Click (←) 'All' of use box, all items are checked/unchecked at once
 - ④ Click (←) Drop-down list of Preset to change Cameras preset. If Click (←) Drop-down list of all preset box, all items are changed at once
 - ⑤ Select group for notification when Cam 1 is detected Motion. Please check a check box of E-Mail box. More than two Groups can be set.
 - ⑥ Click (←) Drop-down list of E-mail Attachment box to attach None, JPEG or EXE

- ⑦ Click (↔) Drop-down list of Duration box to set the duration of recorded data for attached EXE
- ⑧ Select Local Actions
 - Beep: When selected Camera detects Motion, it will give the alarm sound
 - Popup: When selected Camera detects Motion, it will make the popup screen on the main monitor
 - Message: When selected Camera detects Motion, the Motion message will pop up on the OSD
- Repeat the above procedure for Cam 2~ Cam 16
- Click (↔) Copy to All CH button to copy Notification & Local Actions to all channels.

4.5.3 EMERGENCY

- Please Click (↔) **RELAY>EMERGENCY** and the following screen will display.

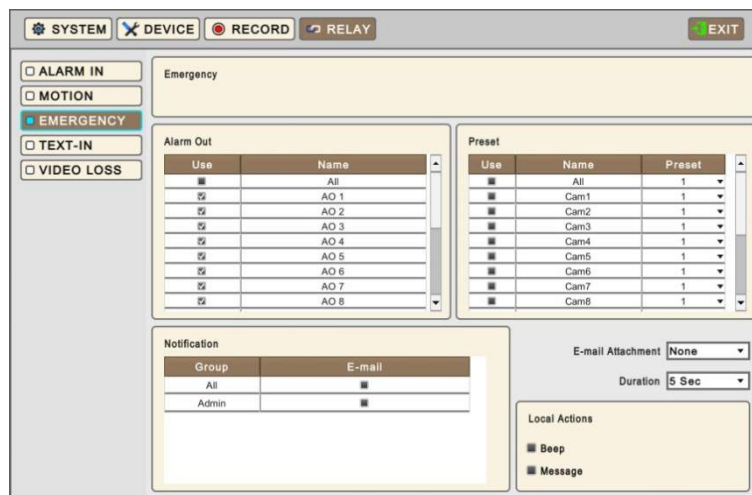

- Select Alarm out, Preset and Notification to use when Emergency button pressed.
- Link Notification displays E-mail addresses registered in **System>General>Account>User>Email**
- Please follow the setup procedures below.
 - ① Select alarm outputs to be worked when Emergency button is pressed. Please check a check box of use column on Alarm Out box. More than two alarm outputs can be set. If Click (↔) 'All' of use box, all items are checked/unchecked at once
 - ② Please check a check box of use column on Preset box. More than two cameras can be set. If Click (↔) 'All' of use box, all items are checked/unchecked at once
 - ③ Click (↔) Drop-down list of Preset to use Cameras preset. If Click (↔) Drop-down list of all preset box, all items are changed at once
 - ④ Select group for notification when video loss is occurred. Please check a check box of E-Mail box. More than two Groups can be set.
 - ⑤ Click (↔) Drop-down list of E-mail Attachment box to attach None, JPEG or EXE.
 - ⑥ Click (↔) Drop-down list of Duration column to set the duration of recorded data for attached EXE
 - ⑦ Select Local Actions
 - Beep: When Emergency is occurred, it will give the alarm sound
 - Message: When Emergency is occurred, the Emergency message will pop up on the OSD

4.5.4 TEXT-IN

• Please Click (↔) **RELAY>TEXT-IN** and the following screen will display.

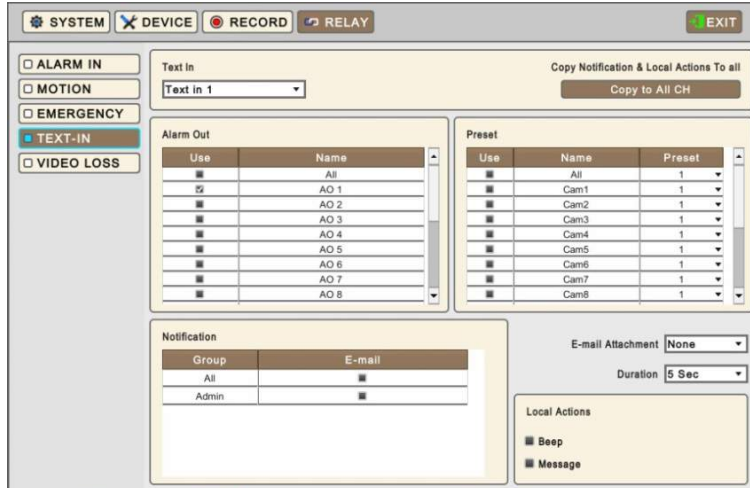

- Select cameras for Preset, Alarm Out and Notification to use when Text In comes to DVR. (PTZ Preset is frequently used for this case).
- Link Notification displays E-mail addresses registered in **System>General>Account>User>Email**
- Please follow the setup procedures below.
 - ① Click (↔) Drop-down list of Text In box and select Text 1.
 - ② Select alarm outputs to be worked when Text In 1 is on. Please check a check box of use column on Alarm Out box. More than two alarm outputs can be set. If Click (↔) 'All' of use box, all items are checked/unchecked at once.
 - ③ Select cameras for preset when Text In 1 is on. Please check a check box of use column on Preset frame. More than two cameras can be set. If Click (↔) 'All' of use column, all items are checked/unchecked at once
 - ④ Click (↔) Drop-down list of Preset to change Cameras preset. If Click (↔) Drop-down list of all preset box, all items are changed at once
 - ⑤ Select group for notification when Text In 1 is on. Please check a check box of E-Mail box. More than two Groups can be set.
 - ⑥ Click (↔) Drop-down list of E-mail Attachment box to attach None, JPEG or EXE.
 - ⑦ Click (↔) Drop-down list of Duration box to set the duration of recorded data for attached EXE.
 - ⑧ Select Local Actions
 - Beep: When Text In 1 is on, it will give the alarm sound
 - Message: When Text In 1 is on, the alarm message will pop up on the OSD
- Repeat the above procedure for Text In 2~ Text In 4
- Click (↔) Copy to All CH button to copy Notification & Local Actions to all channels.

4.5.5 VIDEO LOSS

• Please Click (↔) **RELAY>VIDEO LOSS** and the following screen will display.

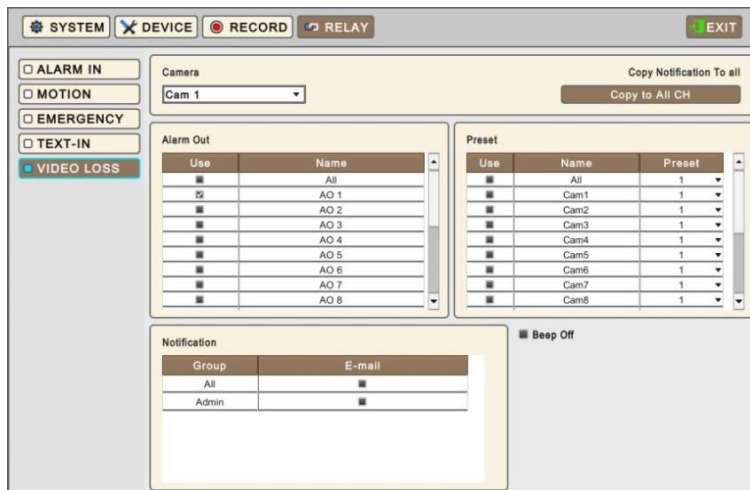

- Select Alarm out, Preset and Notification to use when Video Loss occurs on each channel.

• Link Notification displays E-mail addresses registered in **System>General>Account>User>Email**

• Please follow the setup procedures below.

⑨ Click (↔) Drop-down list of camera box and select Cam 1.

⑩ Select alarm outputs to be worked when video loss is occurred to cam 1. Please check a check box of use column on Alarm Out box. More than two alarm outputs can be set. If Click (↔) 'All' of use box, all items are checked/unchecked at once

⑪ Select cameras for preset when video loss is occurred to cam 1. Please check a check box of use column on Preset box. More than two cameras can be set. If Click (↔) 'All' of use box, all items are checked/unchecked at once

⑫ Click (↔) Drop-down list of Preset to change Cameras preset. If Click (↔) Drop-down list of all preset box, all items are changed at once

⑬ Select group for notification when video loss is occurred to cam 1. Please check a check box of E-Mail box. More than two Groups can be set.

• Repeat the above procedure for Cam 2 ~ Cam 16.

• Click (↔) Copy to All CH button to copy Notification to all channels.

• Click Beep Off to deactivate alert sounds from video loss. Apply to all channels.

5. OPERATION INSTRUCTION

5.1 Viewing

5.1.1 First Image

- Power on DVR and the attached cameras (if any) will display.

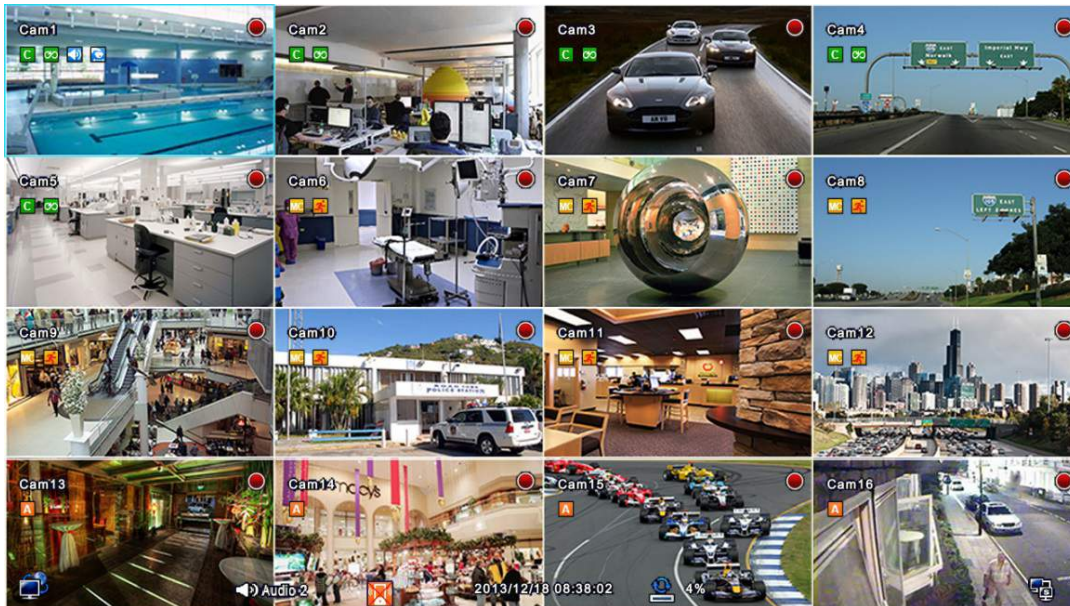

- The screen will display date/time and icons below.

Icon	Description	Icon	Description
	Continuous recording schedule		Continuous + Motion recording schedule
	Motion recording schedule		Motion + Alarm recording schedule
	Alarm recording schedule		Cont. + Motion + Alarm recording schedule
	Continuous + Alarm recording schedule		No Record
	Continuous recording mode		Motion recording mode
	Alarm recording mode		Emergency recording mode
	Audio recording		PTZ registration
	In recording		Remote access indication/ No. of accesses (up to 16)
	In channel sequencing		Audio channel
	Master Alarm Enabled		Date / Time
	HDD Overwriting Enabled		HDD Overwriting Disabled (Recording)
	Estimated HDD usage		Keyboard controller mode
	PTZ mode		Spot out Enabled

• On the right bottom side of the screen, disk usage will show by %.

• On the left top side of each channel screen   icon will show as its operation.

• At the normal state, HDD Overwrite mode is on and  icon shows.

• When Overwrite mode is off at **DEVICE>STORAGE>Overwrite**,  will show.

• Click Emergency recording button,  icon will show.

• Click Audio button,  icon will show. And Click Audio button again to reactivate the Audio.

NOTE

Note that the audio on/off is NOT for RECORDING. This button selection is for Audio out to DVR's 'Line/Sppeaker Out'.

5.1.2 View Format

• The available view formats when the Main Monitor is in viewing mode include Full Screen (Single channel View), Split Screen, Channel Sequencing Screen and PIP screen.

– **Full Screen:** Please press camera select key (**1~16**) to view the corresponding camera image in full view format.

NOTE

Using a mouse: Double Click to view the corresponding camera image in full view format and Double Click again to back to Split Screen.

– **Split Screen:** Please press **DISPLAY** key  and the available split screens (or multi-window view formats) will display alternately (i.e., 1, 4, 8, 9, 10, 16).

– **Channel Sequencing:** Please press **SEQUENCE** key  to display images in sequencing view format periodically. This automatic sequence function is not limited to the full screen format, but can be used in any view mode. In 8 channels DVR, 1 or 4-camera sequencing view mode is possible and in 16 channels DVR, 1, 4, 8, 9 or 10-camera sequencing view modes are possible.

5.1.3 Digital Zoom

- Select a Channel into Full Screen.
- Drag a portion to zoom by mouse.
- Double Click mouse to exit zoomed screen.
- This function works only in the full screen. A user cannot use the digital zoom function in split screen format, channel sequencing or PIP mode.

5.1.4 Freeze Live Image









- Press **FREEZE** key  while viewing live image to pause the image.
- The Freeze function works only in the full screen or split screen formats. Please do not use this function in channel sequencing mode or in PIP mode.

5.1.5 Pan / Tilt / Zoom Control

- Press **PTZ** key to operate a PTZ camera connected to DVR. PTZ operations are only available in the full screen format.





- In Pan/Tilt mode, the  icon is displayed on the bottom of the screen.
- Please refer the below for PTZ OSD menu.

Key	Function
   	Up/Down/Left/Right rotation
	Zoom out
	Zoom in
	Focus Far
	Focus Near
	Iris Close
	Iris Open
	Save Preset
	Go to the Preset
	Go to OSD main menu
	Run Group Tour 1~9
	Run Pattern 1~9

- To use a mouse in Pan/Tilt mode, select and double click a channel first. Right Click on selected channel to open Channel menu then Click “PTZ” to activate PTZ control OSD menu. A key pad control will show as follows:



- To add new preset, select Preset No and  button Click.
- To move to preset, select preset No and  button Click.

- Available 1 ~ 255 Preset numbers can be saved it depends on camera specification.
- Press Menu button to pop-up PTZ camera OSD setup screen and set up Tour and Pattern items.
 - Since these functions make use of a memory function of the camera itself, a user should set them in Camera OSD.
 - Once a user completes the setup, close the Camera OSD menu.
 - A user can conveniently use Tour and Pattern functions simply by Clicking Tour and Pattern buttons.
 - Please refer the PTZ camera manual for instruction of Tour and Pattern.

NOTE

Suppose a command for using Tour function is 71 ~ 79 + Preset and if you had set Tour to 70 (See Section 4.3.5), use Preset No: 1 ~ 9 + Tour button to activate the Tour function (70 + 1~9).

NOTE

It is required to set Menu as Preset number 95 from camera in order to call camera menu display by Clicking 'menu' button or using 95+Goto button. Please refer the PTZ camera manual for details.

5.1.6 System Log

- Please Press  key and the System Log screen will display.



Index	Date / Time	Type	Description	User ID
01	2013/12/18 10:11:12	SYSTEM	NTP Sync : Failure	system
02	2013/12/18 09:11:12	SYSTEM	NTP Sync : Failure	system
03	2013/12/18 08:38:03	CAMERA	Video Loss Occurred	system
04	2013/12/18 08:37:51	CAMERA	Video Loss Occurred	system
05	2013/12/18 08:37:36	CAMERA	Video Loss Occurred	system
06	2013/12/18 08:37:06	SETUP	Setup Exit	admin
07	2013/12/18 08:26:12	CAMERA	Video Loss Occurred	system
08	2013/12/18 08:11:12	SYSTEM	NTP Sync : Failure	system
09	2013/12/18 07:46:48	SETUP	Setup Enter	admin
10	2013/12/18 07:29:48	SYSTEM	System Start	system
11	2013/12/18 07:14:32	SETUP	Setup Enter	admin
12	2013/12/18 07:11:20	SYSTEM	System Start	system
13	2013/12/18 06:40:21	SETUP	Setup Enter	admin
14	2013/12/18 06:40:08	SETUP	Setup Exit	admin

Buttons: Delete, Export, Close

Warning: Please connect USB first to copy the LOG file

- System Event shows all logs of actions taken by users.



5.1.7 Key Lock

- Press  to operate the key lock function. This function is indicated by  icon in the center of the screen.
- Once the Key Lock function is activated, a user cannot use any key. If wish to use a key, please enter the correct password to release the key lock function.

5.1.8 Emergency Recording

- When a user presses **EMERGENCY** key or , recording starts right away regardless of the recording mode. A user can modify the Emergency recording conditions. **SETUP> RECORD > EMERGENCY**

5.1.9 Alarm Out Control and Acknowledge

- Press  and will be able to activate Acknowledge or Open Alarm out Control.
- Press  to instantly disable Alarm out signal.
- Press  to open alarm out control window to manually activate Alarm out.

5.2 Playback



- Press **SEARCH** key on the System Menu Bar, or Press Search button on the front of the DVR and the following Search menu will display.



- There are two ways to search video, i.e., by Calendar and by event.

- Calendar Search: search by using calendar.
- Event Search: search by event.

- There are three other functions in playback mode;



- This function allows a user to take screenshot and save to USB in jpeg format.



- The Archive function allows a user to copy the recorded video in EXE or AVI format to a storage device (USB memory stick or DVD-RW). Refer to **5.5 Archive** for more information



- Able to access the saved Bookmarks and play the data from the marked time. Refer to **5.4 Bookmark** for more information.



- Able to show the color coding of the time bar. Each color represents different recording mode.



- Playback mode runs in the available maximum number of split screen format. To change the viewing mode, please press **DISPLAY** key or **Camera Select** key (1~16).









NOTE

Using a mouse: Double Click to view the full screen and double Click one more time to back to Split Screen.

NOTE

Pushing a wheel of mouse: Enter Playback mode.

• Following is the key usage found in playback mode. A user may also use the keypad provided on the screen.

Go to Start		• Go to start of recorded data
REW		• Fast backward playback (changes up to x128 with each press)
BACKWARD		• Frame-by-frame reverse still image playback
PLAY		• Playback mode: 1X PLAY
PAUSE		• PAUSE
FORWARD		• Frame-by-frame forward still image playback
FF		• Fast forward playback (changes up to x128 with each press)
Go to End		• Go to end of the recorded data



• Press key to leave the playback mode.

5.2.1 Search



• Press key on the System Menu Bar, or Press Search button on the front of the DVR and the following Search menu will display.



- There are two ways to search video, i.e., by calendar and by event.
 - **Calendar Search:** search by using calendar.
 - **Event Search:** search by event.

Calendar Search

• As enter Search mode following will display.

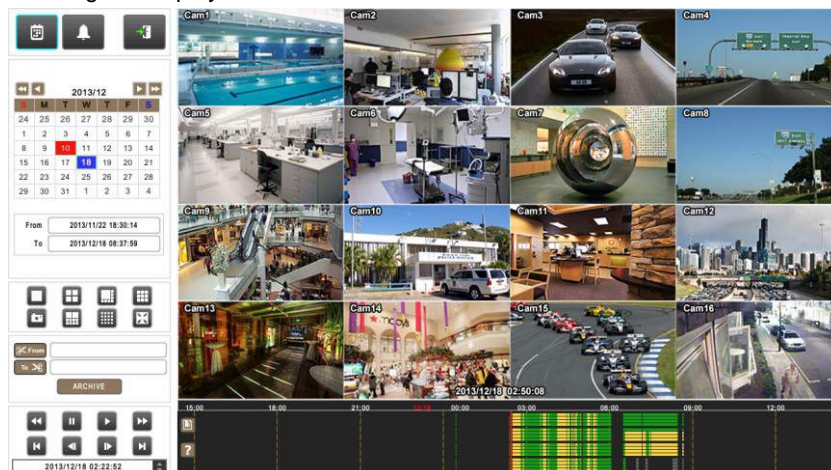

- Please Click (+) Calendar to do Calendar Search. (Default display)
- Dates and Time with recorded data available will be high-lighted in Red color.

• Follow the procedure below to search video by calendar.

- ① Select Year and Month by using the arrow buttons in the calendar.
 - ►►: Move to next 'Year'
 - ◀◀: Move to previous 'Year'
 - ►: Move to next 'Month'
 - ◀: Move to previous 'Month'
- ② Click (↔) on a certain date wish to playback. The date will be displayed in Blue color.
- ③ Click (↔) on the time bar and Red line will move to the selected time and playback will begin instantly.

NOTE

Time period on the time indication bar can be adjusted by mouse **scroll**. It can be adjusted by 1 min to 3 hour time duration blocks.



• If you don't use mouse or front button while the DVR is playing recorded data, the DVR would stop playback in 10 minutes automatically.

Event Search

• This Event Search is useful when a user set up event recording like Motion, Alarm In (if any), Text In (if any), and Emergency.

• Please Click (↔)  to do Event Search.

• Press  on the side and the following Date / Time Setup menu will display.

Date / Time Setup

Date: 2013/12/17 ~ 2013/12/18

Time: 04:14:44 ~ 04:14:44

CH01 CH02 CH03 CH04 CH05 CH06 CH07 CH08
 CH09 CH10 CH11 CH12 CH13 CH14 CH15 CH16

Event Search POS/ATM Search

Motion Alarm Emergency

- ① Select Event Search start Date and Time.
- ② Select Event Search end Date and Time.
- ③ Select cameras (video) to be included. One or more cameras can be selected.
- ④ Choose 'Event Search' and select specific event(s) to be included. Or choose 'POS/ATM Search' then virtual keypad is display. Type a keyword to search by.
- ⑤ Click "OK" to search the recorded data for selected event and key word transactions.
- ⑥ Searched data will be listed on the side.

NOTE

When selecting camera, more the one camera can be selected.

5.2.2 Digital Zoom in Playback

- Users are able to use Digital Zoon function in full screen playback.
- Drag a partition on to the screen, then the partition will enlarge as a full screen.
- Double Click the left button of mouse to exit the zoom-in screen.

5.2.3 One-touch Playback

- Press the **PLAY/PAUSE** key or Click the mouse wheel (central button) in the viewing mode. Then, a user will be able to view the recorded video right away without going through the search procedure. The video plays back the recorded video from the last three minutes. To stop playing back the video, please press  key.

5.3 Menu Bar

















- Menu bar enables users to control all features as front button.



- Move mouse cursor to Left and Right margin of the screen to access Menu Bar during live monitoring.

Display Menu Bar (Left Margin)

System Menu Bar (Right Margin)

Icon	Description	Icon	Description
	Main monitor Display (1/4/8/9/10/16)		General Status
	Activate Sequencing mode (1/4/8/9/10)		Open Event Log
	Multi Spot (1/4/8/9/10/16/None)		Enter Setup mode
	Disable Alarm out / Alarm Out control		Enter Search Mode
	OSD On / Off		Enter Archive mode
	Freeze Live Image		Activate Key Lock
	Bookmark		System Restart
	Activate Emergency recording		System Shut Down



5.4 Bookmark

- Bookmark allows a user to save certain time during both live monitoring and playback mode. And able to go back to the bookmarked time during playback.



- Press  in both Live and Playback mode and the following popup window will display.

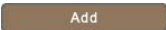

- In Live, it is only possible to add the current time to the list. Please enter Name for each of the Bookmark time. A user can check the list in playback.
- In Playback, it is possible to add, delete and play from the Bookmark List. Press  to add the current (in playing) time to the list. Press  to delete added bookmark from the Bookmark List. To do playback double Click on the bookmarked time from the list.

5.5 Archive

- The Archive function allows a user to copy the recorded video from DVR to a storage device (USB memory stick, DVD-RW).
- Please execute Archive at both Live and Playback.
- Follow the procedure.







- ① Press **ARCHIVE**  key during live monitoring or  during Playback. Then, the following screen will display.

Archive

CH01
 CH02
 CH03
 CH04
 CH05
 CH06
 CH07
 CH08
 CH09
 CH10
 CH11
 CH12
 CH13
 CH14
 CH15
 CH16

From : Device :
 To : Format :
 File Name :

- ② Check a check box next to a camera with the video that want to store. A user can archive multi-channel at the same time. (only EXE format, one channel only for AVI format)
- ③ Click (←) the   on the right-hand side of FROM box to set the storage start time.
- ④ Click (←) the   on the right-hand side of TO box to set the storage end time.
- ⑤ Click (←) Format box to select EXE or AVI.
- ⑥ Click (←) Device box to select a storage device out of USB and CD/DVD-RW.
- ⑦ Click (←) the keyboard display on the right-hand side of File Name box to input a file name. A user does not need to input extension (exe, avi). Please note that the file is not going to be stored unless user inputs a name.
- ⑧ To set a Password to the file that users want to save, mark the check box of "use Password". Then, Click the keyboard button and set a password.
- ⑨ Click (←) OK button. Then, Progress bar will display and the storage process proceeds. The progress bar may not show actual progress time. Depending on the file size, it may restart even after it shows 100%. It is important not to detach storage device until DVR displays "Archive Success" or "Failure" message.
- ⑩ If the archiving is done properly, Archive Success message will pop up. Please choose 'OK' to confirm. If the storage fails, Archive Fail message will pop up. In this case, a user may try again.

NOTE

To archive in jpeg format please use snapshot in Playback mode.

NOTE

Please do not change the settings by DVR or CMS, while archiving.

NOTE

Please enter all the necessary information before Click 'OK'.

NOTE

If the total archiving file size exceeds 2GB then the new archived file will be produced every 2GB. From the second file it will have Date and time stamp of the starting time after the original file name given by the user.

If the total archiving file exceeds the capacity of the media then the popup message will display once the maximum capacity of the media is reached. Please change the media and press "OK" to proceed.

CAUTION

PLEASE DO NOT USE THE SPACE WHEN ENTER BACKUP FILE NAME.

CAUTION

DURING ARCHIVE PROCEDURE, PLEASE DO NOT DETACH STORAGE DEVICE OR POWER OFF THE DVR. OTHERWISE, IT MAY CAUSE PERMANENT DAMAGE TO THE DVR OR THE STORAGE DEVICE. IN SUCH CASE, A USER MUST REBOOT THE DVR. IF THE DVR DOES NOT OPERATE PROPERLY, A USER MIGHT NEED TO CONTACT SERVICE CENTER.

CAUTION

WHEN ARCHIVING IN AVI FORMAT, IT ONLY SUPPORTS 1CH AND DOES NOT SUPPORT PASSWORD FEATURES.

CMS Pro
Full-featured Enterprise Class Surveillance Solution

User`s Manual



6. CMS Pro

6.1 CMS Pro Features

6.1.1 Introduction

- The CMS Pro is a central surveillance system solution that monitors multiple sites with video, audio and event signals from DVRs over networks.
- The software supports different windows of live viewer, playback player, interactive map viewer, various search panes and event signal monitoring panes.

6.1.2 Features

- This program does not limit the number of units to register and monitor. The program displays up to 512 live videos; up to 256 channels on one screen and 256 channels on the other screen. The program supports as many monitors as a PC supports. Users may open windows or panes of live video displaying, data playing, event signal monitoring, map displaying, etc. Users can compose the central management system by choosing required widows or panes.
- The software supports different windows of live viewer, interactive map viewer, and event signal monitoring panes.
- The program displays event signals in real-time by connecting to devices over the network.
- On the program, users may control PTZ cameras and relay outputs on the server or DVR. By attaching microphone and speaker system to devices on site, users may make bi-directional audio communication over the network.
- The map supports multi-layer structure, so that each map on different layers can respond interactively. On the map, users may lay out icons of each device. Event signal triggers the icons on the map to blink, so that users may monitor event signals on the map. And Users can check the live view of individual camera on the map by clicking the video icon.
- With 5 different types of search function, users can search the recorded data according to user's needs.

WARNING

DUE TO A LIMITATION OF A PC, CONNECTING MORE THAN 16 HD-SDI (FULL HD) CAMERAS MAY RESULT IN MALFUNCTIONING OF THE SOFTWARE. TO CONNECT MORE THAN 16 HD-SDI (FULL HD) CAMERAS, PLEASE ENABLE DUAL STREAMING OPTION ON THE DVR.

6.1.3 System Requirements

- CMS Pro may not run properly if the PC does not meet minimum requirements. Other programs should not run on the same PC where this is running. Otherwise, CMS Pro software may not perform as designed.

	Minimum	Recommended
CPU	Intel Core i5	Intel Core i7
Main Memory	2GB	4GB or higher
Video Memory	1GB	2GB or higher
Display Resolution	1024 x 768 (with 32bit color) or higher	
HDD Storage Space	160GB or higher	
Network	100~1000 Mbps Fast Ethernet	
Operating System	Windows XP Professional SP3 / Windows 7 (32/64) / Windows 8 (32/64)	
Others	DirectX 9.0 C or higher	

6.2 Installation

6.2.1 Software Installation

- Please follow the program installation procedures below.
 - ① If an old version of CMS Pro program was installed, it is recommended to completely uninstall or delete the old version.
 - ② Insert the provided CD in a PC.
 - ③ Run the CMS Pro Setup.exe file.
 - ④ When the following screen appears, click “Next.”

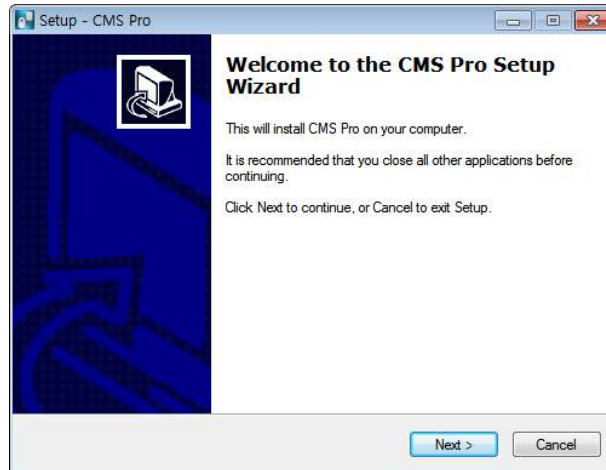

- ⑤ When the following screen appears, select folder and click “Next.”

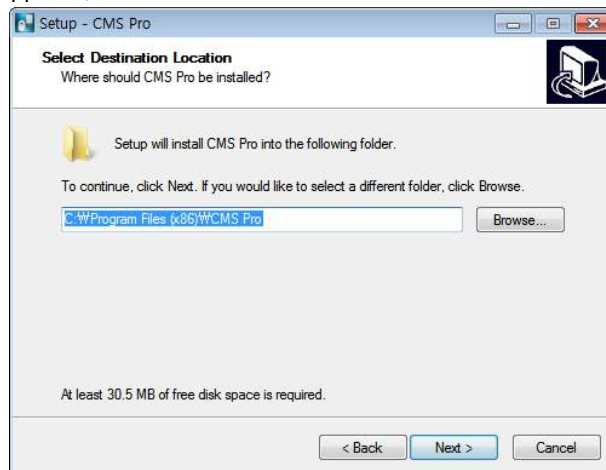

- ⑥ When the following screen appears, select the check box according to user's preference and click “Next.”

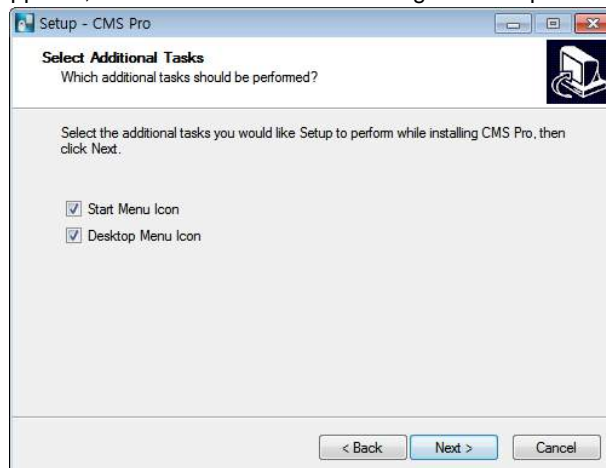

⑦ When the following screen appears, click “Install.”

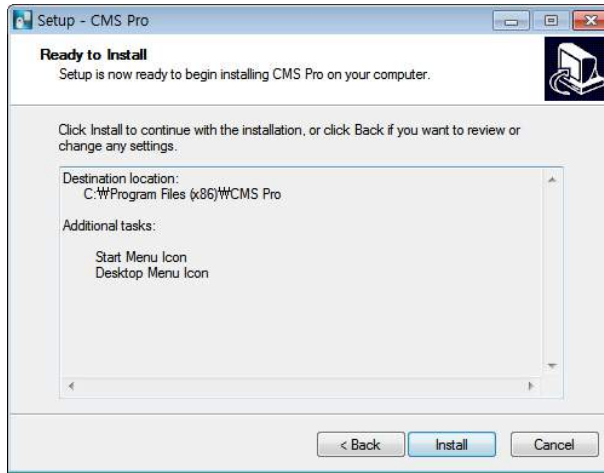

⑧ When the following screen appears, click “Finish” to complete the installation.



NOTE

If the PC has a previously installed CMS Pro, the installer may ask whether to overwrite the existing DB or not. The DB contains setting values on the program. If desired to maintain the existing values, click 'No' button.

6.2.2 Login

6.2.2.1 Login Process

- Open the CMS Pro. Users may open it by selecting the execution file through 'Start' menu [Start] – [CMS Pro] or by double-clicking the execution icon on the desktop.
- Select a user ID in the 'Login' window. Users may see the entire list of IDs that are registered into the program by clicking on the drop-down menu in the right-side. Initially, only the Administrator is registered as default.



- Enter the corresponding password with the selected ID. The default password of the 'Admin' ID is '1111'. Administrator may change the password in the program.



NOTE

Users may change the password in [Setup] – [Change Password] menu. For the detailed information, please refer to the 'Chapter 6.4.7 Change Password' page.

The CMS Pro saves settings and layouts on the program of the current user when the program is closed.

6.3 Menu

- Below shows the brief explanation of each part on the screen.

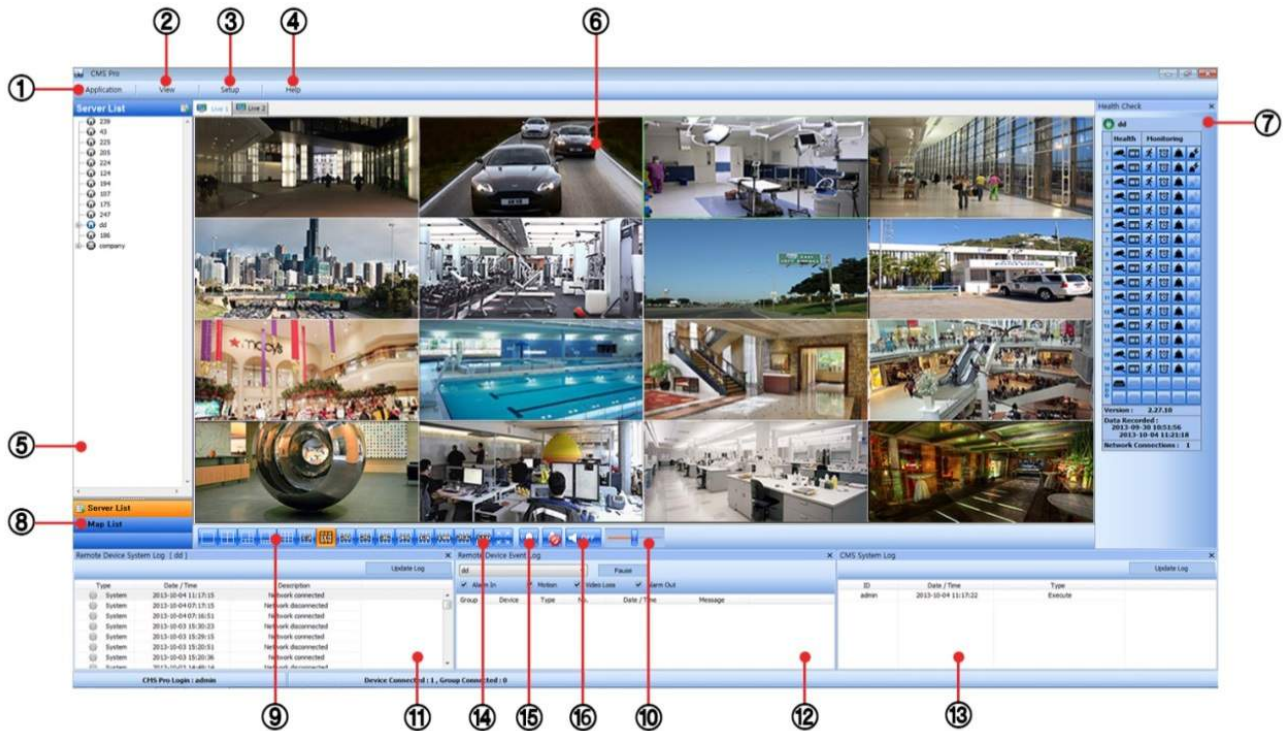

1	Application
2	View set
3	Setup menu
4	Help menu
5	Server list pane
6	Display windows
7	Health check pane
8	Map list pane
9	Screen split selection icons
10	Audio control bar
11	Remote device system log pane
12	Remote device event log pane
13	CMS system log pane
14	Sequencing
15	Event Beep On / Off
16	Audio Status icon

6.4 Setup

6.4.1 Local Setup - Device

- Please make sure the network setting of DVR has been done properly prior to the remote connection setting.

6.4.1.1 Remote Site Connection Setup

- Click Setup – Local Setup – Device to enter the setup and a dialog will pop up as below picture.



6.4.1.2 New Device Register

Device

- Select “Device Connection List” on left-hand side and click [New] to register new devices.

- Describe the connection information as below. A user must fill in where information requested in **bold**.
 - **Device Name:** Type the DVR name to be displayed in the server list pane. Please note that this name has no relation to the ID registered in DVR. Users may create a name to be easily distinguished.
 - **Description:** Type brief description of the site
 - **IP Address:** Input IP address or Domain Name of DVR (check from the **SETUP>DEVICES>Network** in DVR)
 - **Command Port:** Input Administrator’s number among port numbers set in DVR (check from the **SETUP>DEVICES>Network** in DVR). Default port number is **5920**
 - **Stream Port:** Input Video/Audio number among port numbers set in DVR (check from the **SETUP>DEVICES>Network** in DVR). Default port number is **5921**
 - **Web Port:** Input Web number among port numbers set in DVR (check from the **SETUP>DEVICES>Network** in DVR). Default port number is **80**.
 - **Login ID:** Type authorized ID of the DVR. Default ID is **admin**.
 - **Login Password:** Type correspond password of the ID. Default Password is **1111**
 - **Confirm Password:** Retype the password to confirm
 - **Pop up Display:** A user can set both video and text-in pop up or beep on corresponding channel when event occurs.

Camera

- Choose a camera name between DVR and CMS setting or both.
 - Device Camera Name: Display camera name of DVR.
 - CMS Camera Name: Display Camera name of CMS.
 - Both (Device-CMS) Camera Name: Display both as [DVR name]-[CMS name].
- If users mark the “Display to Server List”, camera name is displayed in the server list.
- Type the name of each camera in “Camera Name” item.
- Users will be able to type not only in English but also in their own languages.
- It is possible to erase all names by clicking “Clear all names”.
- Save and close the setting panel by clicking “OK”.
- If users wish to exit without saving, then click “Cancel”.
- If users mark the “Re-connect when abnormal disconnected”, CMS Pro will automatically verifies the network condition, then tries reconnecting to the site.

Alarm In

- Alarm In name setting on CMS, when Alarm In event occurs.
 - If users check “Display to Event Log” registered name shows on event log.
 - “Clear all Text” : remove all registered name

Scan Device

- This function automatically detects and DVRs/Servers which are connected under the same local router as the PC.
- Click “Scan Device”, then following will pop up. Selected desired DVR and click ‘Add Device’, and then type a password accordingly.

IP Address	Command P...	Stream Port	MAC Address
192.168.10.134	5920	5921	00:19:9c:05:dcd:1
192.168.10.247	5920	5921	00:19:9c:06:58:88
192.168.10.175	5920	5921	00:19:9c:30:38:aa
192.168.10.215	5920	5921	00:19:9c:06:5d:a5
192.168.10.43	5943	5944	00:19:9c:30:34:99
192.168.10.225	5920	5921	00:19:9c:30:38:06
192.168.10.107	59233	59244	00:19:9c:06:67:20
192.168.10.248	5920	5921	00:19:9c:06:58:8b
192.168.10.198	5920	5921	00:19:9c:06:54:6b
192.168.10.171	5920	5921	00:19:9c:06:58:9f
192.168.10.142	5920	5921	00:19:9c:06:5d:ac
192.168.10.161	5920	5921	00:19:9c:06:39:b1
192.168.10.203	5920	5921	00:19:9c:06:5d:b0
192.168.10.194	5920	5921	00:19:9c:06:53:fb
192.168.10.204	5920	5921	00:19:9c:06:3a:66
192.168.10.221	5920	5921	00:19:9c:30:38:6a
192.168.10.200	7777	7778	00:19:9c:03:88:03
192.168.10.149	5920	5921	00:19:9c:06:2a:90
192.168.10.119	5920	5921	00:19:9c:06:2a:f3
192.168.10.224	5920	5921	00:19:9c:06:2b:78

6.4.1.3 Edit Registered Site

- Select a site to adjust on local setup window and click “Edit”
- Change the setting then click “OK” to save and exit.
- Alternately, users can also edit the site by right clicking the mouse on the server name in the Server List.

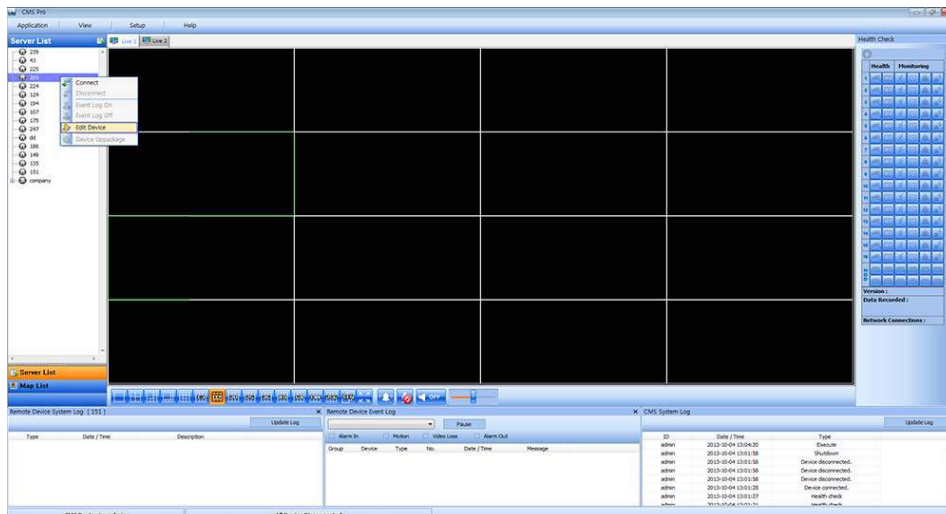

6.4.1.4 Remove Registered Site

- Select a site to delete on local setup window and click “Remove”
- The site will be removed on the local setup window.

6.4.2 Device Group Setup

- It is possible to make a group of multi-devices for user’s convenience.
 - Users are able to combine multiple devices as one group of connection for easy control.
 - Users are able to extract the cameras from registered DVRs to make own group of display.

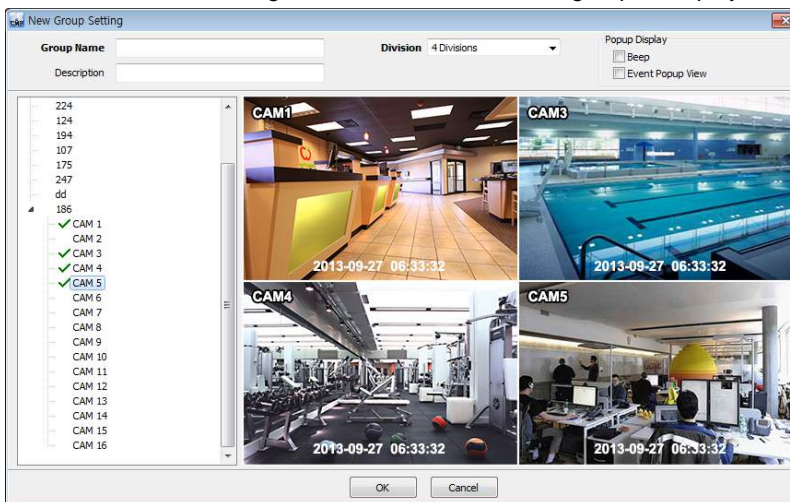

6.4.2.1 New Grouping Setting

- Click Setup – Local Setup Device – Device Group List to add/edit a group
- Click “New” to set up the Group Name, select Division (from 4 to 144), and type the Description.
- Select the site from the server list in the left-hand side of the window.
- Right mouse click and click “connect” on the site or double clicking the device will show the tree of cameras and here users can extract the channel they want.
- To add the channels into new group, drag & drop or double click on the camera.
- Users are able to continue to extract and add the channel by connecting other DVRs.
- Click “OK” to save and exit.
- Users are able to set the pop up display function.
- The newly added group will be displayed under ‘Server List’ when you go back to live screen.

6.4.2.2 Edit Group Setting

- Select a group to adjust on Group Setting window then click “Edit”
- Change the setting then click “OK” to save and exit.
- Right click on server list and select the “Edit Device”, and then following pop up window will show up. Users are able to set the “description” and Popup Display

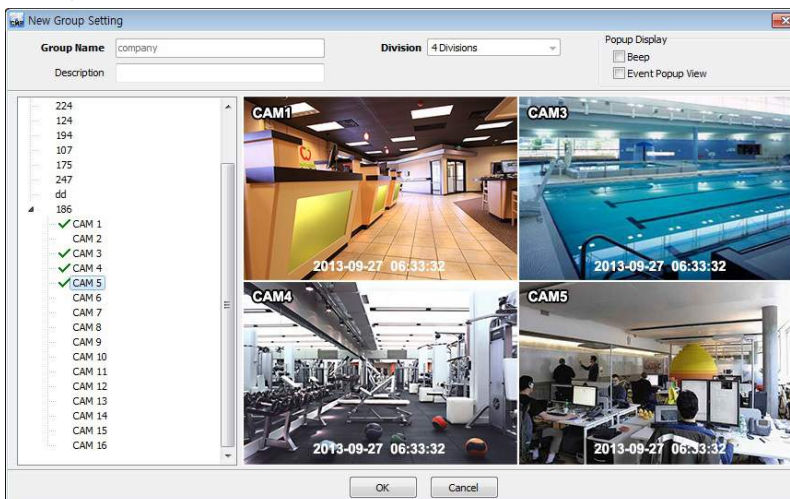

6.4.2.3 Remove Group Setting

- Select a group to delete on Group Setting window then click “remove”
- The group will be removed on the local setup window.

6.4.3 Local Setup - Environment

- This enables users to adjust the default setting of CMS Pro software for user’s convenience.

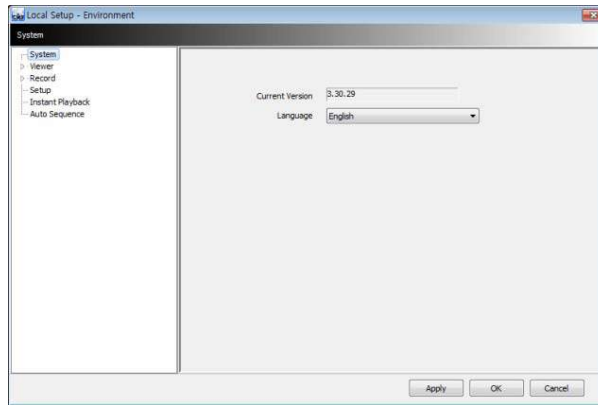

6.4.3.1 System

- Users are able to check the current version of the software.
- Users are able to select the language among English, Korean, Japanese, Russian, Turkish, Finnish, German and French.

6.4.3.2 Viewer

• Audio

- Users are able to control the Audio volume.

• Video Display

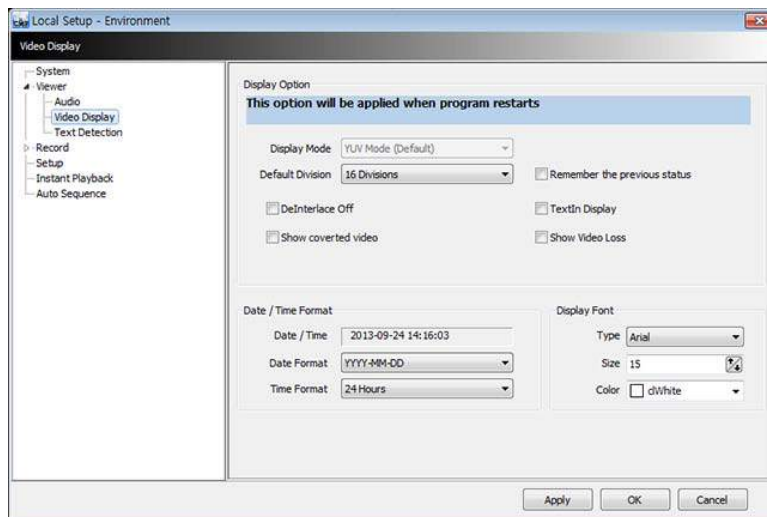

- Users can adjust and set the environment of the Display window.
- The Display option will be applied after program restarts and the contents are as below.
 - Display Mode: It shows the format of display and YUV Mode is the default and it is not adjustable.
 - Default Division: Users can select the number of division of display channels when the program initially displays the screen. (from 1 to 144 division)
 - Users are able to save division of display by marking the “Remember the pervious state” check box.
 - Deinterlace Off: This function changes playback display into Progressive Scan or Interlace Scan. Uncheck () Deinterlace Off, then box will display as the Progressive Scan and shows the better picture quality.
 - Show converted video: if this box is checked, covert cameras from DVR will show up.
 - Text-In display: Text data will be overlaid on live and playback.
 - Show Video Loss: Popup window will display, if video loss occurs on the connected DVR.

NOTE

If users check "Show covert video" box, this setting will be applied to playback as well.

NOTE

All changes made above will be applied after program restarts.

- Date / Time format: Users can adjust and set the mode of date / time display in accordance with the location.
 - Date/Time: show current time.
 - Date Format: select the date format among YYYY-MM-DD/MM-DD-YYYY/DD-MM-YYYY.
 - Time Format: select the time format between 24Hours/ 12 Hours AM/PM.
- Display Font: Users can change the font of the name and display time of each channel.
 - Type: select the type of font between Arial and Courier.
 - Size: select the size of the font from 10 to 20 and the default is 15.
 - Color: select the color among 16 different colors.

• Text Detection

When the software can pop-up a notice windows when a certain text is detected from a DVR that has an attached Text/POS device.

- Device: choose a device
- Message: add message like 'VOID'. (When added message – 'VOID' – occurs from DVR, window will pop up.)

6.4.3.3 Record**• Backup**

Users can customize the storage path of the image file of Screenshot or Zoom in Screenshot by typing the path or clicking the folder icon.

- Save Directory (Screenshot): Select the save directory by designating the folder in the PC and save format between bmp and jpg.
- Save Directory (Zoom in Screenshot): Select the save directory by designating the folder in the PC and save format between bmp and jpg.

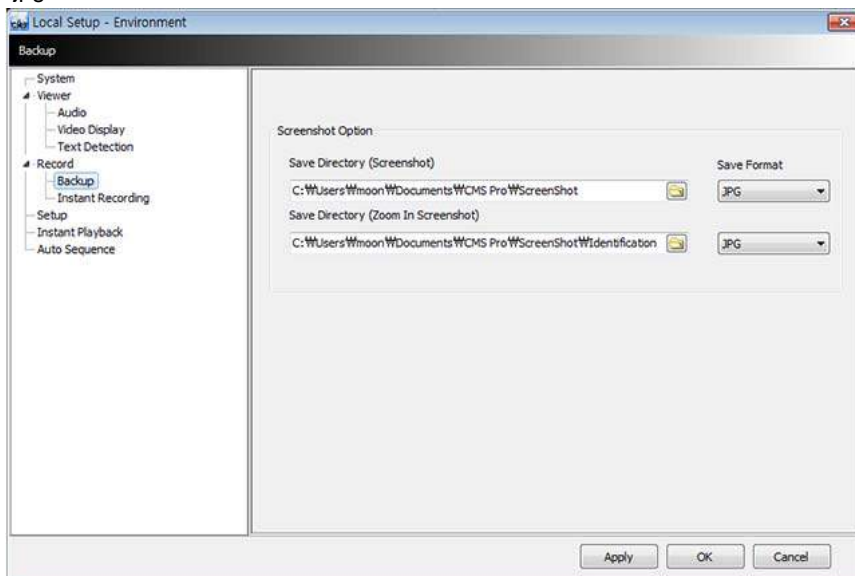

- Instant Recording

Users can customize the storage path of the instant recording file by selecting HDD installed in PC.

- Select Drive: Select PC's HDD where instant recording file should be saved from the drop down menu and click "Add". It will show Drive type, Free Space and Total Space of selected HDD.
- Storage List: Added HDDs can be prioritized or deleted. Use Up and Down arrow to prioritize and "Delete" to remove HDD from the list.

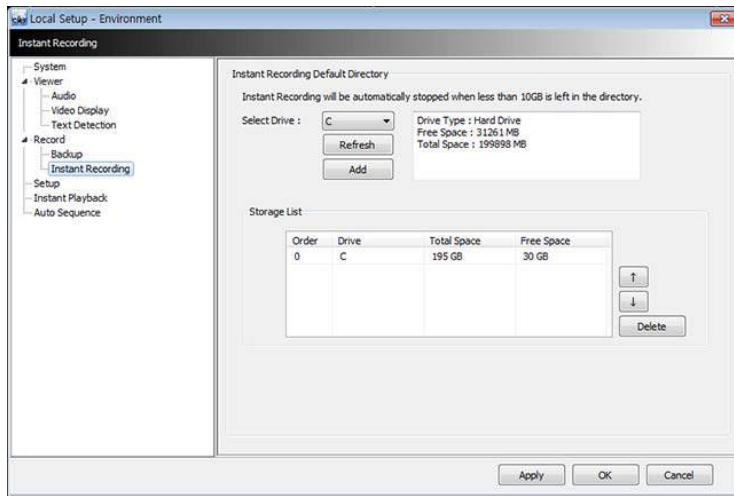

NOTE

Instant Recording will be automatically stopped when less than 10GB is left in the directory.

NOTE

Please refer to Chapter 6.7.2.9 Instant Recording.

6.4.3.4 Setup

- Users may save the current CMS Pro configuration data as a file and import it later to the same PC or another one.
- Select Save Directory: Users can select the save directory of setup data or log data by designating the folder in the PC or other storage device and the change of the directory will be applied only after clicking "OK" button and exit.
- Select Data: Select data which users would like to save in the storage devices.
- Default setup: Initialize the setup to factory default. Click "OK" to exit the program.

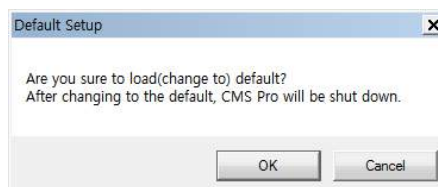
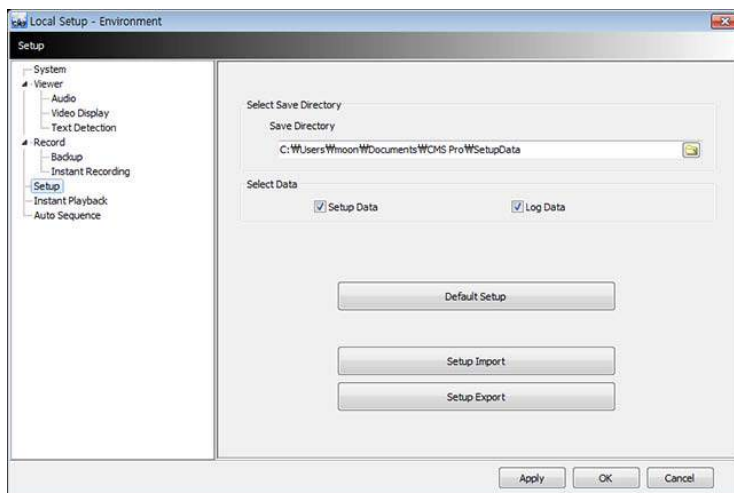

- Setup Import: Copy the Menu setup stored in USB memory stick (or PC HDD) into DVR. Please plug in the memory stick and then click (←) Import.
- Setup Export: Store the Menu setup of DVR in USB memory stick (or PC HDD). Please plug in the memory stick and then click (→) Export.
- Apply: Click the “Apply” button to apply the settings.

6.4.3.5 Instant Playback

- Instant Playback: Users are able to see the recorded data easily by using instant playback function.
- Set the time from which the recorded data is displayed.
- Instant Playback starts from the last preset time. (1, 3, 5, 10, 15, 30Min, 1, 3Hour, Default is 3Min)
- For example, if 5 Min is set as a playback period, then users are able to see the last 5 minute’s data from the current time.
- To activate the Instant Playback, just right click on a live screen and select ‘Instant Playback’.

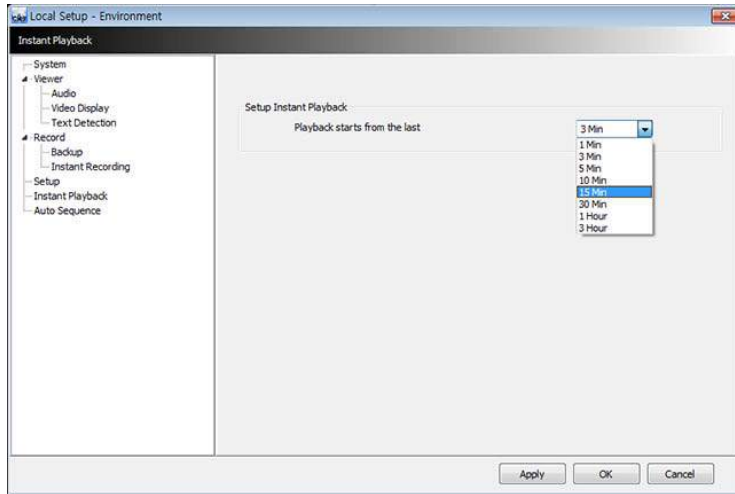

6.4.3.6 Auto Sequence

- Auto Sequence: Users are able to switching the camera view and setup the dwelling time.
- Set the dwelling time by clicking the  to increase and decrease duration. (3 to 60 seconds).

6.4.4 Local Setup - Account

- When more than 2 users need to access CMS Pro, multiple User Accounts and its authorization can be set in this menu.
- This setup is only permitted to Admin account holder.

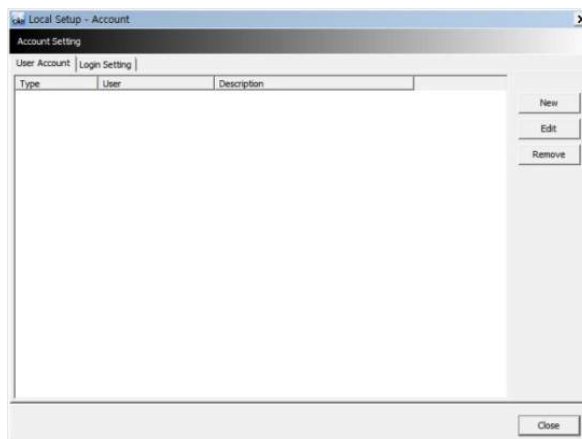

6.4.4.1 Add User Account

- Click “New” button and the following will display.

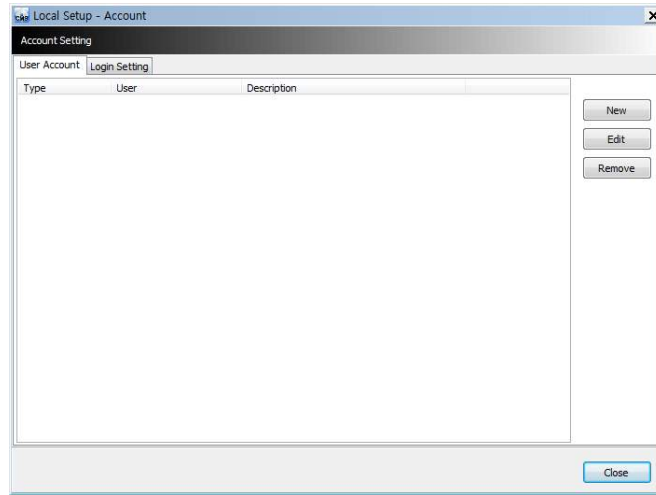

- Type: Select one of the two types of user account, Manager and User from the drop-down menu.
 - While Manager Account allows all of the authorization to be controlled, User Account is permitted to set only Search, PTZ control, and E-map functions.
- Create a User name and Password and then type Description of the account.
- Mark the authorization check boxes () to allow.
 - It is possible to give an authorization selectively to the individual user account.
 - “Check All” grants all the authorizations and “Uncheck All” deprives all the authorizations.
- Click “OK” to save and exit.

6.4.4.2 Edit User Account

- Users are able to adjust its Authorization and Password from EDIT button.
- All the procedures are same as Add User Account.

6.4.4.3 Remove User Account

- Users are able to remove the existing account.
- Select an account to delete then click “REMOVE” button.

6.4.4.4 Login Setting

- This function protects any activities of all Manager/User accounts by asking ID and Password prior to the fulfillments.
- Select the activities from the list () and click “Apply” to save.

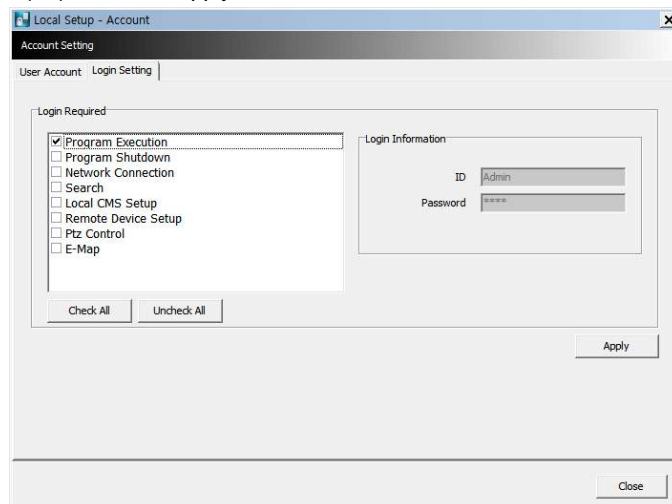

6.4.5 Local Setup – E-map

- Users are able to create various E-maps and it enables monitoring both Live and Playback screen.

6.4.5.1 Registering a New E-map



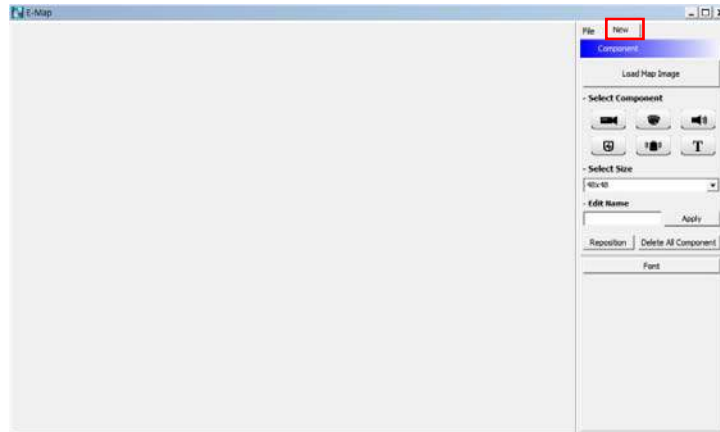

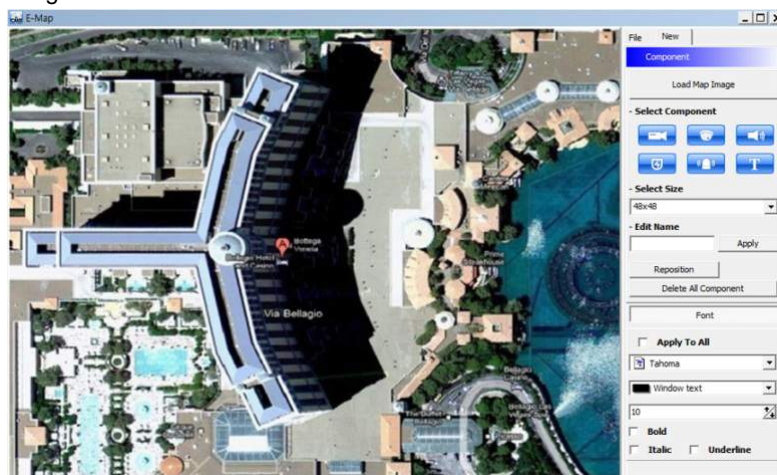

- Click “New” Tab to set up the E-Map.









- In order to load an image of the map, click “Load Map Image” that users would like to use as an E-Map.
- Users should select the image format between BMP and JPG.



- Place the icon of cameras, audios and alarms on the map. Each icon’s detail is as below.

-  Box Camera: Generally indicates as Outdoor camera.
-  Dome Camera: Generally indicates as Indoor camera.
-  Alarm/Sensor: The icon is blinking on when the alarm in is activated.
-  Audio: Users can hear the audio in the site by clicking the icon after setting the E-map.
-  Relay: If users click the icon, the light is on the icon and the attached device on Relay such as siren and buzzer will be activated in the site.
-  Insert text box: Users are able to put description in the map using the Text Box.

- Select component

-       Click the icon you want (then the icon turns to orange color) and click again on the place you’d like to locate on the loaded image.
- Users can rotate the icon to the direction that they want and move to other places by dragging.



- Select Size: Size of the icon varies from 24*24, 32*32 to 48*48.
- Edit Name: Type the name of the icon and click the "Apply" to change the name.
- Reposition: The icons which are set up on the map can be repositioned into the right place even if the map size is changed (enlarged/reduced).
- Delete All Components: By clicking this button, users can delete all the components in the map at once.
- Font: Change the font of the text of the icon.
 - Click "font", then submenu will display.
 - Users can select the font style, color, size, and other effects.
 - Check "Apply to All" to apply the change to all the components.

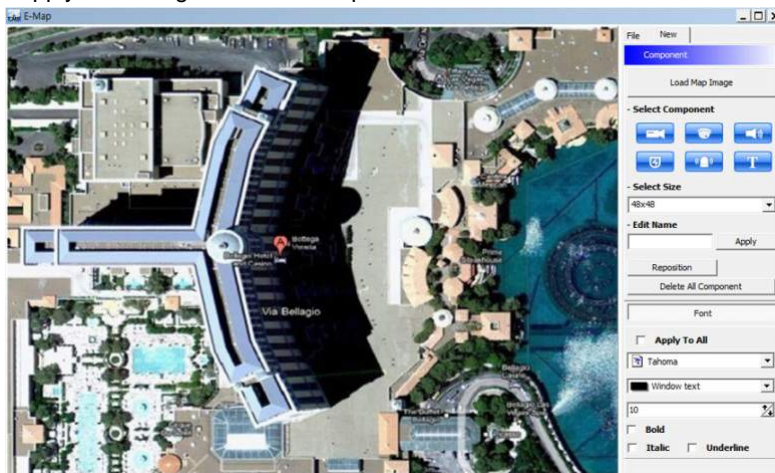

- Click "File" Tab to continue to set up the E-map.
- Type a name of E-map when you finish map setting in "New" menu.
- Click "new" to add a new location in Location list. If the other location is already saved, then select the location from the list.
- Select type among Outdoor, Floor, and Room.
 - Users can set up the hierarchical E-map, if necessary.
 - For example, after setting up the floor map, room maps are added under the floor map.
- DVR Name: Select the specific DVR from the list to connect E-map.
- Users are able to check the E-map and its hierarchical structure from the "Registered E-map list".
 - Here, users are able to load the map, delete the map and show map viewer by clicking mouse right button on the map list.

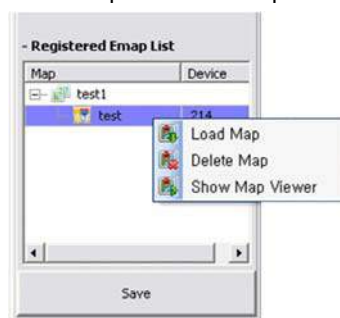

- Click “Save” to save and exit.



6.4.6 Remote Device Setup

- Select a device to enter device’s configuration and Click “OK” then the web browser will pop up as below.

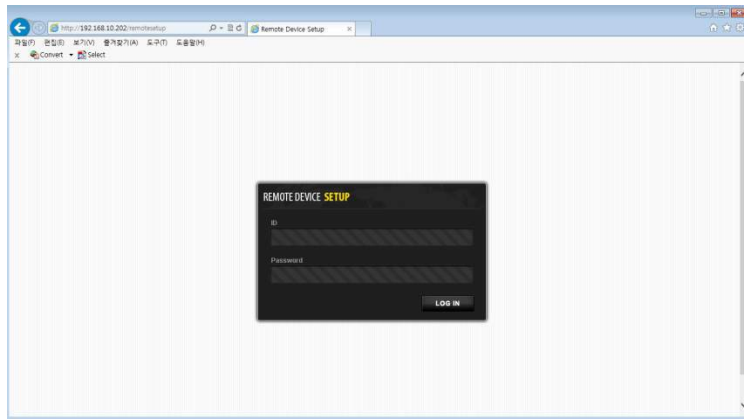
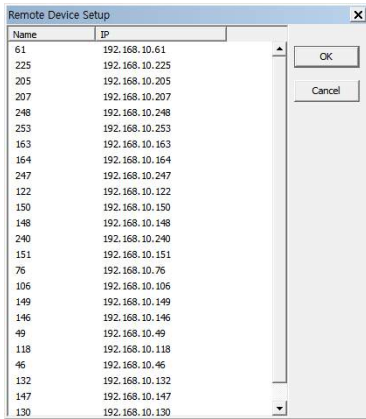

- Enter ID and Password to open Remote Device Setup page and following page will display.
- Web server port (default, 80) should be port forwarded to use remote device configurations.

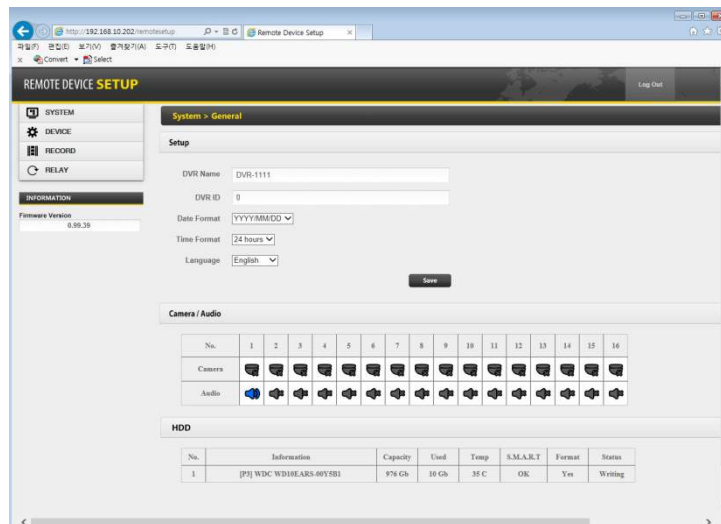

NOTE

Remote Device Setup menu shows the same menu interface as the DVR’s local menu. Please refer to **Chapter 4. Setup** for detailed information.

6.4.6.1 System

- Refer to **4.2 System** for more detail.

6.4.6.2 Device

- Refer to **4.3 Device** for more detail.

6.4.6.3 Record

- Refer to **4.4 Record** for more detail.

6.4.6.4 Relay

- Refer to **4.5 Relay** for more detail.

NOTE

Some settings cannot be modified remotely.

NOTE

The changed password cannot be restored. Please keep and remember not to lose!

6.4.7 Change Password

- Users are able to change the using password of the ID, when they open the software. This is not related to any DVR's login password.
 - Password: input the current password.
 - New Password: input the new password.
 - Confirm Password: confirm the new password.



NOTE

User "ID" cannot be modified.

6.4.8 Help

6.4.8.1 About

- The version of CMS Pro can be checked here.

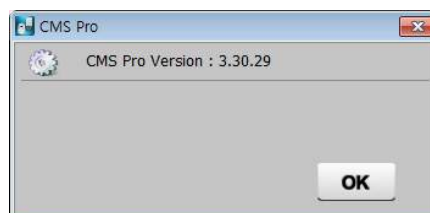

6.5 View

- The viewer of this program is composed with 5 types of different panes.
 - Server List, Remote Device System Log, Remote Device Event Log, CMS System Log and Health Check.

6.5.1 Server List

- When the device is registered, then it is displayed on the Server List.
- If uncheck “Visible” in the server list menu, then the list will not be shown.
- Check “Left” or “Right” to move the list to left or right side of the screen.

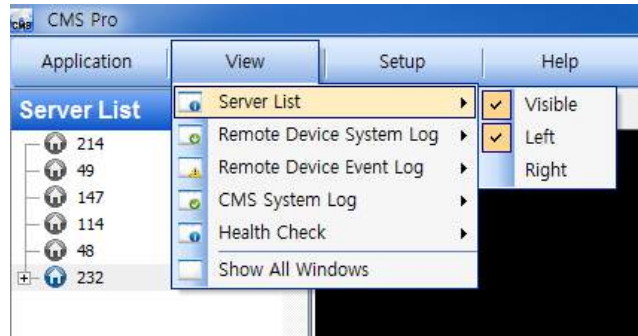

6.5.2 Remote Device System Log

- User can check the system log of the device in this menu.
- Type, Date/Time/Description can be checked.
- The contents in the parenthesis show the name of the device. Ex) [Demo]
- Check “Visible” in the Remote Device System Log menu to see the menu or uncheck “Visible” in order not to see the menu.
- Click the “Update Log” button to update the log.

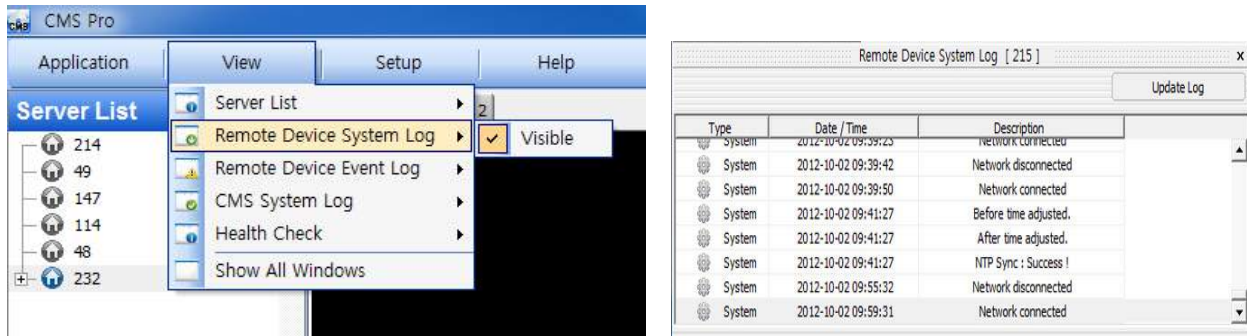

6.5.3 Remote Device Event Log

- User can check the event log of the device in this menu.
- Check “Visible” in the Remote Device Event Log menu to see the menu or uncheck “Visible” in order not to see the menu.

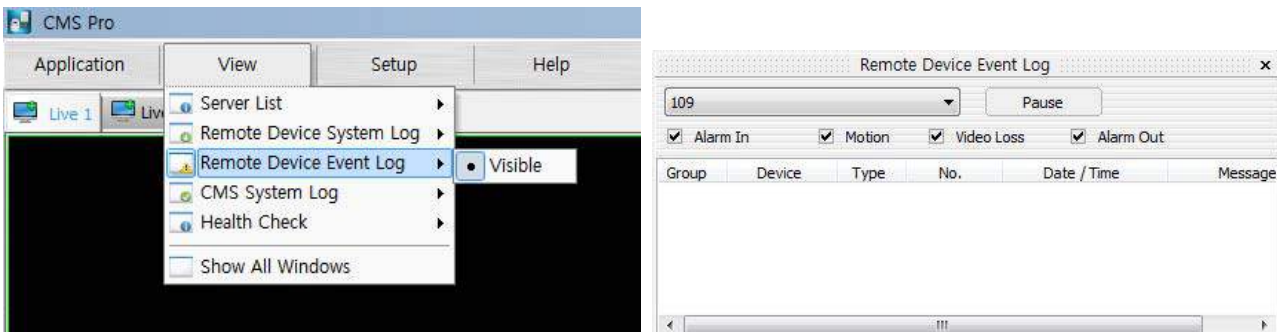

- Users can select the registered device from the drop down box menu.
- Alarm In / Motion / Video Loss / Alarm Out can be selected separately as Event. (More than 2 events can be selected at the same time.)
- And by clicking “Event log On/Off” after right mouse click on the device in the server list, users can check/uncheck all the events at once.
- When the event operates, the event log will show the information of the event in the list.
- If click the pause button in the menu, then event log will be stopped.
- Click the resume button to resume the system event log. (The log data will be lost during the pause.)

NOTE

The Remote Device Event Log is on when the “pause” is shown while the log is stopped when the “resume” is shown in the menu.

- Double click the detected “Alarm In” or “Motion” event in the remote device event log to check the video of the event.
- Click the “Refresh” button to refresh the data.
- Click the right mouse button on the registered device to on/off Event Log in the Server List.
- A user selects “Event Log Off”; all event logs will be unchecked on Remote Device Event Log panel.

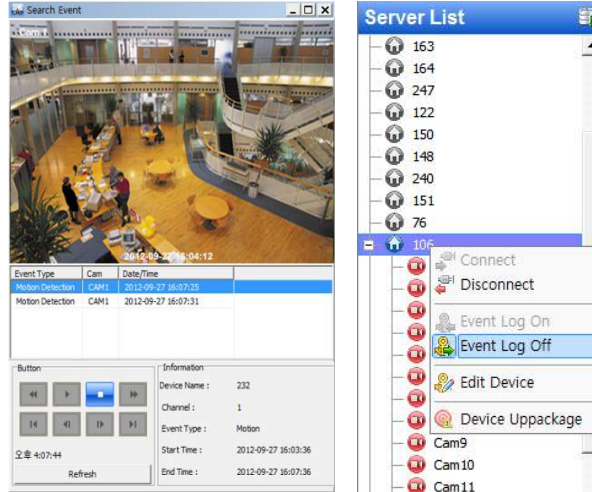

6.5.4 CMS System Log



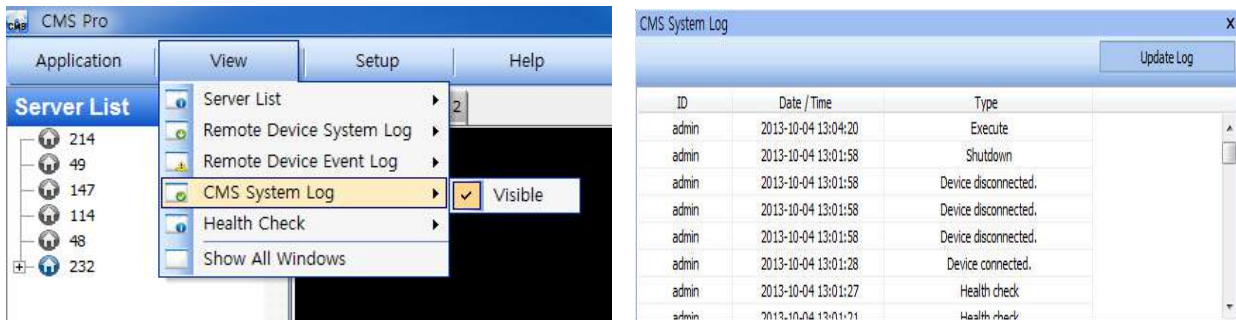





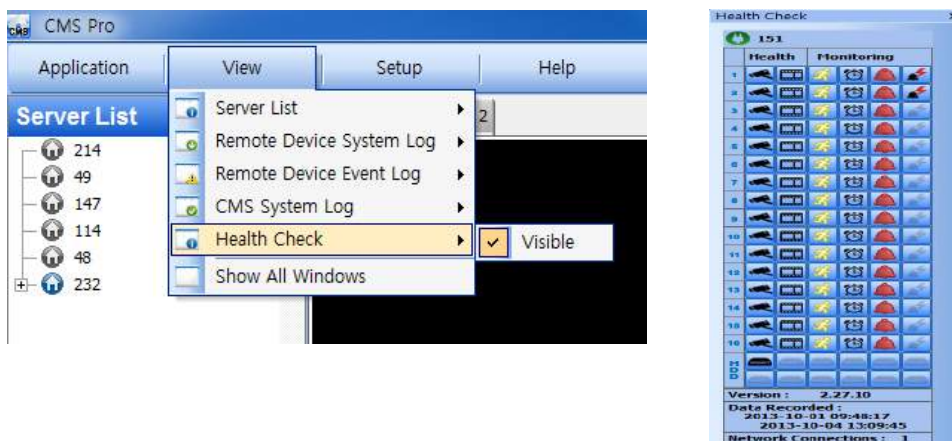













- This is the log menu where users can check the log information of the CMS program.
- Check “Visible” in the CMS System Log menu to see the menu or uncheck “Visible” in order not to see the menu.
- Click the “Update Log” button to update the log.
- User can classify the Manager and User by checking the ID and get the information of connect/disconnect and shutdown of the user.



6.5.5 Health Check

- This is the menu where users can easily check the overall status of a device.



- Check “Visible” in the Health Check to see the menu or uncheck “Visible” in order not to see the menu.
- Left mouse click on the device in the server list to see the information of health check.
- HDD Status
 -  HDD is not connected and cannot be added.
 -  HDD is connected.
 -  HDD is not connected currently but can be added.
 -  An error occurred in HDD.
- Camera Status
 -  Camera is in covert mode.
 -  Camera is connected.
 -  Camera is not connected currently but can be added.
 -  Camera is not connected and cannot be added.
- Recording Data Status
 -  The channel is not being recorded because it's not supported.
 -  The channel is being recorded.
 -  The channel is not being recorded currently but can be recorded later.
- Motion Status
 -  Motion is not activated and supported.
 -  Motion is being activated.
 -  Motion is not activated but can be activated later.
- Alarm In Status
 -  Alarm In is not activated and cannot be added.
 -  Alarm In is being activated.
 -  Alarm In is not activated currently but can be added later.
- Alarm Out Status
 -  Alarm Out is not activated and cannot be added.
 -  Alarm Out is being activated.
 -  Alarm Out is not being activated but can be added later.
- Relay Out Status
 -  Relay Out is not activated and cannot be added.
 -  Relay Out is being activated.
 -  Relay Out is not being activated but can be added later.

6.5.6 Show All Windows

- This function will make visible all the invisible window panes.

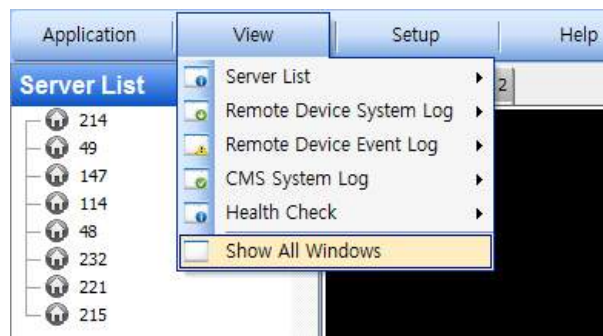

6.6 Application

6.6.1 Search

- There are five different types of search menu; Timebar, Event, POS/ATM, Thumbnail and Smart Search
- The detailed information and directions is described in **chapter 6.8**.

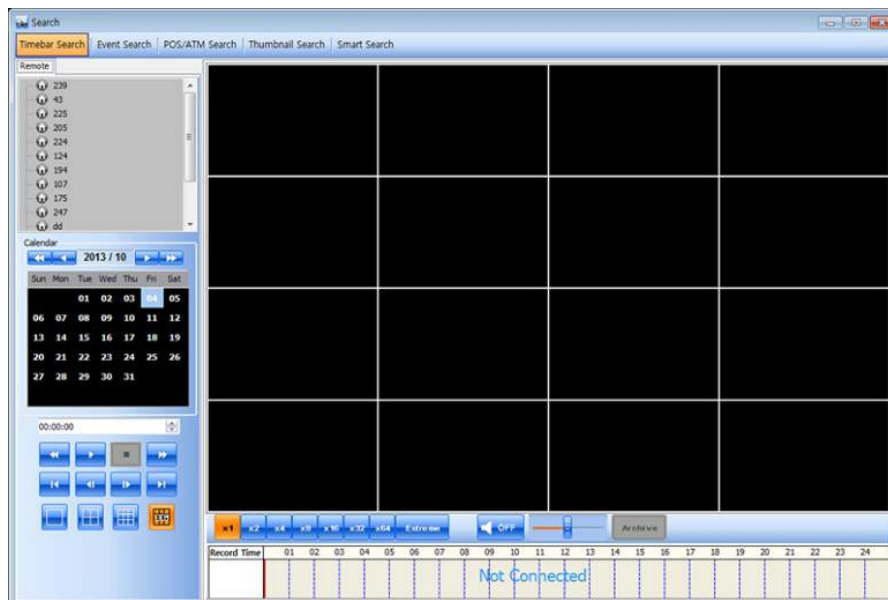

6.6.2 Exit

- If users wish to exit the program, then click the "Exit" in the Application menu.

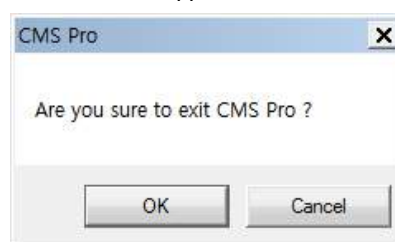

6.7 Live (Live Video Monitoring System)

6.7.1 Overview

- This program is to display live video from multiple channels in customized screen format.
- The program is based on user friendly interface. Users may configure the entire program and open or close the panes and screens in the program.
- The information of the device can be checked and monitored in real time.
- The overall information of recording/live view can be checked.
- 'Login Display' pane is to display the current user ID, authority group, data and time information.
- Dual, Triple monitor can be available and the quadruple monitor can be available by using splitter.
- Two live panes. 256 channels for each pane.

6.7.2 Live Monitor Menu

- The following functions are operated when the right mouse button is clicked on the screen.



6.7.2.1 Full Screen On

- Click "Full Screen On" to make selected channel into a full screen.
- Click "Full Screen Off" to exit the full screen.



6.7.2.2 Auto Sequence

- Users are able to set the auto sequence.
- When users set the "Auto Sequence" display mode, screen will change to 1 channel display mode and channel will be changed by user's setup. For more information Please refer **chapter 6.4.3.6**.

6.7.2.3 Instant Playback

- Instant playback is available in both Live1 and Live2 pane, but screen capture is available in either live1 or live2.

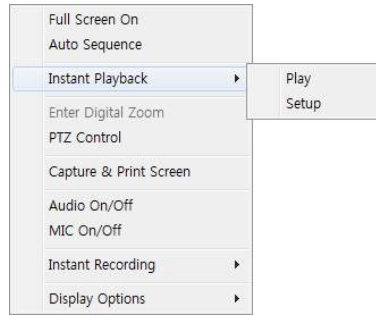

- After right mouse click, move the mouse cursor to “Instant Playback”. Then, play and setup menu will display.
 - Play: The recorded video of the pre-setup time will be displayed in the playback viewer.
 - Setup: The time of instant playback can be setup in this menu, from 1minute to 3hours. (1Min, 3Min, 5Min, 10Min, 15Min, 30Min, 1Hour, 3Hour. The default time is 3Min.)

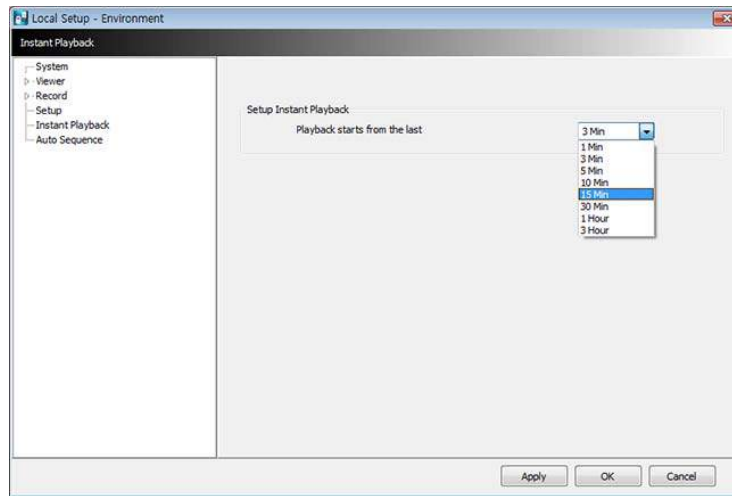

NOTE

Users can also set up the Instant playback in the menu, “Local Setup – Environment”.

- The image capture is supported in the instant playback viewer by clicking right mouse button on “Capture Image.”

NOTE

For more detailed information of captured image, please refer to the Chapter 6.7.2.6 “Screen capture & Image”.

6.7.2.4 Digital Zoom

- To use digital Zoom, please make the display as 1CH.
- Right click on the mouse and select Enter Digital Zoom.

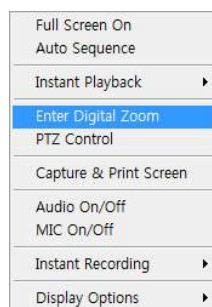

- To zoom in and out, please use the display function at the corner of the channel Display or click and drag the area wish to zoom in.
- Zoom area can be moved by dragging the position from the corner box.

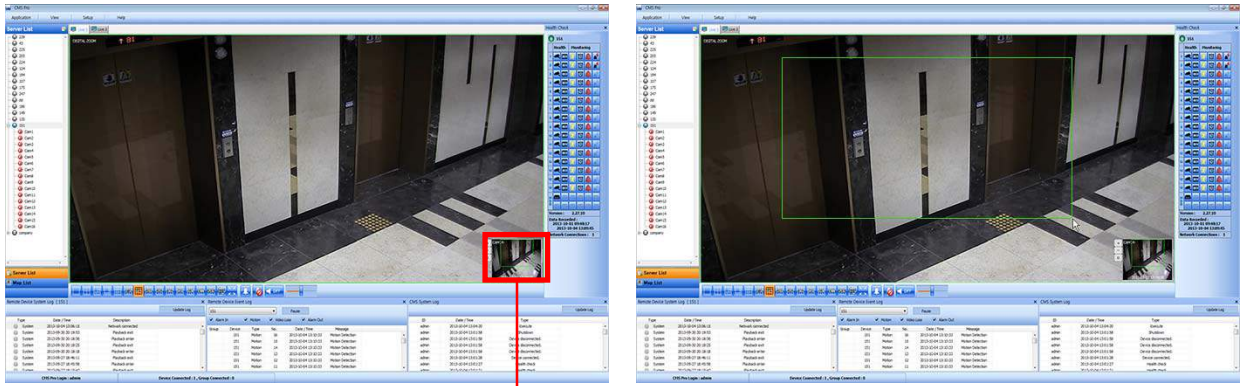

Zoom in / out function



Zoom In



Zoom Out



Zoom Area: The Screen will revert to x4 digital zoom screen.



Zoom Area

NOTE

Digital Zoom function can be only used when the display is on 1Ch mode.



The digital zoom function is able to zooming approximately x32.

6.7.2.5 PTZ Control

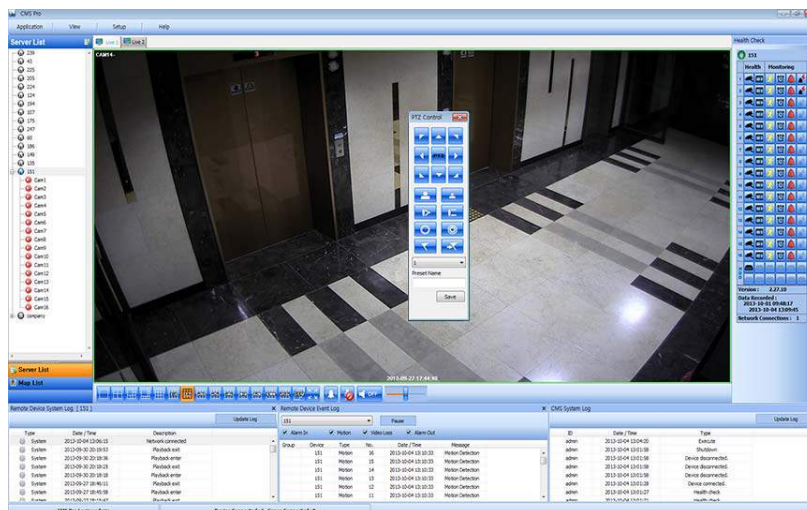
- After right mouse click on the channel that PTZ camera is connected, select "PTZ control".
- Users can designate the certain position and set the name by using "Preset" function.
- Up to 255 presets can be designated.



- Zoom

-  Zoom in
-  Zoom out



- Focus

-  Near Focus
-  Far Focus

- Iris

-  Iris Open
-  Iris Close

- Preset

-  Set Preset
-  Go to Preset



- Drop down menu: Select a preset number which is set in the camera.
- Preset Name: Save the selected preset name.

6.7.2.6 Screen Capture & Print

- After right mouse click, select “Capture & Print Screen”
- The brightness, contrast and saturation can be adjusted to store and can be printed directly.

NOTE

Image adjustment is only possible on the last captured image.

- Users are able to save the captured image by clicking “Save as Image”.
- Create a name of captured image and select the image type as BMP or JPG
- Users are able to choose the folder where they wish to store the image.

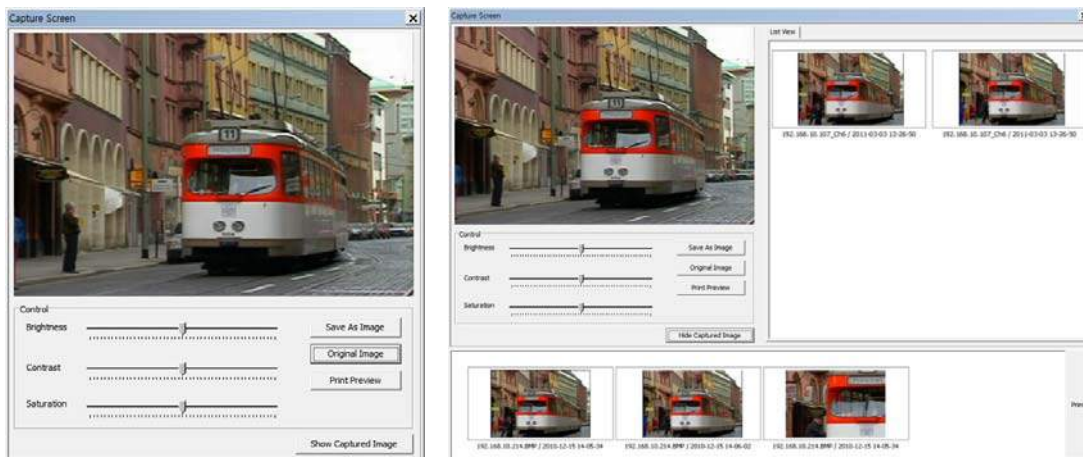



- Click “Show Captured Image” to show the captured images.
- Users can even **recapture** the part of the captured image by dragging the place users want.
- Click “Print” button to print all the captured images at once.
- If users want to print the image one by one, then click the “Print Preview” button.
 - Users can type the title in the text box on the top
 - Add Text: Users can add the description in the text box on the bottom.
 - Delete Text: Delete the last written text at once.
 - Delete all: Delete the all the text in the captured image.

- Click “Hide Captured Image” to hide the captured images.



6.7.2.7 Audio On/Off

- Right click and select Audio On/Off to turn on/off audio from the channel.
- Audio On/Off function is applied to only one channel out of all connected channels.

– Once audio is on  will be changed to show connected audio channel. 

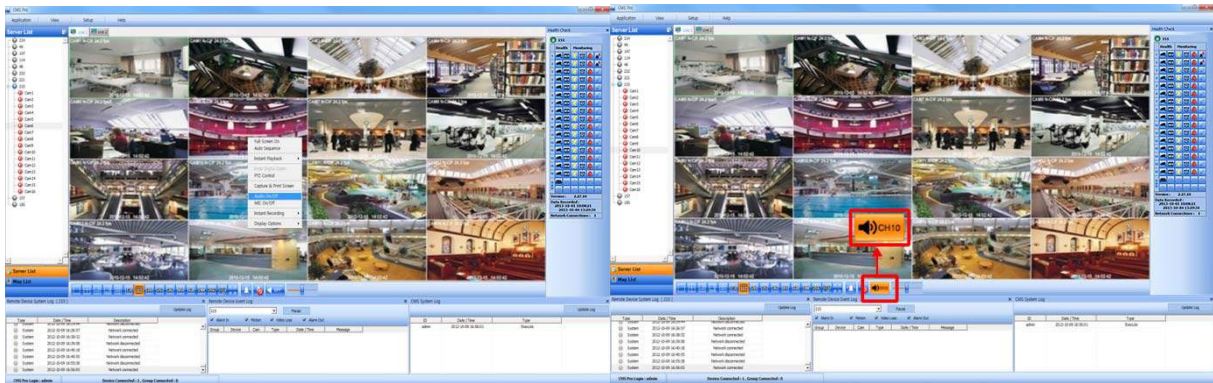

6.7.2.8 MIC On/Off

- Click right mouse button to turn on/off microphone of PC.
- Users can deliver the audio through the speaker connected to DVR by sending the audio from PC where CMS Pro is activated.

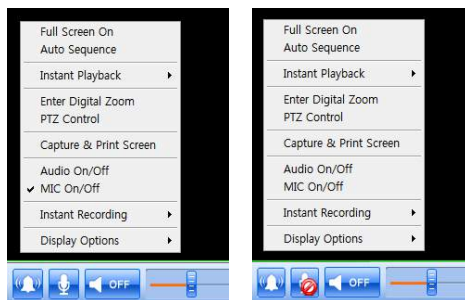

6.7.2.9 Instant Recording

- Click right mouse button to activate the Instant Recording.
- In the Instant Recording, there are three choices of start recording, setup and open folder.
- Click Start Recording to record the particular channel that user wants.



- If a user wants to have password for the archiving file, please click 'Use Password' and type the password that users want to use.



- If users click 'OK', it will start recording of that specific channel.
- When users want to view the archived file, please choose "Open Folder"



- It will open the saved directory of the file.
- When users double click the created file, password window will pop –up.
- Please type the previous password that users entered in Password setup

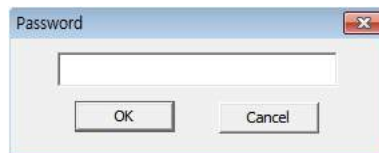

- When Users want to "stop recording", click right mouse again and select Instant Recording and choose "stop recording".
- Choose "Setup" in the Instant Recording to set up the recording duration and default directory.
- In the recording duration, users can setup the hours and minutes by clicking the "upside down arrows" 

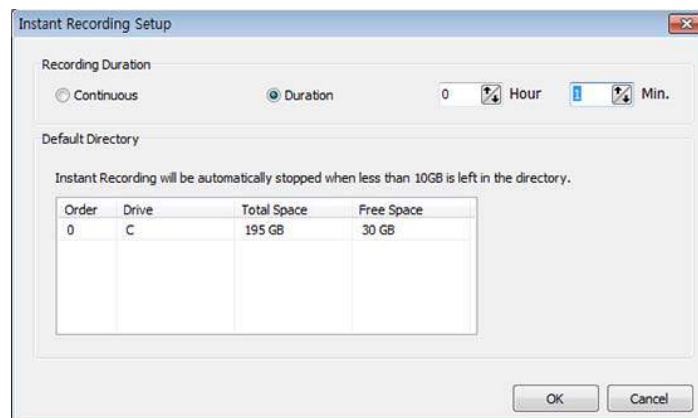

- "Open folder" will allow a user to select the recorded files and play them.

6.7.2.10 Display Option

- Users can set up the display of camera name and time in “Display Option”.
- After right mouse click, check the “Show Camera Name” to display the camera name or uncheck the menu to hide it.
- After right mouse click, check the “Show Time” to display time or uncheck the menu to hide it.

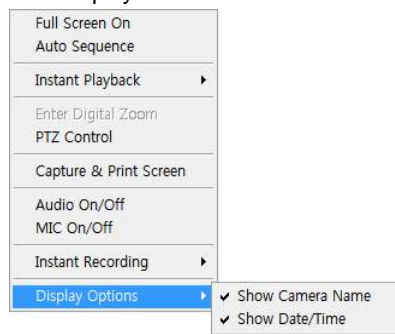

6.7.3 Screen Layout Control

- Every menu pane can be relocated by drag and drop.



6.7.4 Change Division Display

- From a single full screen to 256 channels, various combination of channel display is provided by clicking the icon at the bottom of the screen.

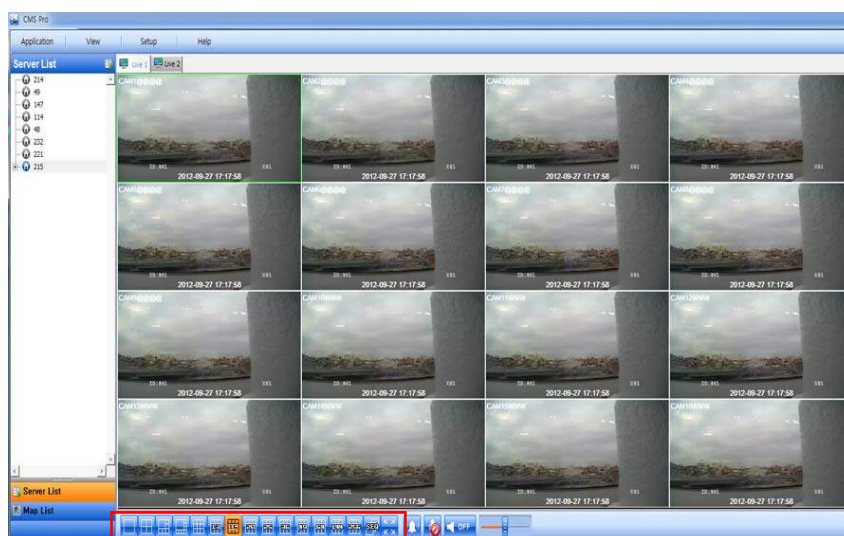

6.7.5 Sequencing

-  Click the icon to switch the channel according to setup made in auto sequence in Local setup – Environment.
- It is only supported one channel.

6.7.6 Audio Volume Control

- Users can control the audio volume using the bar controller at the bottom of the screen.

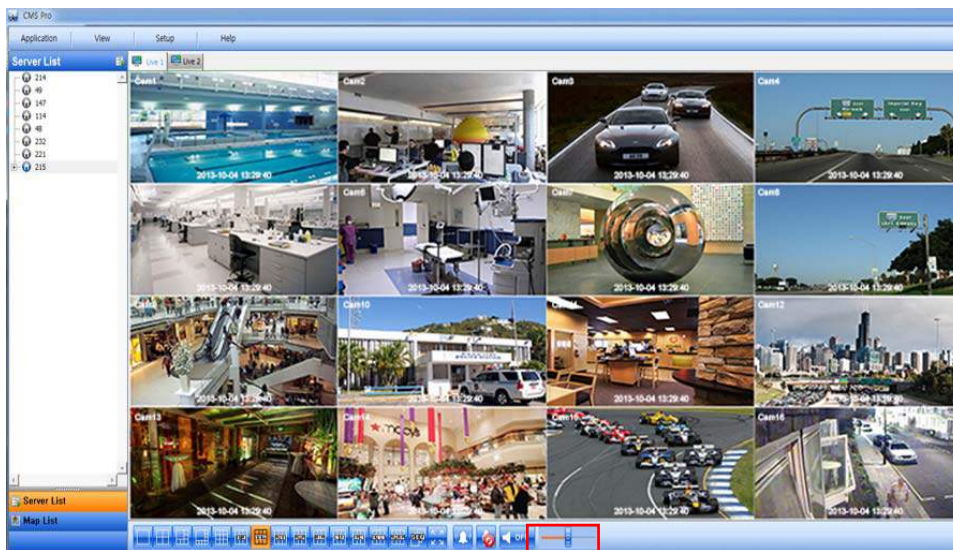

6.8 Search

6.8.1 Overview

- 5 ways of Search are available. (Time Bar Search, Event Search, POS/ATM (keyword) Search, Thumbnail Search, and Smart Search).

NOTE

Search window cannot be closed during playback, also cannot be changed window size. Please close the window after stop. Playback more than 2 channels at the same time is available only in time bar search.

6.8.2 Time Bar Search

- Open a search window by clicking the “search” in the application menu.
- Click the “connect” after right mouse clicking on the device list.
- Once it is connected to the program, date, month and year of the recorded data is highlighted in the calendar.
- The text box in the left-bottom side of the window shows the time of playback video.
- The recorded data of a day is displayed as a colored bar on the time line at the bottom.
- Users can easily search the recorded data by clicking on the time in the time bar.

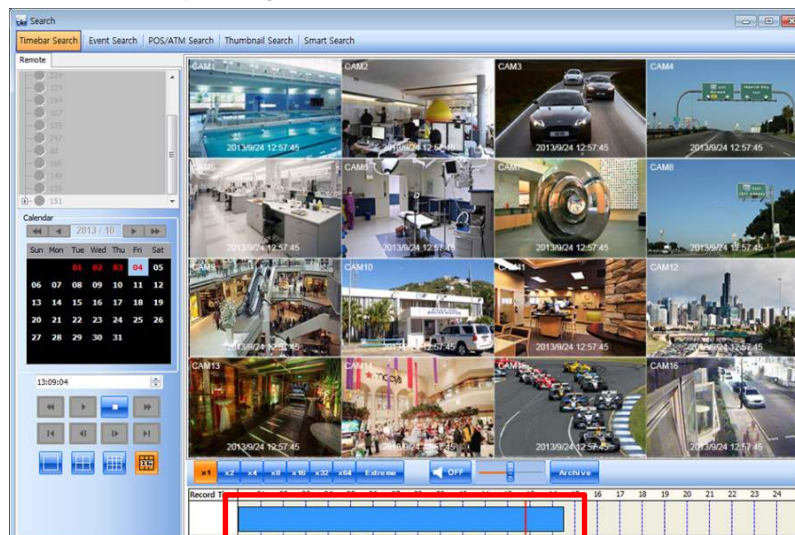

- Users can change the speed of rewind and fast forward from x1 to Extreme. The actual speed may be limited by DVR's network uploading bandwidth.

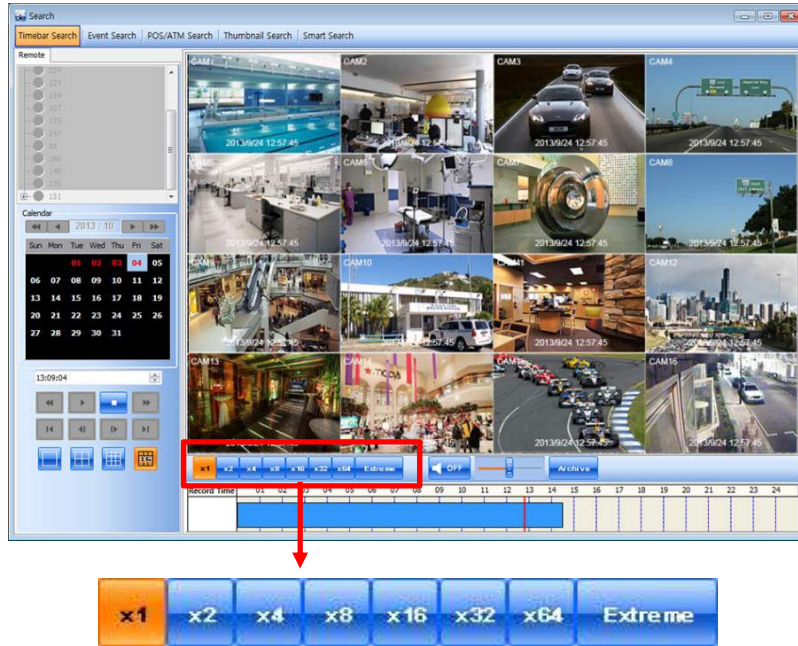

- Users can use Right click to access Audio On/Off, Digital Zoom and Capture and Print Screen.
 - Audio On/Off: A user can enable audio function. If Audio is connected Audio Status will change.
 - Enter Digital Zoom: A user can use Digital zoom. Please refer **6.7.2.4 Digital Zoom**.
 - Capture and Print Screen: A user can capture image. Please refer **6.7.2.6 Screen Capture and Image**.

NOTE

Audio and Digital Zoom are supported only in 1CH display mode.

- In the playback menu, users are able to search the data from the beginning of the day or from the cursor position.
- Or just simply click on the time line users want, and then click “▶” button on the left.
- Click “Archive” button to save certain channels as a video file.



- Select a start time, end time, file name, the location of the file, password and the cameras to store.
- Click “Start EXE Backup” to start archiving.

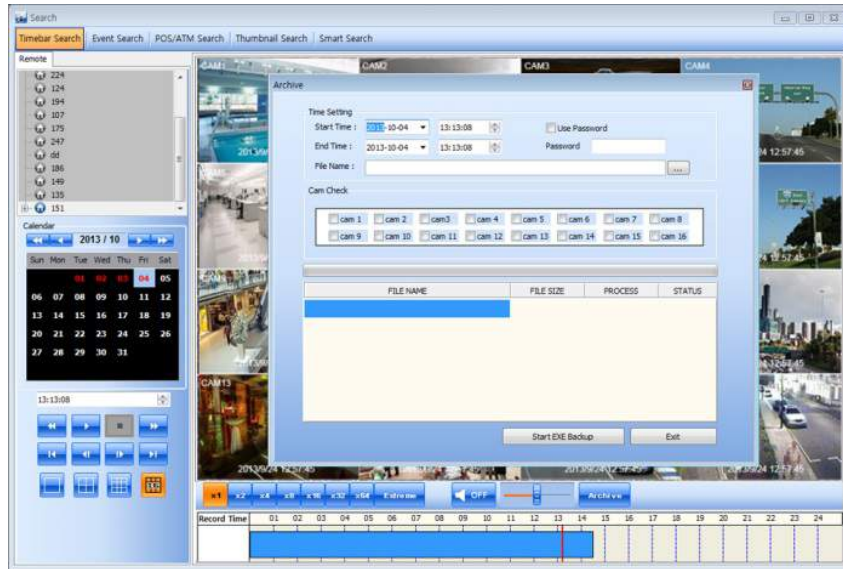

NOTE

Archiving function can be initiated only in time bar search.

6.8.3 Event Search

- Click the “connect” after right mouse clicking on the device and select the “Event Search”.
- Check the event type which users wish to search among “Emergency,” “Alarm” and “Motion”.
(Users can select more than 2 event types at the same time)
- Select a camera to search. (Only 1 camera can be selected in event search.)
- Specify the start time and end time in Date/Time setting and click “Search” button.

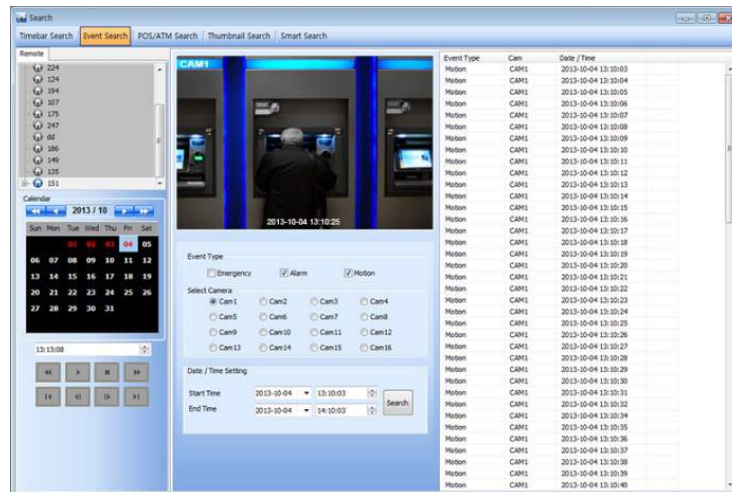

- To check the event that is detected on the right side of the search window, double click the event that users want.

6.8.4 POS/ATM Search

- Click the “connect” after right mouse clicking on the device and select the “POS/ATM Search”.
- Type the actual keyword that users want to find in the “POS / ATM” text box.
- Select a camera to search. (Only 1 camera can be selected in this search.)
- Specify the start time and end time in Date/Time setting and click “Search” button.
- The detected text will be displayed in the right side of the search window.
- Double click or click on the event (Text In) and click the play button “▶” to check the playback.

- Display Position – Users are able to select the text display option of the playback.
 - Text Window: Only text will be displayed in the top right side of the search window during the playback.
 - Overlay: The text will be overlaid on the playback video.
 - Both: The text will be overlaid on the video and the text window as well.
 - Hide All: The text will not be displayed in both video and the text window.
- To check the event that is detected on the right side of the search window, double click the event that users want.

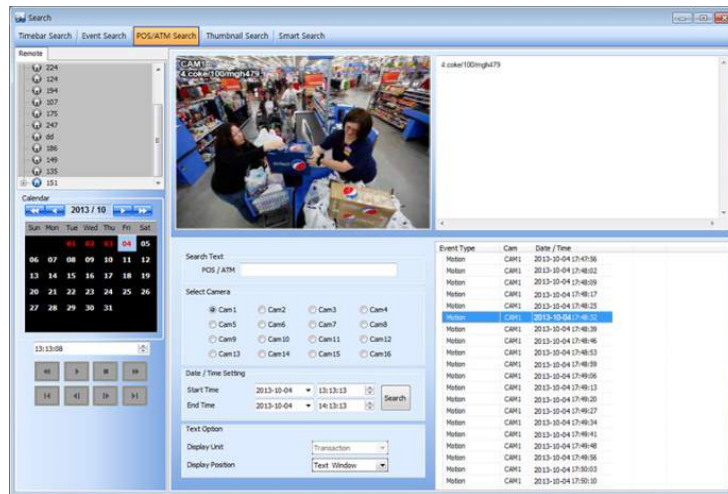

6.8.5 Thumbnail Search

- Click the “connect” after right mouse clicking on the device and select the “Thumbnail Search”.
- This search function provides the users with the snapshots of the recorded video by user’s definition.
- Users are able to choose the duration of the playback in “Thumbnail Duration” from 1Min to 60Min. (1, 3, 5, 10, 20, 30 and 60Min)
- The number of “Max Capture Count” can be setup as 32, 64, 128 and 256.
- Specify the start time and end time in Date/Time setting and click “Search” button.
- Double click the listed snapshot images to check and play the video.
- Click “Stop Search” to stop the search and check the video to the stop time.
- The video will be displayed in the “video display” panel at the bottom of the search window.
- Users can move the panel around the screen and adjust the size of the panel.

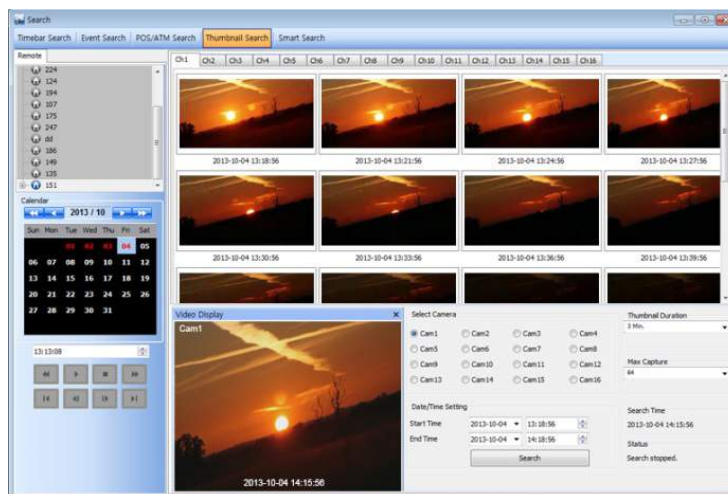

6.8.6 Smart Search

- Click the “connect” after right mouse clicking on the device and select the “Smart Search”.
- Choose a camera to use for Smart Search
- Users can select the area in an individual channel by dragging the certain area in “setting” menu. (More than 2 areas can be designated in the setting pane.)
- Specify the start time and end time in Date/Time setting and click “Search” button
- If the movement is detected in the area, it will automatically display the snapshots in the search window.
- Double click the listed snapshot images to check and play the video.

- Users are able to select the one from the 3 types of sensitivity level; Super, High and Standard.

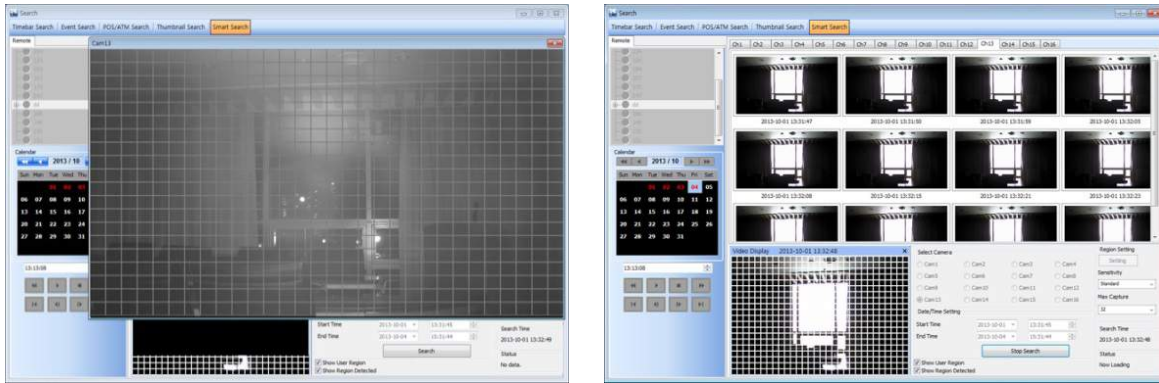

6.9 E-Map

6.9.1 Overview

- The 'Map Viewer' program is to display event signals over map images so that users may acknowledge event status more easily.
- Users may recognize event occurrence with visual notifications on icons over the map image and audible notifications on speaker system of a PC. By clicking on the camera icons on the map, users may launch 'Instant Viewer' window.
- To utilize 'Map Viewer' properly, users should configure map before running 'Map Viewer' program.
(Please refer to Local setup – E-map in chapter 6.4.5)

6.9.2 Controls

- Users can load the Map Viewer which was set up "in Local Setup - E-Map" by clicking right mouse button on the map in the map list.
- Users can check the information of the device connected E-map in the right side of the Map viewer such as Device status, name, IP / Domain, the maximum number of Camera, Alarm in / out and Audio.

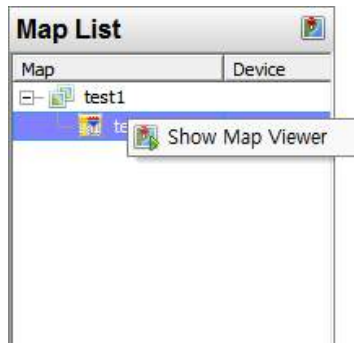

6.9.3 E-map Camera – Instant Playback

- Users are able to load the instant viewer by clicking the camera icon on the map.

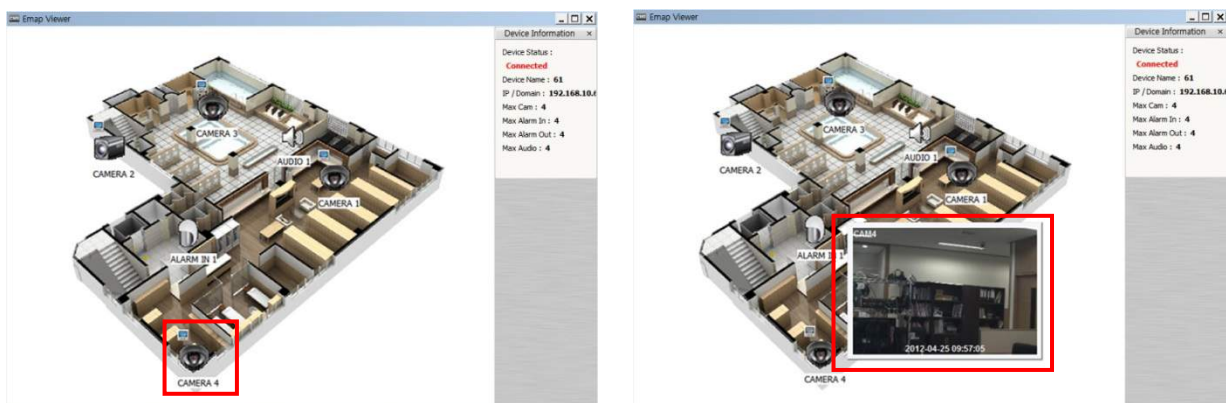

- Full screen mode is available by clicking right mouse button and select “Full screen”.
- Click audio icon to listen to the audio of the channel, if audio input connected.
- Click the alarm out icon to release a manual relay signal to the site such as siren or buzzer

6.9.4 Alarm In/Out Control

- The Alarm In icon on the map is blinking when the Alarm In equipment like sensor or detector is activated.
- Click the alarm out icon to release a manual relay signal to the site such as siren or buzzer.

6.9.5 Audio

- Click audio icon to listen to the audio of the channel, if audio input connected.



6.10 Uninstalling CMS Pro

- Please click the “Uninstall” file in the CMS Pro folder in the PC.

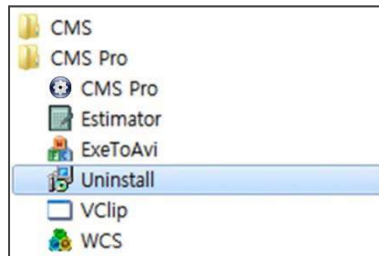

- Click the uninstall file and the following message box will pop up.
- Click “OK” to remove the program and its components.

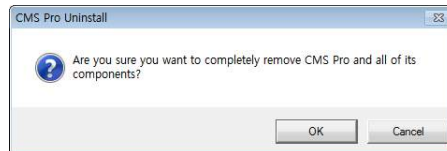

- If uninstall is complete successfully, the following message will pop up.



iCMS

User`s Manual



7. iCMS VIEWER

7.1 System Recommendations

	Recommended
CPU	Core 2 Duo 2.26GHz or higher
Main Memory	2GB or higher
Video Memory	512MB or higher
Display Resolution	1024 x 768 (with 32bit color) or higher
HDD Storage Space	30GB or higher
Network	100~1000 Mbps Fast Ethernet
Operating System	Mac OS 10.6.0 or higher

NOTE

It is recommended to connect Max. 16 HD-SDI (Full HD) cameras with iCMS.

WARNING

DUE TO A LIMITATION OF A MAC, CONNECTING MORE THAN 16 HD-SDI (FULL HD) CAMERAS MAY RESULT IN MALFUNCTIONING OF THE SOFTWARE. TO CONNECT MORE THAN 16 HD-SDI (FULL HD) CAMERAS, PLEASE ENABLE DUAL STREAMING OPTION ON THE DVR.

7.2 Program Installation

- Please follow the program installation procedures below.
- Open the file 'iCMS.dmg'.

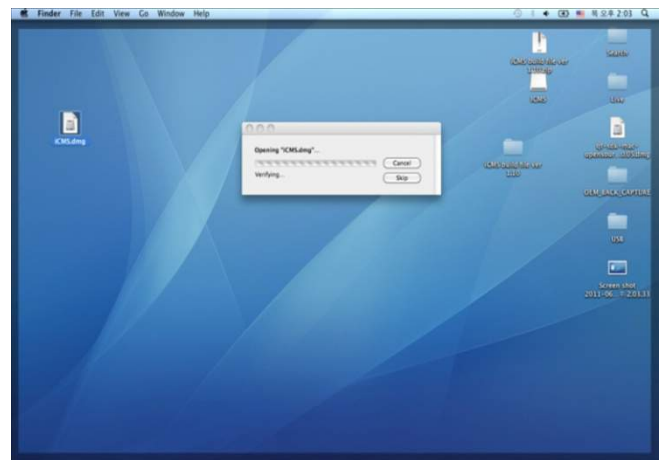

- Virtual driver will be installed (Driver name is "iCMS").

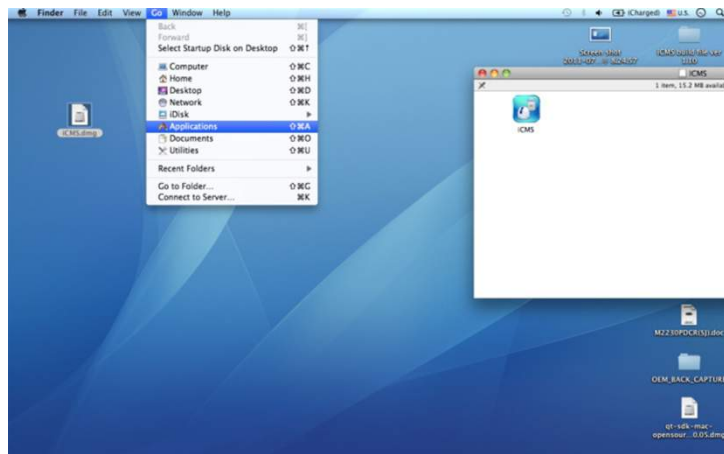

- In the virtual driver, users will find iCMS icon. Please move the iCMS icon to 'Application' folder ('Application' folder is located in the 'Go' Menu below).



7.3 Login

- After installation of the software, iCMS icon appears in 'Application' folder.
- Please double Click on the icon to execute the program.
- Select User Name by Clicking upside down arrow and enter corresponding Password to login.



7.4 Watch Mode

7.4.1 Log-in Screen

- Please Click 'Device manager' and the following screen will display.

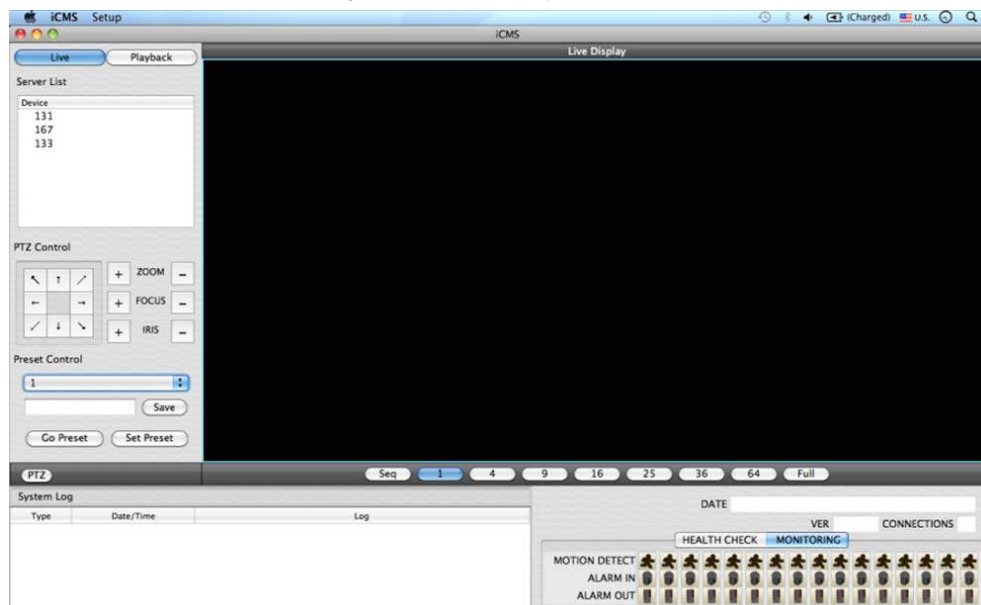

7.4.2 Local Setting

- Please Click '**Setup**' button on the top of the Toolbar and the following screen will display.
- There are three types of setup such as Device Manager, Display Setup and Password Change.

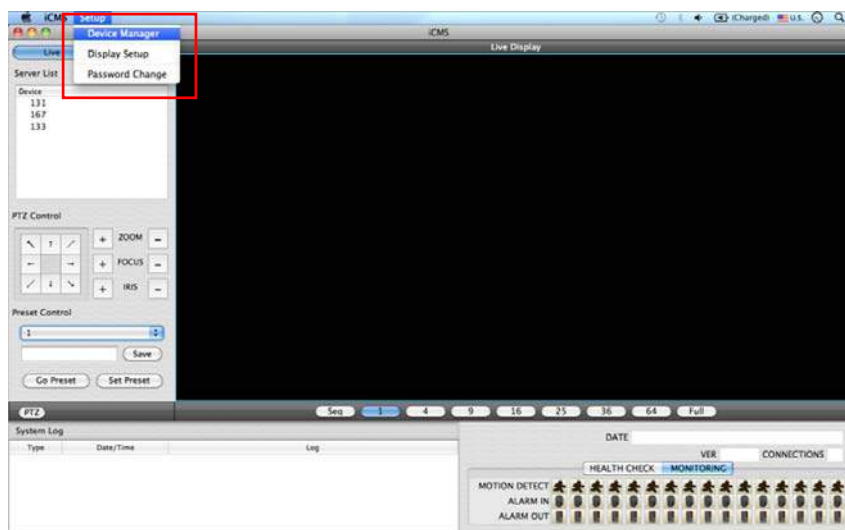

7.4.2.1 Display Manager

- Please Click '**Device manager**' and the following screen will display.

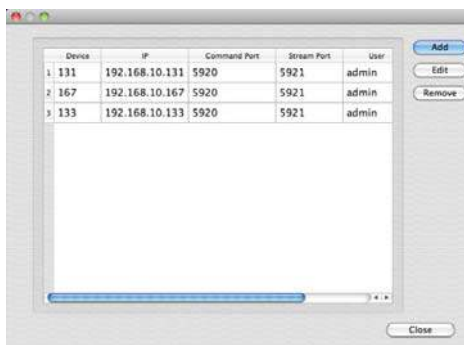

- Users will see the existing DVRs on the list, if there is any added DVR previously.
- Please Click '**Add**' to add new device.

The screenshot shows the 'Device Info' form. It contains the following fields:

- Device Name
- Description
- IP
- Command Port
- Stream Port
- User Name
- Password
- Confirm Password

Buttons for 'Scan Device', 'Cancel', and 'OK' are at the bottom.

- Please type all the necessary information in the empty space and Click 'OK' to submit the device information

• Device Info

- **Device Name:** input the DVR site name which will be displayed on the Server list. Please note that this name has nothing to do with the ID registered in DVR. Users may create the name that is fairly easy to distinguish.
- **Description:** type brief description of the site
- **IP Address:** input IP address or Domain Name of DVR (check with **SETUP>DEVICES>Network** in DVR).
- **Command Port:** input Administrator's number among port numbers set in DVR (check with **SETUP>DEVICES>Network** in DVR). (Default, 5920)
- **Stream Port:** INPUT Video/Audio number among port numbers set in DVR (check with **SETUP>DEVICES>Network** in DVR). (Default, 5921)
- **User Name:** Type authorized ID of the DVR. Default ID is **admin**.
- **Password:** Type corresponding password of the ID. Default Password is **1111**.
- **Confirm Password:** Retype the password to confirm.

- If users want to scan the devices instead of typing the information manually, please Click **'Scan device'**. It will automatically detect DVR units currently connected to local networks.
- Click **"Scan Device"**, then following **'Dialog'** will pop up.

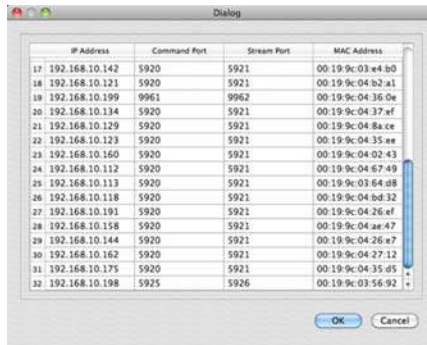

- Including IP address, the information of connected DVRs in the network will be listed.
- Select the one and Click **'OK'**. Then, the following window will pop up.



- Please fill out all the necessary information including Device name, Description (not mandatory), User Name and Password and confirm password. Please note that the User Name and Password have to be same as the DVR setting.
- When users want to edit the existing device information, please choose the device and Click **'Edit'**.
- When users want to delete the existing device information on the list, please select the device and Click **'Remove'**.
- If users click the **'Remove'** button, it will show the message below.



- Please Click the **'OK'** button to remove the connected device

7.4.2.2 Display Setup

- Please Click **'Display Setup'** and the following screen will display.

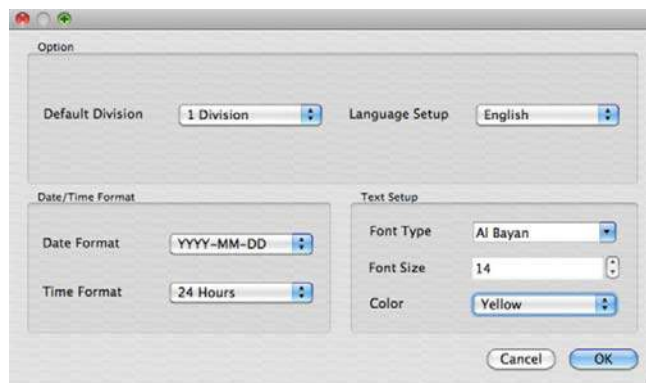

- Users can adjust and set the peripheral values of the display window.
 - Default Division: Users can select the number of division of display channels when the program initially starts the screen. (1, 4, 9, 16, 25, 36 or 64).
 - Users can choose either English or Korean in language setup.

NOTE

This option will be applied after program restarts.

- Date / Time format: Users can adjust and set the mode of date / time display in accordance with the location.
 - Date Format: select the date format among YYYY-MM-DD/MM-DD-YYYY/DD-MM-YYYY.
 - Time Format: select the time format between 24Hours/ 12 Hours AM/PM.
- Display Font: Users can change the font of the name and display time of each channel.
 - Font Type: select the type of font between Arial / Courier.
 - Font Size: select the size of the font from 10 to 20 and the default is 15.
 - Color: select the color among 16 different colors.

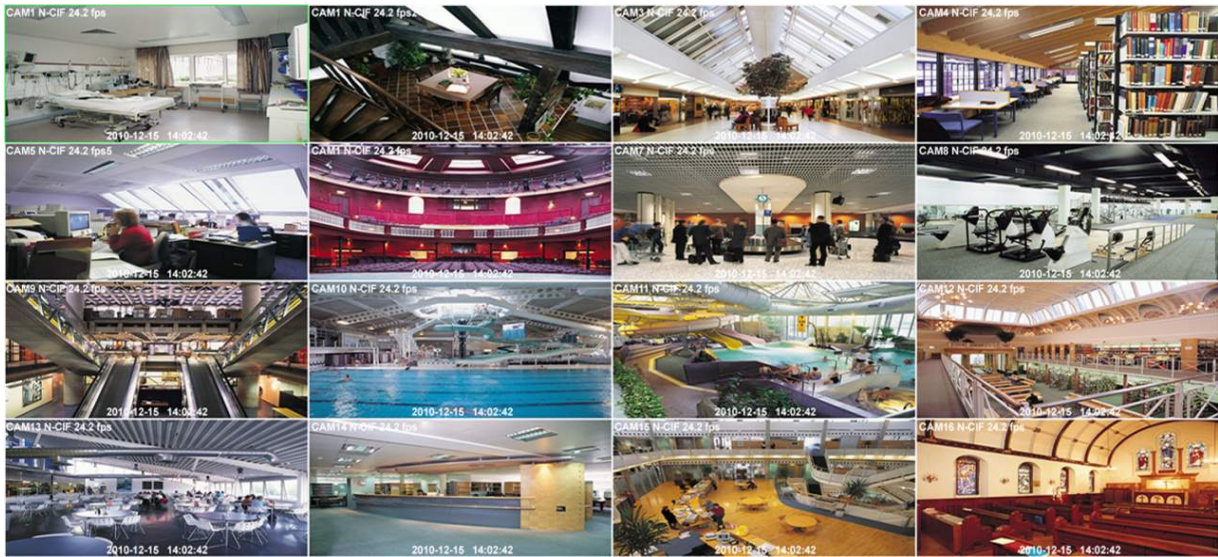

7.4.2.3 Password Change

- Please Click Password Change in setup menu to change the password. This ID and password is for opening the iCMS. This is not related to any DVR's login password



- Please select the ID from the drop down list and type original password.
- Please type new password and confirm the password below.
- If the information is filled out, click 'OK' to finish the Password change.

7.5 Live View

7.5.1 Connection

- Please choose one of the registered sites in Server list on the right hand side of the 'Live Display' screen and the right Click on the mouse button will pop up the menu with 'Connect'.
- Click 'Connect' to connect the DVR.

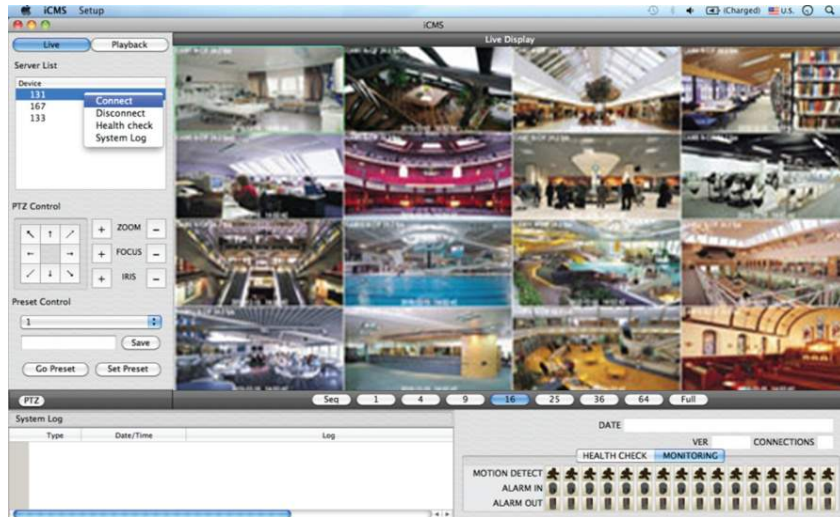

- To have multiple channels, please choose the channel from the bar below the 'Live Display' screen (1, 4, 9, 16, 25, 36, 64 and Full).

7.5.2 Display Mode

- Full Screen Mode: Select a channel and Click on number "1" button. Then, the corresponding channel will display in Full Screen.
- Quad Screen Mode: Click on No.4 button and a quad screen will display. The quad screen is in combination of 1~4, 5~8, 9~12 and 13~16. If users select Channel No. 7 and Click the button, 5~8 quad screen will display. Similarly, if users select Channel No. 16, 13~16 quad screen will display.
- 9-Split Screen Mode: Click on No.9 button and 9-split screen will display. The 9-split screen is in combination of 1~9 and 8~16. If users select Channel No. 9 and Click the button, 1~9 split screens will display. Similarly, if users select Channel No. 10, 8~16 split screens will display.
- 16-Split Screen Mode: Click on No.16 button and 16-split screens will display.
- 25-Split Screen Mode: Click on No.25 button and 25-split screens will display.
- 36-Split Screen Mode: Click on No.25 button and 36-split screens will display.
- 64-Split Screen Mode: Click on No.64 button and 64-split screens will display.
- Seq: Click 'Seq' and then it will show an ordered list of display which will change the channel of live display to next channels. For example, In 4 channel display CH5 to CH8 on the display screen will change to CH9 to CH12 consequently.

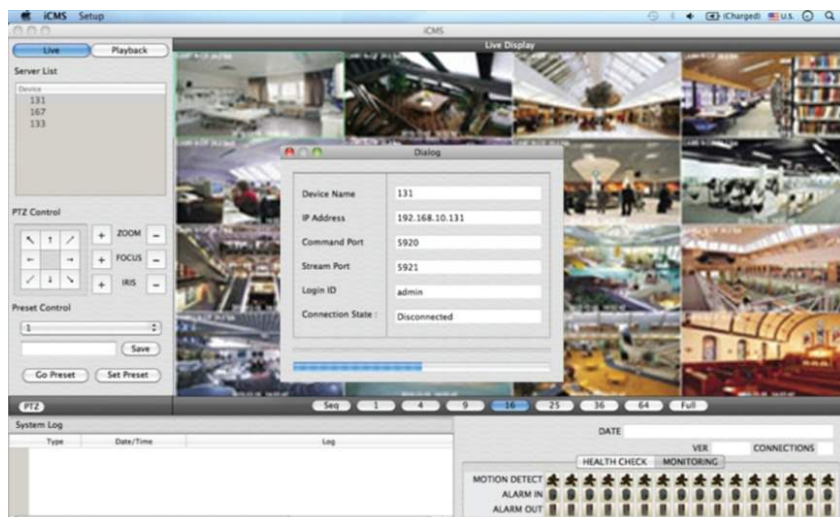

NOTE

The selected channel is outlined in blue

7.5.3 Health Check

- Please choose one of the registered sites in Server list and the right Click on the mouse button will pop up the menu with 'Health Check'.
- Please choose 'Health check' function when users want to check the status of the DVRs.
- Now users can choose either Health Check or Monitoring to see the status of the DVR at the bottom of the right corner.

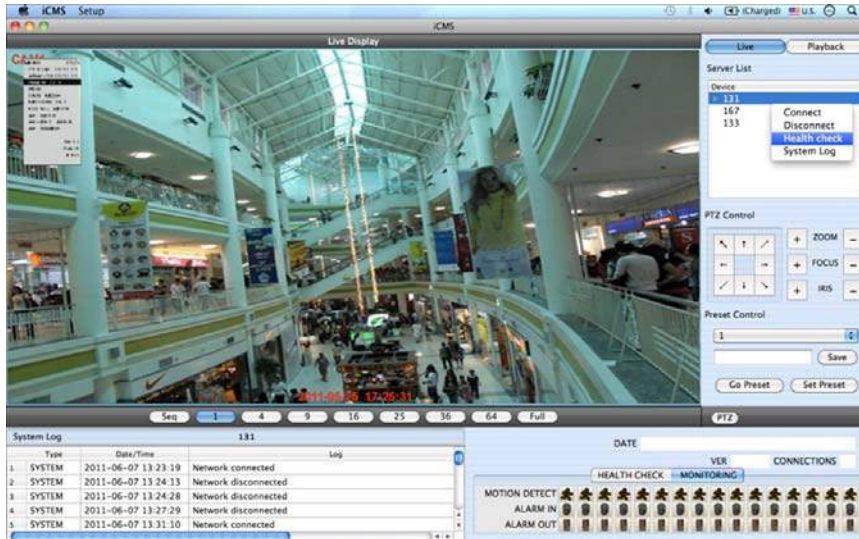

- Health check shows the status of how many cameras are activated, how many HDDs are available, and how many channels are recorded.
- Monitoring shows the status of the number of motion detection and how many alarm in and alarm out are activated.

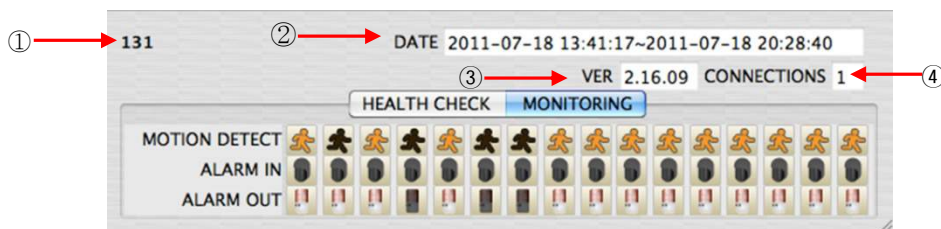

Number	Description
1	DVR name
2	Start and finish recorded date and time
3	The version of the firmware
4	The number of Connected network(ex. CMS, Mobile CMS, etc.) to the DVR

7.5.4 PTZ Control

- Under the server list, PTZ control can be found. This is for the control of Pan/Tilt/Zoom cameras.
- Buttons on the screen have the following functions.
 - Up/Down/Left/Right direction buttons



- Zoom In/Out, Focus Near/Far, Iris Close/Open

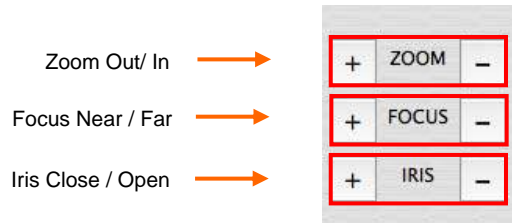

- Preset Control button



- Please choose the number from the drop down list from 1 to 256.
- After selecting the number, please type the description on the empty space below the drop down list and Click "Save".
- If users think that the certain spot is important or need to have precautions, then they can set up the spot as 'Preset'.
- When the preset is setup up, Click 'Go Preset' to move to preset spot.
 - PTZ control menu can be hidden by Clicking PTZ ICON below the PTZ menu.

7.5.5 System Log

- In the Live mode, system Log is shown. This will allow users to check System Log of Remote Site (DVR).

System Log		131	
Type	Date/Time	Log	
1	SYSTEM 2011-06-07 14:32:14	Network connected	
2	SYSTEM 2011-06-07 14:33:18	Network disconnected	
3	SYSTEM 2011-06-07 15:05:53	Network connected	
4	SYSTEM 2011-06-07 15:06:16	Network disconnected	
5	SYSTEM 2011-06-07 15:12:49	Network connected	

7.6 Search Mode

- This involves searching recorded video to playback the video of a specific date and time.
- Users are able to search the recorded data in the iCMS program by Date/Time, Event, and POS/ATM Search.
 - **Date/Time Search:** search by inputting date/time.
 - **Event Search:** search by event.
 - **POS/ATM Search:** search by POS or ATM text with time.

7.6.1 Date/Time Search

- Click Playback and following screen will display.



- Please choose one of the devices to playback from the Server List and right Click on the mouse to have popup menu with Connect.
- Select Date
 - In calendar, dates with recorded data are marked in red.
- Select the date among the dates marked in red.
- Select Time
 - Please select the time that users want to playback by Clicking ▲, ▼ buttons on the right-hand side to adjust the time or drag the Time Select Bar with mouse.

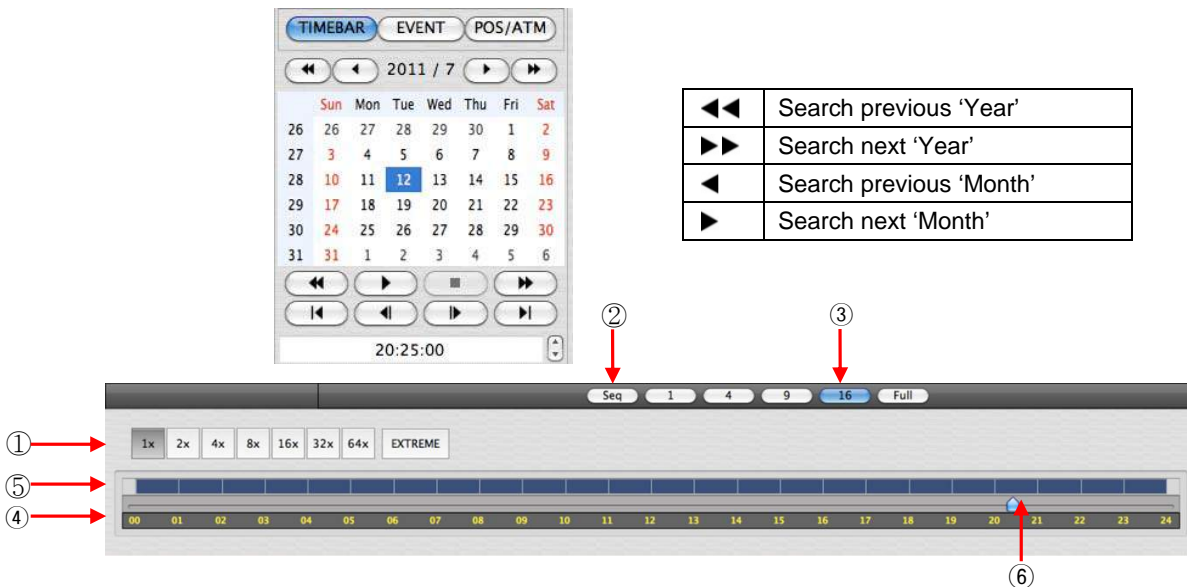

1	Fast Forward/Backward & Playback (Click the button to increase the speed by x1, x2, x4, x8, x16, x32, x64 and Extreme)
2	Sequence Mode
3	Display Mode (Click the button to divide the screen by 1, 4, 9, 16 and Full)
4	Time Bar (24 Hour)
5	Data Bar (Recorded data)
6	Time Select Bar

- When Date/Time search is completed, please Click Playback control button to begin playback.

7.6.2 Event Search

- The Event button allows users to search event recorded data of DVR.
- To start the event search, please Click **'EVENT'** and users will see the following screen.



- Please choose one of the devices among the **'Server List'** and right Click on the mouse to have popup menu with Connect.

- Please Click '**Connect**' to start the event search
- Event search has Event Type, Select Camera and Date/Time setting.
 - ① **Event Type:** it has Emergency, Alarm and Motion. Please choose one event that users want to use.
 - ② **Select Camera:** Please select the camera that users want to view from Cam1 to Cam 16 for the event (Only 1 camera can be selected).
 - ③ **Date/Time setting:** Please select the begin and end time by Clicking the up/down arrows and Click "Search"

7.6.3 POS/ATM

- POS/ATM button allows users to search for the POS/ATM text data by keyword.
- Please Click '**POS/ATM**' button right next to the '**EVENT**' and users will see the following screen.

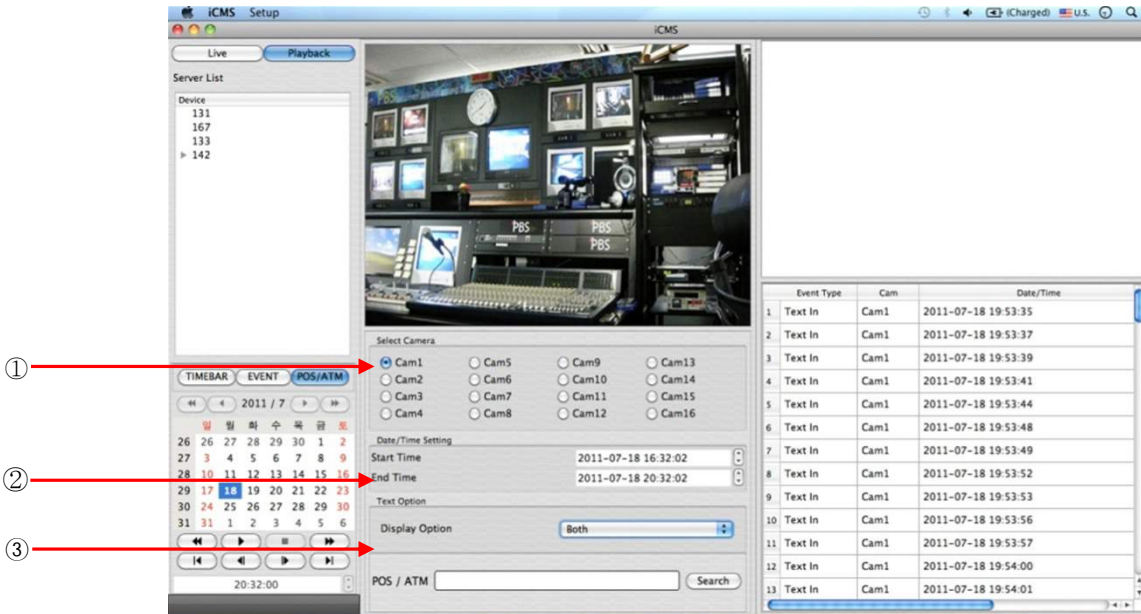

- Please choose one of the devices among the 'Server List' and right Click on the mouse to have popup menu.
- Please Click '**Connect**' to start the event search
- Event search has Event Type, Select Camera and Date/Time setting.
 - ① **Select Camera:** select a camera which has Text In connection to search (Only 1 camera can be selected).
 - ② **Date/Time setting:** please specify the start and end time
 - ③ **Text Option**
 - **Display Option:** Users are able to select the display option of the playback.
 1. Text window: The detected text will be shown on the '**Windows text**' right next to the '**Display screen**'.
 2. Overlay: The text will be overlaid on the playback video.
 3. Both: The text will be overlaid on the video and the text window as well.
 4. Hide All: The text will not be displayed in both video and the text window.

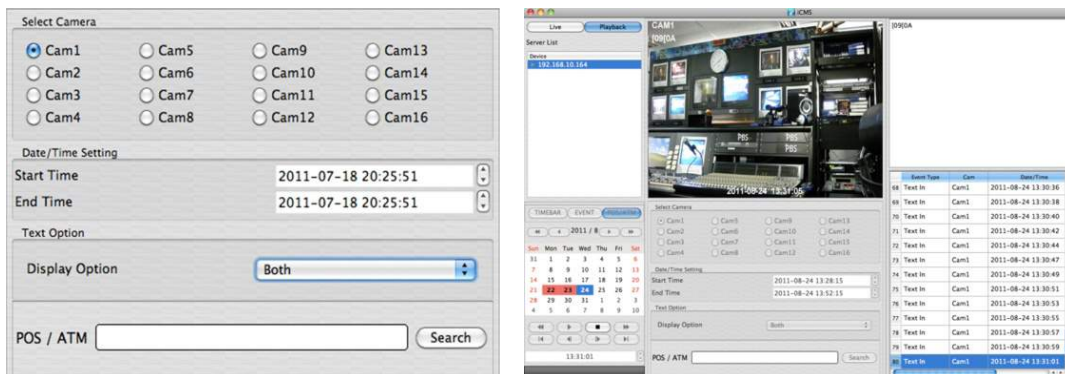

- Please fill out the text box with the searching keyword and click "Search".



- The following screen shows the result of the POS/ATM search.

Event Type	Cam	Date/Time
1 Text In	Cam1	2011-07-18 19:53:35
2 Text In	Cam1	2011-07-18 19:53:37
3 Text In	Cam1	2011-07-18 19:53:39
4 Text In	Cam1	2011-07-18 19:53:41
5 Text In	Cam1	2011-07-18 19:53:44
6 Text In	Cam1	2011-07-18 19:53:48
7 Text In	Cam1	2011-07-18 19:53:49
8 Text In	Cam1	2011-07-18 19:53:52
9 Text In	Cam1	2011-07-18 19:53:53
10 Text In	Cam1	2011-07-18 19:53:56
11 Text In	Cam1	2011-07-18 19:53:57
12 Text In	Cam1	2011-07-18 19:54:00
13 Text In	Cam1	2011-07-18 19:54:01

- Double Click on the event to playback of the data.

7.7 Disconnection

- When disconnect, please right Click on the connected site and choose 'Disconnect'

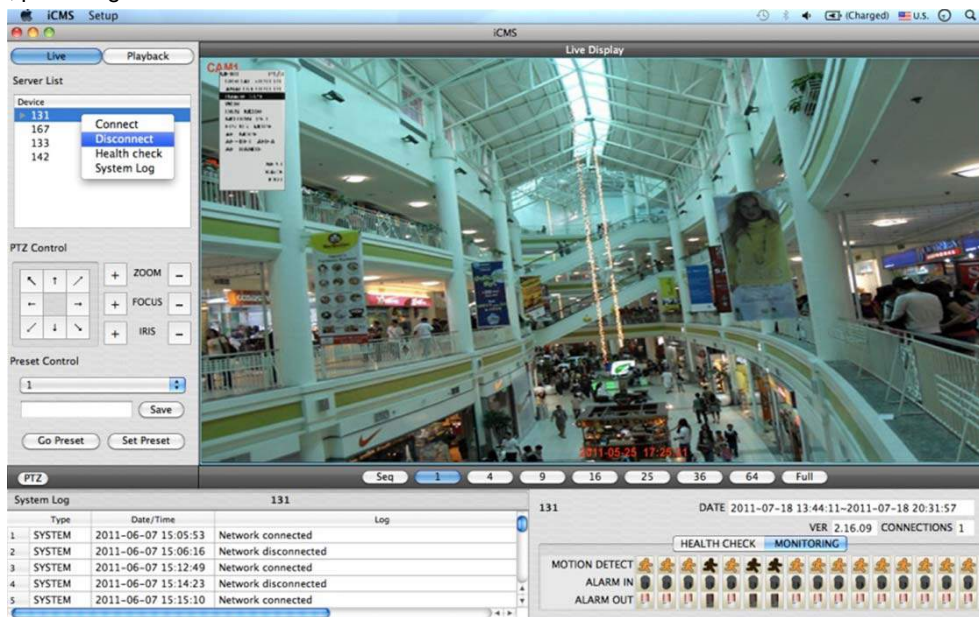

- if users Click 'Disconnect', the message box below will display

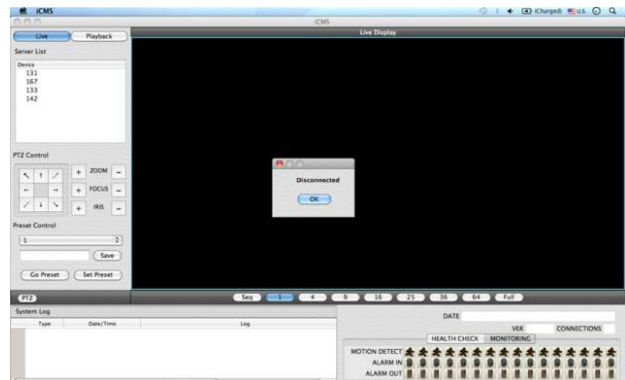
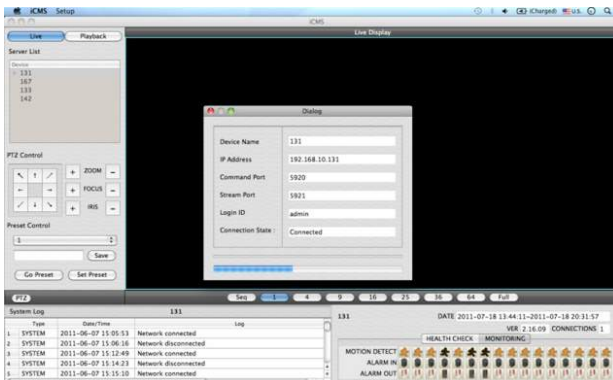

7.8 Uninstall

- Please go into the '**Application**' folder and right Click on the iCMS icon.



- Please choose '**Move to Trash**' to uninstall the iCMS program

xCMS

User`s Manual



8. xCMS VIEWER

8.1 Program Installation

8.1.1 System Recommendations

	Recommended
CPU	Core 2 Duo 2.26GHz or higher
Main Memory	2GB or higher
Display Resolution	1024 x 768 (with 32bit color) or higher
HDD Storage Space	30GB or higher
Network	100~1000 Mbps Fast Ethernet
Operating System	Fedora

NOTE

It is recommended to connect Max. 16 HD-SDI (Full HD) cameras with xCMS.

WARNING

DUE TO A LIMITATION OF A PC CONNECTING MORE THAN 16 HD-SDI (FULL HD) CAMERAS MAY RESULT IN MALFUNCTIONING OF THE SOFTWARE. TO CONNECT MORE THAN 16 HD-SDI (FULL HD) CAMERAS, PLEASE ENABLE DUAL STREAMING OPTION ON THE DVR.

8.1.2 Program Installation Method

- Please follow the program installation procedures below.
- Please select the **'Activities'** on the top left side of the corner, and choose Home directory



- Please select the **'xCMS'** file and move the file to the Home directory
- Right Click on the mouse and select **'Properties'**.



- Please select the **'Permission'** on the bar menu.

- Please check the box right next to the **“Allow executing file as program”** and if users want to give access to other groups, please change the access level to Read and write.

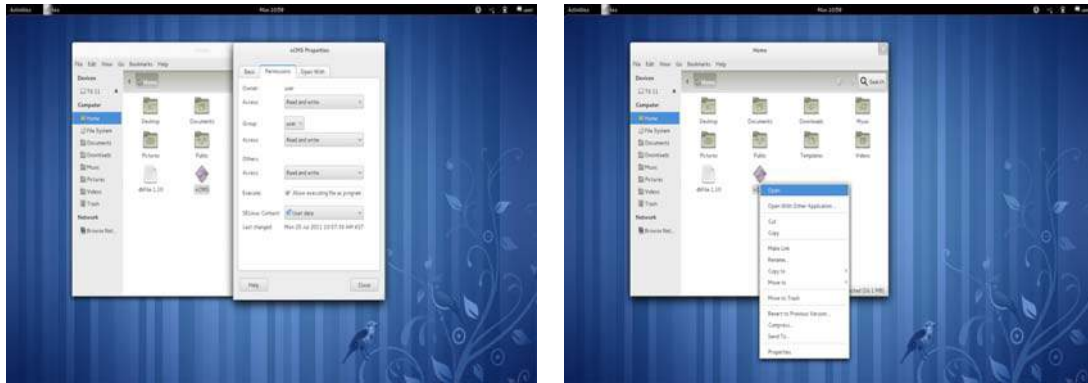

- Right Click on the 'xCMS' and select 'Open'

8.2 Login

- Please right-Click on the icon and select open to execute the program.
- Select User Name by Clicking upside down arrow and enter corresponding Password to login.

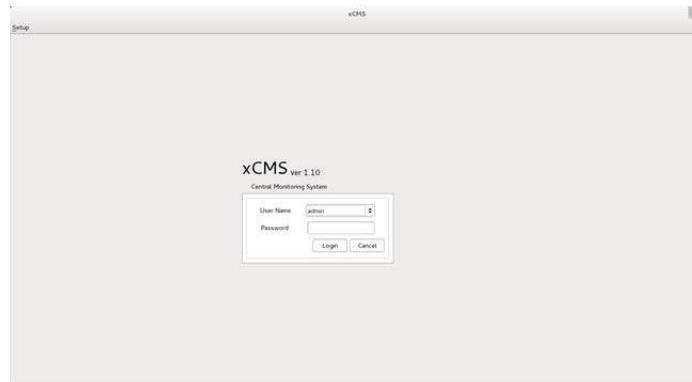

8.3 Watch Mode

8.3.1 Login Screen

- After users log into the 'xCMS', the following screen will display.



8.3.2 Local Setting

- Please Click **'Setup'** button on the top of the Toolbar and the following screen will display.
- There are three types of setup menu such as Device Manager, Display Setup and Password Change.

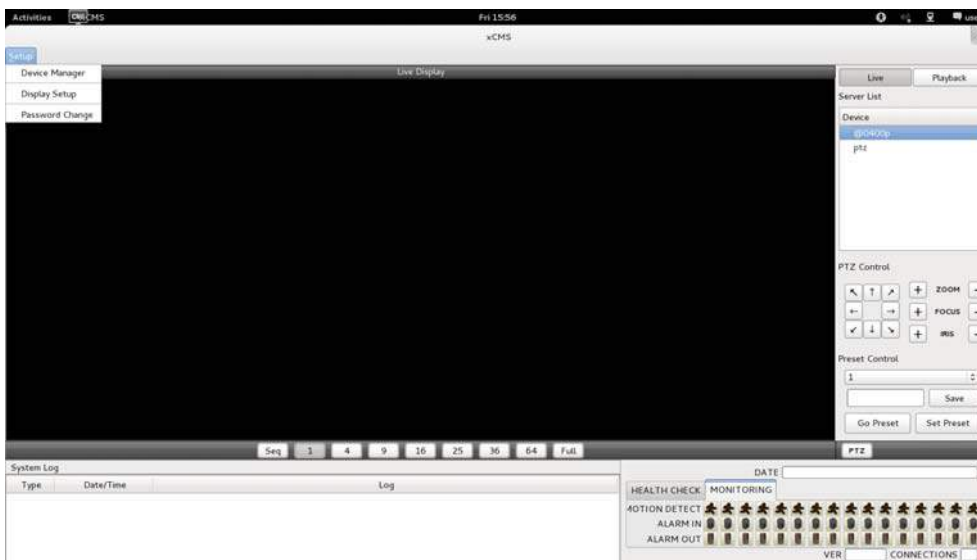

8.3.2.1 Device Manager

- Please Click **'Device manager'** and the following screen will display.

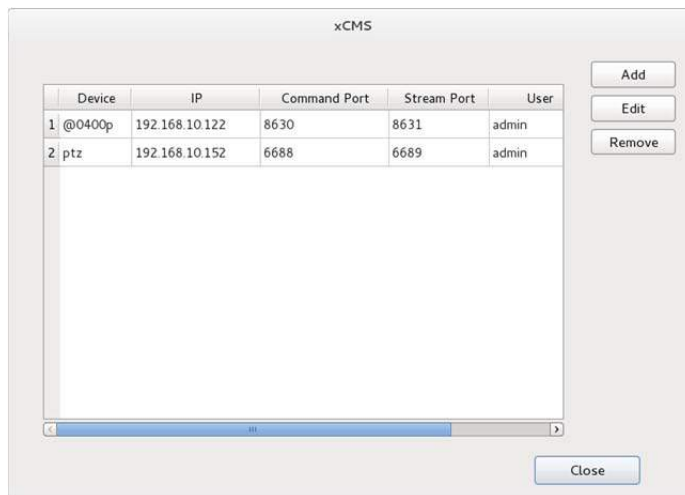

- Users will see the existing DVRs on the list, if there is any added DVR previously.
- Please Click **'Add'** to add new device.



- Please type all the necessary information in the empty space and Click **'OK'** to submit the device information

• **Device Info**

- Device Name: input the DVR site name which will be displayed on the Server list. Please note that this name has nothing to do with the ID registered in DVR. Users may create a name that is fairly easy to distinguish.
 - Description: type brief description of the site.
 - IP Address: input IP address or Domain Name of DVR (check with **SETUP>DEVICES>Network** in DVR).
 - Command Port: input Administrator's number among port numbers set in DVR (check with **SETUP>DEVICES>Network** in DVR). (Default, 5920)
 - Stream Port: INPUT Video/Audio number among port numbers set in DVR (check with **SETUP>DEVICES>Network** in DVR). (Default, 5921)
 - User Name: Type authorized ID of the DVR. Default ID is **admin**.
 - Password: Type corresponding password of the ID. Default Password is **1111**.
 - Confirm Password: Retype the password to confirm.
- If users want to scan the devices instead of typing the information manually, please Click '**Scan device**'. It will automatically detect DVR units currently connected to local networks.
 - Click "**Scan Device**", then following '**Dialog**' will pop up.



- Including IP address, the information of connected DVRs in the network will be listed.
- Select the one and Click '**OK**'. Then, the following window will pop up.
- Please fill out all the necessary information including Device name, Description (not mandatory), User Name and Password and confirm password. Please note that the User Name and Password have to be same as the DVR setting.
- When users want to edit the existing device information, please choose the device and Click 'Edit'.
- When users want to delete the existing device information on the list, please select the device and Click 'Remove'.
- If users click the 'Remove' button, it will show the message below.

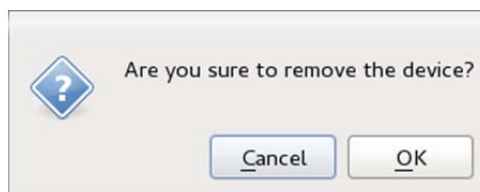

8.3.2.2 Display Setup

- Please Click '**Display Setup**' and the following screen will display.

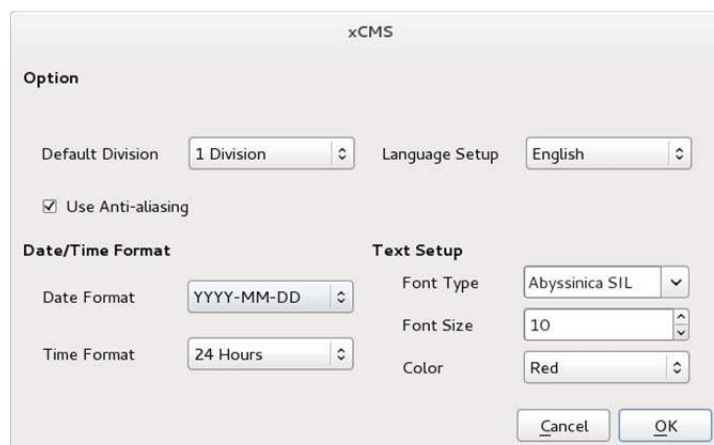

- Users can adjust and set the peripheral values of the display window.
 - Default Division: Users can select the number of division of display channels when the program initially displays the screen. (1, 4, 9, 16, 25, 36 or 64).
 - Users can choose either English or Korean in language setup.

NOTE

This option will be applied after program restarts.

- Date / Time format: Users can adjust and set the mode of date / time display in accordance with the location.
 - Date Format: select the date format among YYYY-MM-DD/MM-DD-YYYY/DD-MM-YYYY.
 - Time Format: select the time format between 24Hours/ 12 Hours AM/PM.
- Display Font: Users can change the font of the name and display time of each channel.
 - Font Type: select the type of font between Arial / Courier.
 - Font Size: select the size of the font from 10 to 20 and the default is 15.
 - Color: select the color among 16 different colors.



8.3.2.3 Password Change

- Please Click Password Change in setup menu to change the password.

The screenshot shows a 'Password change' dialog box in the xCMS software. It has a title bar with 'xCMS'. The dialog contains the following fields:

- ID:** A dropdown menu currently showing 'admin'.
- Password:** A text input field.
- New Password:** A text input field.
- Confirm Password:** A text input field.

 At the bottom of the dialog are two buttons: 'Cancel' and 'OK'.

- Please select the ID from the drop down list and type original password.
- This ID and password is for opening the xCMS. This is not related to any DVR's login password
- Please type new password and confirm the password below.
- If the information is filled out, click 'OK' to finish the Password change.

8.3.3 Live

8.3.3.1 Connection

- Please choose one of the registered sites in Server list on the right hand side of the 'Live Display' screen and the right Click on the mouse button will pop up the menu with 'Connect'.

- Click **'Connect'** to connect the DVR to the 'xCMS'.

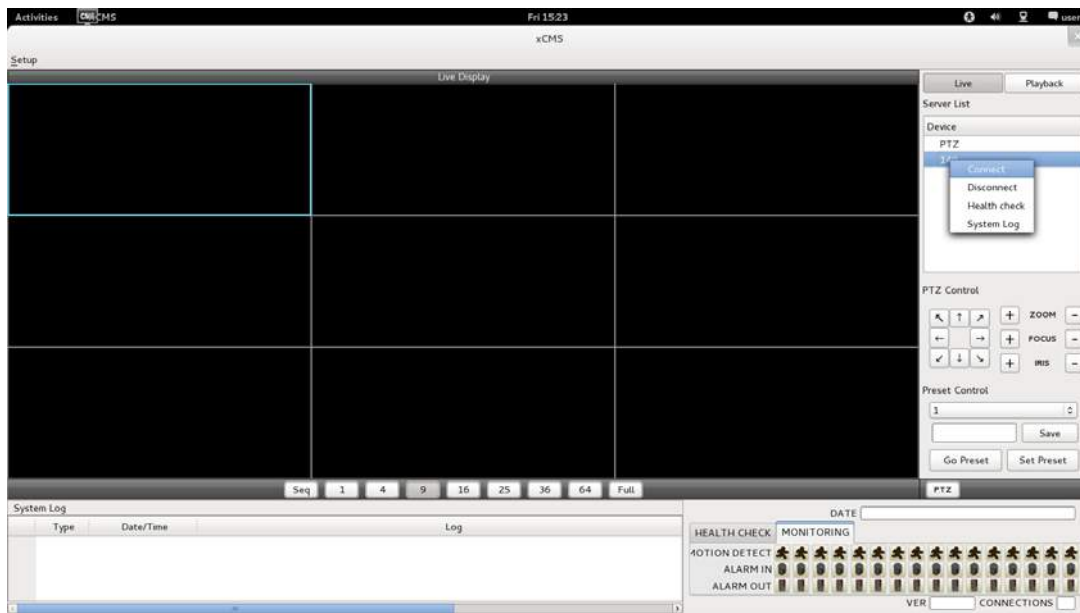

- To have multiple channels, please choose the channel from the bar below the **'Live Display'** screen (1, 4, 9, 16, 25, 36, 64 and Full).

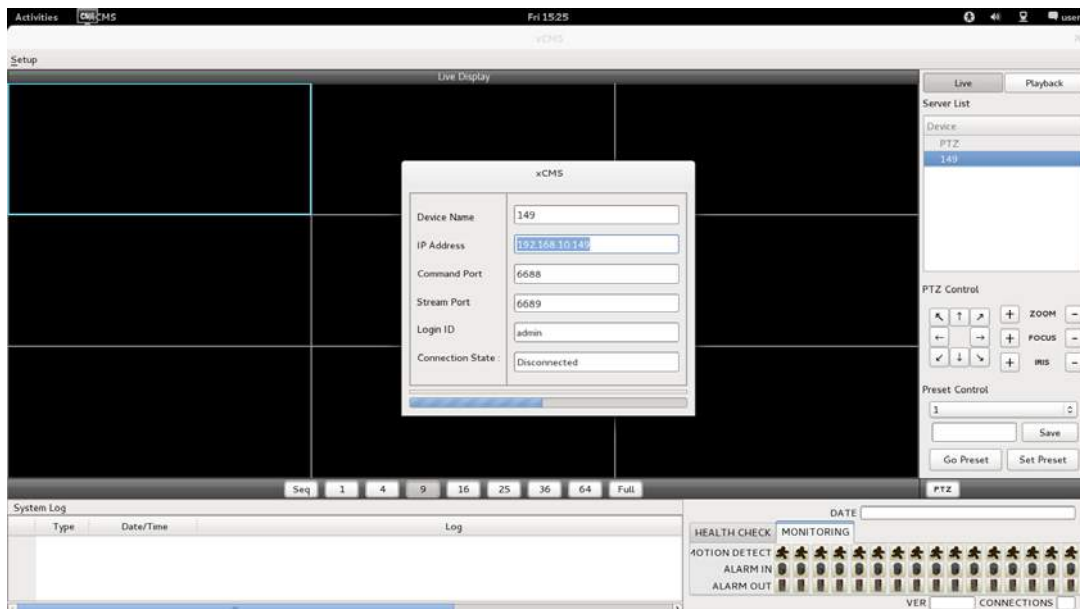

- **Full Screen Mode:** Select a channel and Click on number "1" button. Then, the corresponding channel will display in Full Screen.
- **Quad Screen Mode:** Click on No.4 button and a quad screen will display. The quad screen is in combination of 1~4, 5~8, 9~12 and 13~16. If users select Channel No. 7 and Click the button, 5~8 quad screen will display. Similarly, if users select Channel No. 16, 13~16 quad screen will display.
- **9-Split Screen Mode:** Click on No.9 button and 9-split screen will display. The 9-split screen is in combination of 1~9 and 8~16. If users select Channel No. 9 and Click the button, 1~9 split screens will display. Similarly, if users select Channel No. 10, 8~16 split screens will display.
- **16-Split Screen Mode:** Click on No.16 button and 16-split screens will display.
- **25-Split Screen Mode:** Click on No.25 button and 25-split screens will display.
- **36-Split Screen Mode:** Click on No.25 button and 36-split screens will display.
- **64-Split Screen Mode:** Click on No.64 button and 64-split screens will display.
- **Seq:** Click 'Seq' and then it will show an ordered list of display which will change the channel of live display to next channels. For example, In 4 channel display, CH5 to CH8 on the display screen will change to CH9 to CH12 sequentially.

NOTE

The selected channel is outlined in blue

8.3.3.2 Health Check

- Please choose one of the registered sites in Server list on the right hand side of the 'Live Display' and then right Click on the mouse button will pop up the menu with 'Health Check'.
- Please choose 'Health check' function when users want to check the status of the DVRs.
- Now users can choose either Health Check or Monitoring to see the status of the DVR at the bottom of the right corner.



- Health check shows the status of how many cameras are activated, how many HDDs are available, and how many channels are recorded.
- Monitoring shows the status of the number of motion detection and how many 'Alarm In' and 'Alarm Out' are activated.

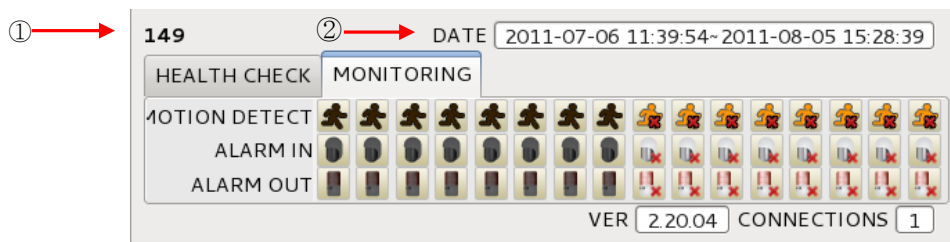

Number	Description
(1)	DVR name
(2)	Start and finish recorded date and time

8.3.3.3 PTZ Control

- Under the server list, PTZ control can be found. This is for the control of Pan/Tilt/Zoom of camera.
- Buttons on the screen have the following functions.
 - Up/Down/Left/Right direction buttons

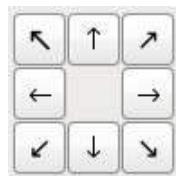

- Zoom In/Out, Focus Near/Far, Iris Close/Open

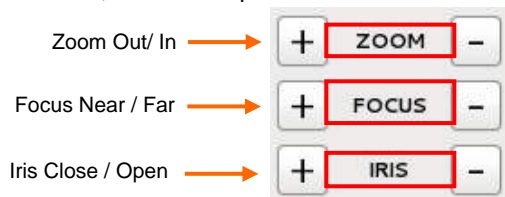

- Preset Control button



- Please choose the number from the drop down list from 1 to 256.
- After selecting the number, please type the description on the empty space below the drop down list and Click "Save".
- If users think that the certain spot is important or need to have precautions, then they can set up the spot as 'Preset'.
- When the preset is setup up, Click 'Go Preset' to move to preset spot.
 - PTZ control menu can be hidden by Clicking PTZ ICON below the PTZ menu.

8.3.3.4 System Log

- In the Live mode, system Log is shown. This will allow users to check System Log of Remote Site (DVR).

System Log		149	
	Type	Date/Time	Log
1	SYSTEM	2011-07-06 11:38:43	System start
2	SYSTEM	2011-07-06 11:43:50	Playback enter
3	SYSTEM	2011-07-06 11:44:12	Playback exit

8.4 Search Mode

- This involves searching recorded video to playback the wanted video of a specific date and time.
- Users are able to search the recorded data in the xCMS program by Date/Time, Event, POS/ATM Search.
 - **Date/Time Search:** search by inputting date/time.
 - **Event Search:** search by event.
 - **POS/ATM Search:** search by POS or ATM text with time.

8.4.1 Date/Time Search

- Click Playback and following screen will display.

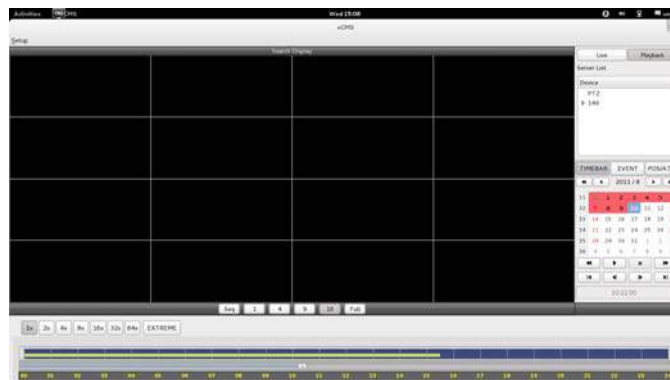

- Please choose one of the devices to playback from the Server List.
- Select Date
 - In calendar, dates with recorded data are marked in red.
- Select the date among the dates marked in red.
- Select Time
 - Please select the time that users want to playback by Click ▲, ▼ buttons on the right-hand side to adjust the time or drag the Time Select Bar with mouse.



◀◀	Search previous 'Year'
▶▶	Search next 'Year'
◀	Search previous 'Month'
▶	Search next 'Month'

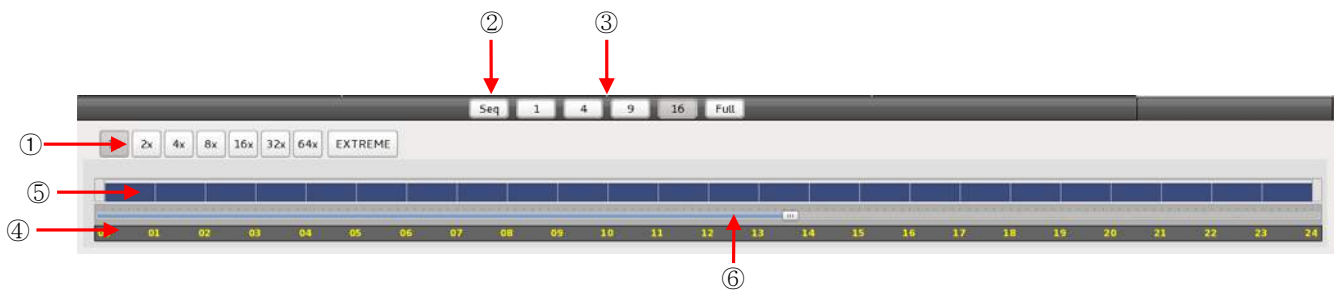

1	Fast Forward/Backward & Playback (Click the button to increase the speed by x1, x2, x4, x8, x16, x32, x64 and Extreme)
2	Sequence Mode
3	Display Mode(Click the button to divide the screen by 1, 4, 9, 16 and Full
4	Time Bar (24 Hour)
5	Data Bar (Recorded data)
6	Time Select Bar

- When Date/Time search is completed, please Click 'Play 
 button to begin playback.

8.4.2 Event Search

- The Event search allows users to search event recorded data of DVR.
- To start the event search, please Click '**EVENT**' and users will see the following screen

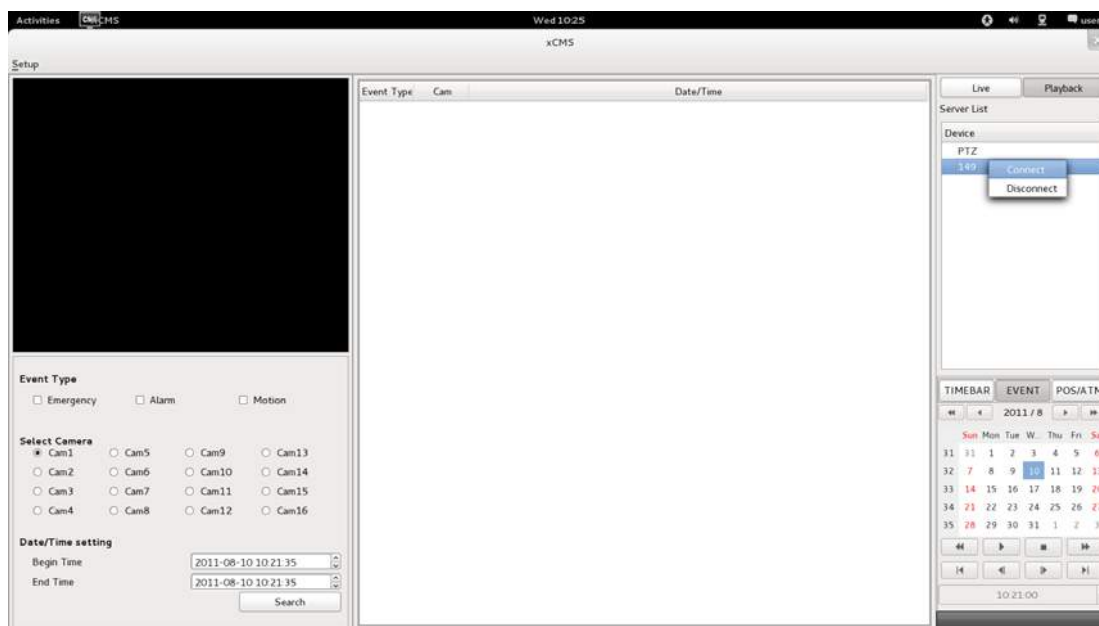

- Please choose one of the devices among the '**Server List**' and right Click on the mouse to have popup menu with Connect.
- Please Click '**Connect**' to start the event search
- Event search has Event Type, Select Camera and Date/Time setting.
 - ① **Event Type:** it has Emergency, Alarm and Motion. Please choose one event that users want to use.
 - ② **Select Camera:** Please select the camera that users want to view from Cam1 to Cam 16 for the event (Only 1 camera can be selected).
 - ③ **Date/Time setting:** Please select the begin and end time by Clicking the up/down arrows and Click "Search"

8.4.3 POS/ATM

- POS/ATM button allows users to search for the POS/ATM text data by keyword.
- Please Click **'POS/ATM'** button right next to the **'EVENT'** and users will see the following screen.

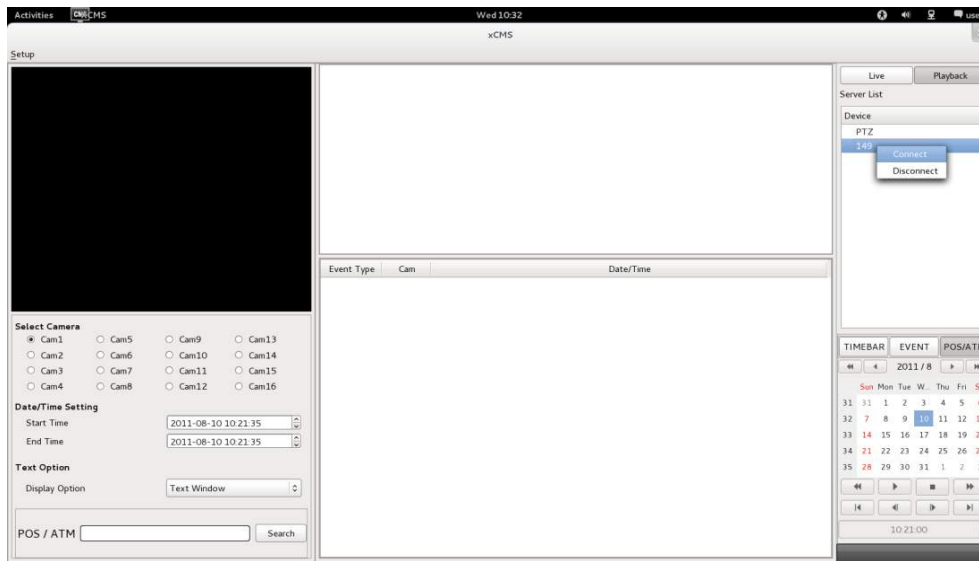

- Please choose one of the devices among the 'Server List' and right Click on the mouse to have popup menu.
- Please Click **'Connect'** to start the event search
- Event search has Event Type, Select Camera and Date/Time setting.
 - ① **Select Camera:** select a camera which has Text In connection to search (Only 1 camera can be selected).
 - ② **Date/Time setting:** please specify the start and end time
 - ③ **Text Option (Display Option:** Users are able to select the display option of the playback.)
 - Text window: The detected text will be shown on the **'Windows text'** right next to the **'Display screen'**.
 - Overlay: The text will be overlaid on the playback video in the **'Display Screen'**.
 - Both: The text will be overlaid on the video and the text window as well.
 - Hide All: The text will not be displayed in both video and the text window.

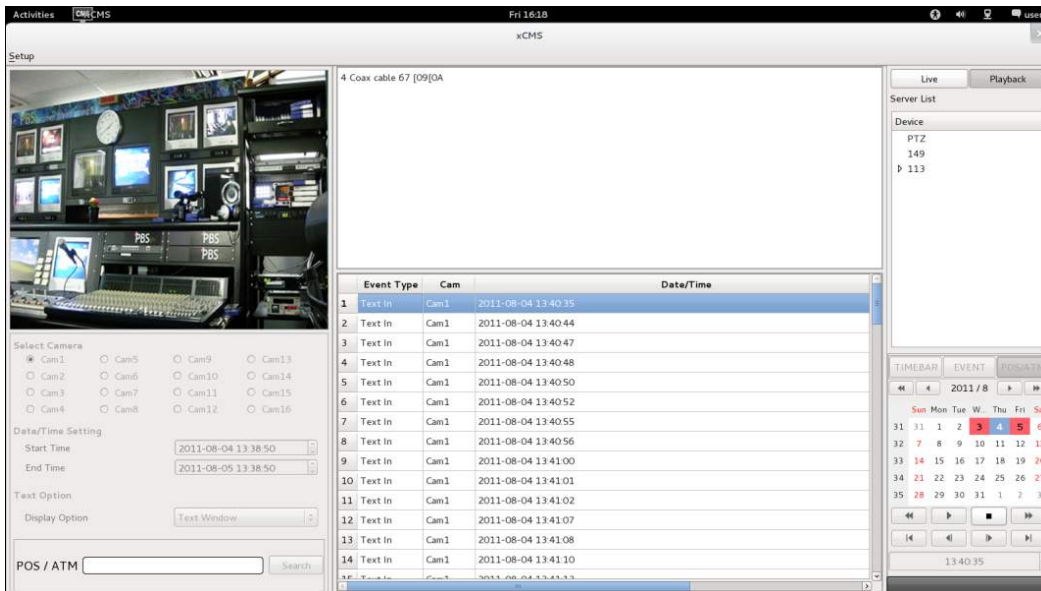

- To search the word, please fill out the text box with the searching keyword.



- Please Click 'Search'.

- The following screen shows the result of the POS/ATM search

Event Type	Cam	Date/Time
1	Text In	Cam1 2011-08-04 13:40:35
2	Text In	Cam1 2011-08-04 13:40:44
3	Text In	Cam1 2011-08-04 13:40:47
4	Text In	Cam1 2011-08-04 13:40:48
5	Text In	Cam1 2011-08-04 13:40:50
6	Text In	Cam1 2011-08-04 13:40:52
7	Text In	Cam1 2011-08-04 13:40:55
8	Text In	Cam1 2011-08-04 13:40:56
9	Text In	Cam1 2011-08-04 13:41:00
10	Text In	Cam1 2011-08-04 13:41:01
11	Text In	Cam1 2011-08-04 13:41:02
12	Text In	Cam1 2011-08-04 13:41:07
13	Text In	Cam1 2011-08-04 13:41:08
14	Text In	Cam1 2011-08-04 13:41:10

- Double Click on the event that users want to display.

8.5 Disconnection

- When disconnect, please right Click on the connected site and choose 'Disconnect'

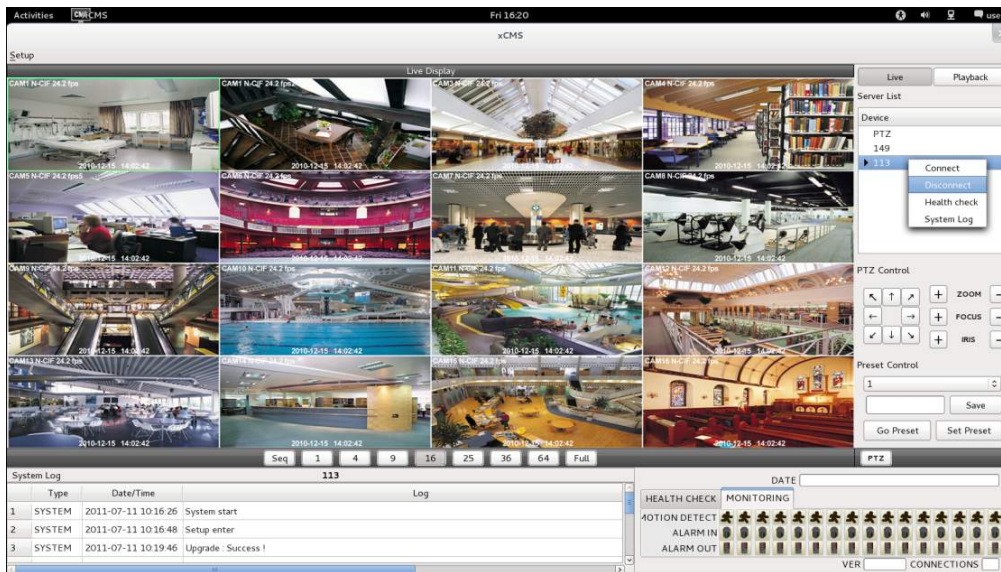

- Once users Click 'Disconnect', following screen will display with the message of 'Disconnected'.

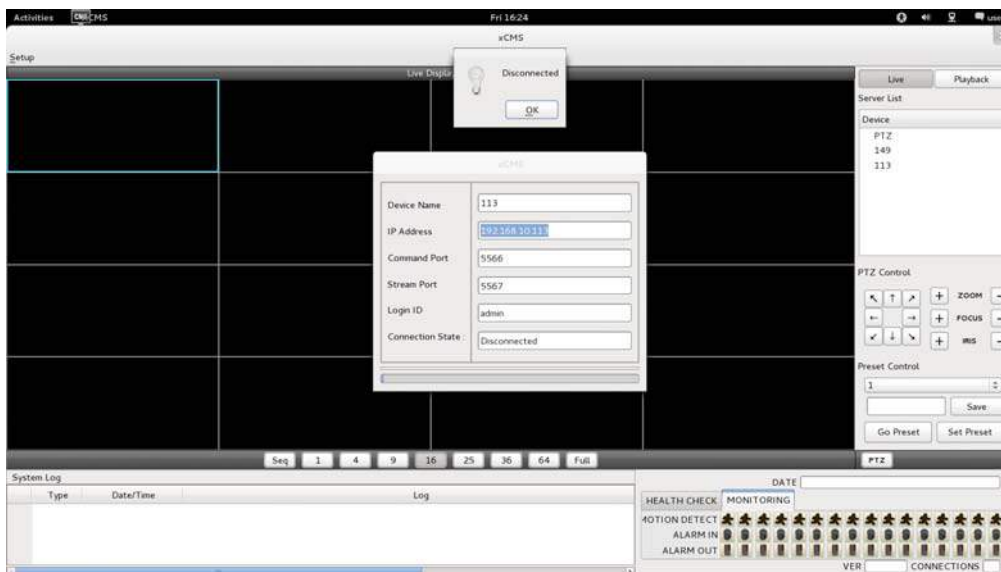

8.6 Uninstall

- Please go into the 'Home' folder and right Click on the xCMS icon.
- Please choose 'Move to Trash' to uninstall the xCMS program.

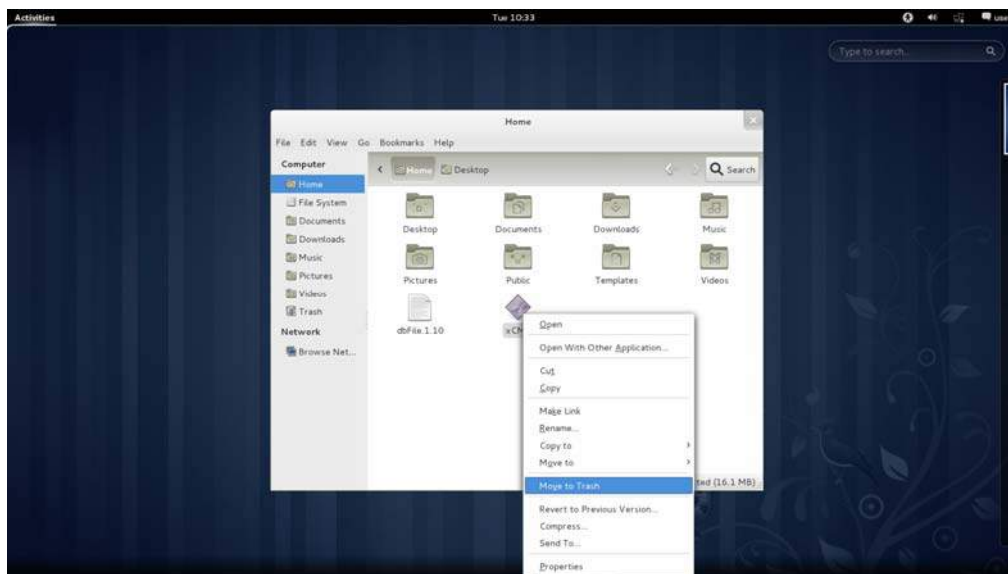

CMS Web Client Pro

User`s Manual

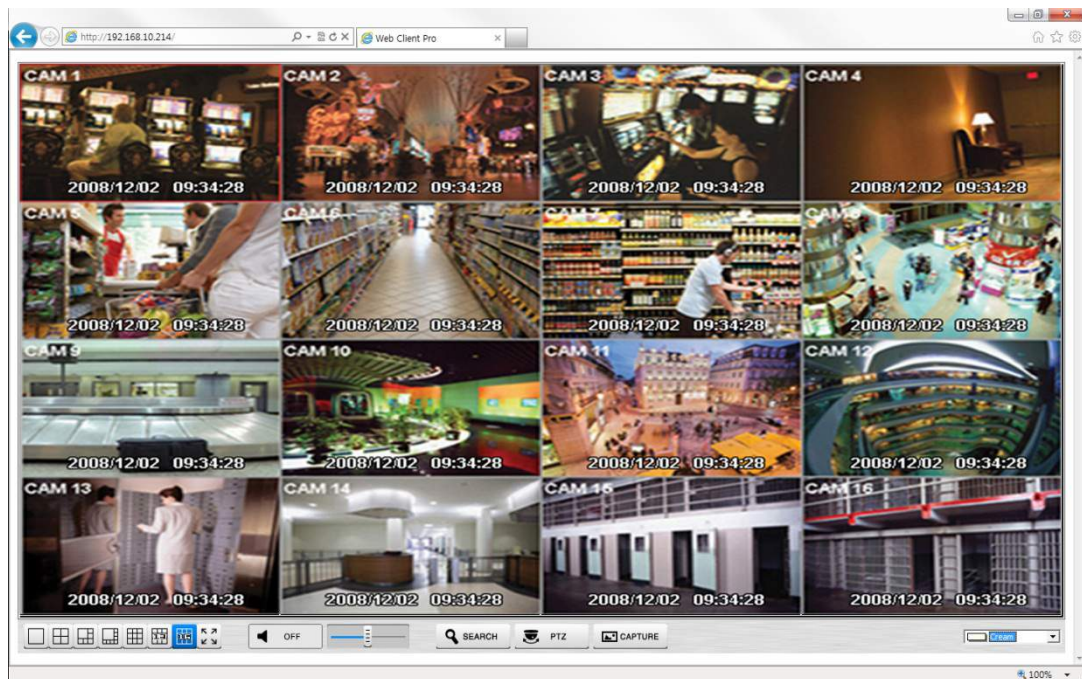

9. CMS WEB CLIENT Pro

9.1 System Requirements

- Web Client Pro may not run properly if the PC does not meet minimum requirements. Other programs should not run on the same PC where this is running. Otherwise, Web Client Pro software may not perform as designed.

	Minimum (Enable Dual Streaming)	Recommended (Disable Dual Streaming)
CPU	Intel Core i5	Intel Core i7
Main Memory	2GB	4GB or higher
Video Memory	1GB	2GB or higher
Display Resolution	1024 x 768 (with 32bit color) or higher	
HDD Storage Space	160GB or higher	
Network	100~1000 Mbps Fast Ethernet	
Operating System	Windows XP Professional SP3 / Windows 7 (32/64) / Windows 8 (32/64)	
Others	DirectX 9.0 C or higher	

9.2 Setup and Login

- MS Explorer web browser is required to install ActiveX in order to use this program.
- Open a browser and type the IP address of DVR. It is required to install ActiveX in the first connection.
- Click the message above in the screen, then following menu box will display.

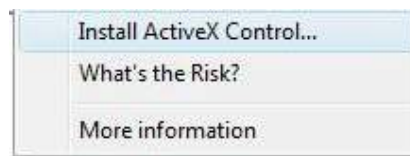

- Click "Install ActiveX Control..." and start installation.
- Installation box will displays and Click "Install" for next step.
- After complete installation, Login panel will display.
- Enter User ID and password of registered DVR then Click "OK"

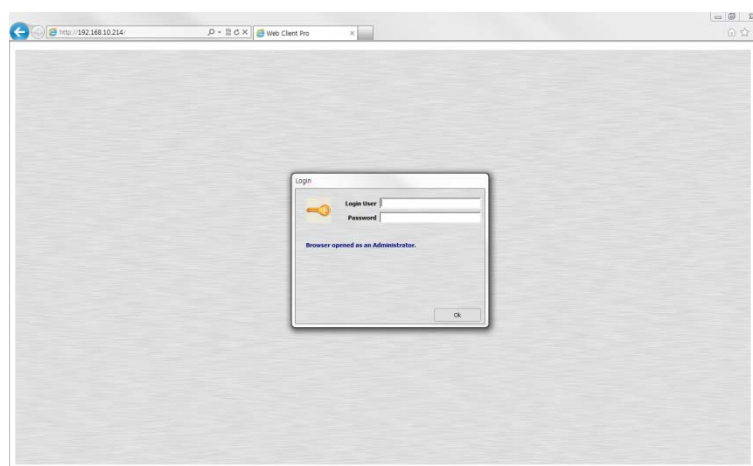

NOTE

Before network connection, be sure that HDD is installed. Otherwise, the DVR will not be connected over network.

9.3 Live Display

• After Login, following screen will display.

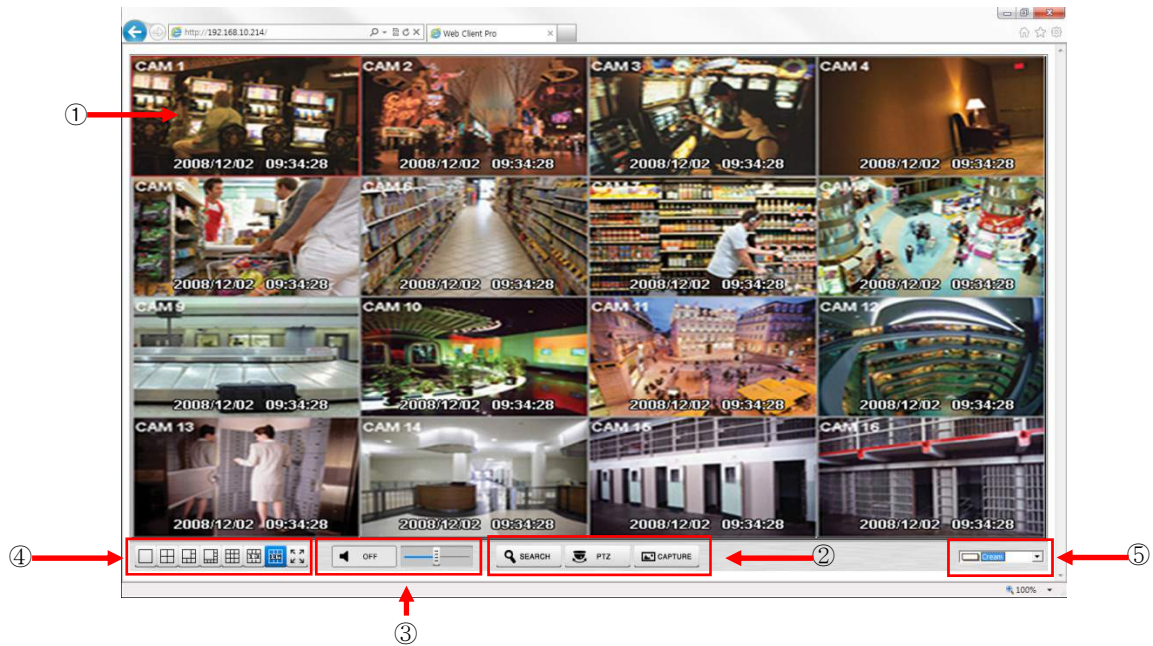

• The screen contains following features:

- ① Display current live video
- ② Setting display mode
 - Search: Opening search mode in new window.
 - PTZ: Open PTZ control panel.
 - Capture: Capturing the image of selected channel.
- ③ Audio controller
 - Able to control the volume.
- ④ Select display split mode. A user can choose 1, 4, 6, 8, 9, 13, 16 and Full screen.
- ⑤ OSD Font color
 - Able to change the color of the OSD font.

• Additional features can be found with Right Click on Live screen.

- ① Digital zoom(1CH Display ONLY)
 - Able to Zoom in for precise monitoring.
- ② Audio On/Off
 - Able to turn on/off Audio function.
- ③ Display Option
 - Show Camera Name: Display Camera Name on OSD
 - Show Date/Time: Display Date/Time on OSD
- ④ About
 - Display version information.

9.4 Search Screen

- Click  then following screen will display on a new window.

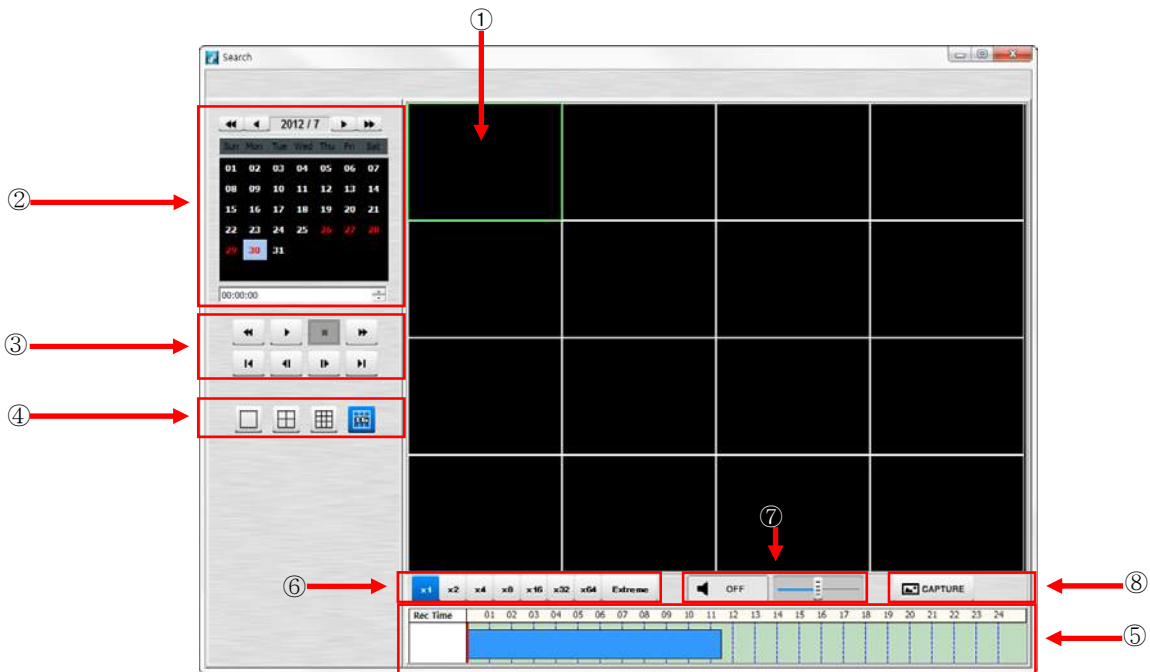

- The screen contains following features:

- ① Searched playback video displays.
- ② Setting Date/Time to search.
 - Click a date in calendar, and then recorded data will be showed up in Time bar.
 - Start Time: Setting starts time.
 - Camera: Choosing camera number from 1~16 individually or all channels.
- ③ Play functions for playback.

	Fast Backward Play
	Fast Forward Play
	Play
	Stop
	Go to the First Image
	Go to the Last Image
	Go to the Previous Image
	Go to the Next Image

- ④ Select display split mode. A user can choose 1, 4,9,16 split displays consequently.
- ⑤ Indicate the recorded data in Time bar figure.
- ⑥ Select playback speed. A user can choose x1, x2, x4, x8, x16, x32, x64 and Extreme.
- ⑦ Audio controller
 - Able to turn on/off Audio.
 - Able to control the volume
- ⑧ Capturing the image of selected channel.

9.5 PTZ Control

- Click  PTZ then following screen will display on a new window.

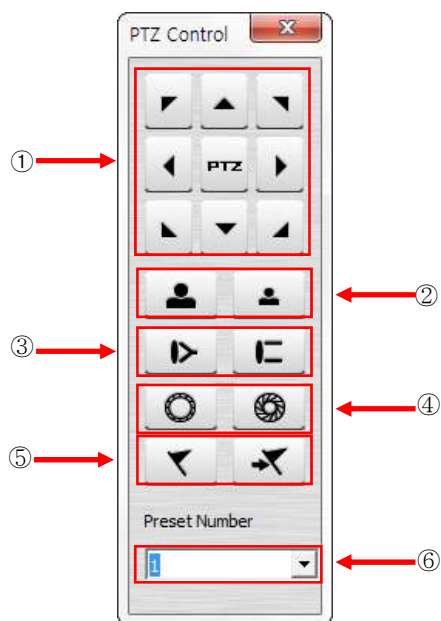

- The screen contains following features:

- ① Pan/Tilt Direction button.
- ② Zoom In / Zoom Out control button.
- ③ Focus Near / Focus Far control button.
- ④ Iris control button
- ⑤ Preset control button
- ⑥ Camera select button.

NOTE

Must complete the control setting on its DVR and Cameras first.

9.6 Capture

- Click  then following screen will display on a new window.

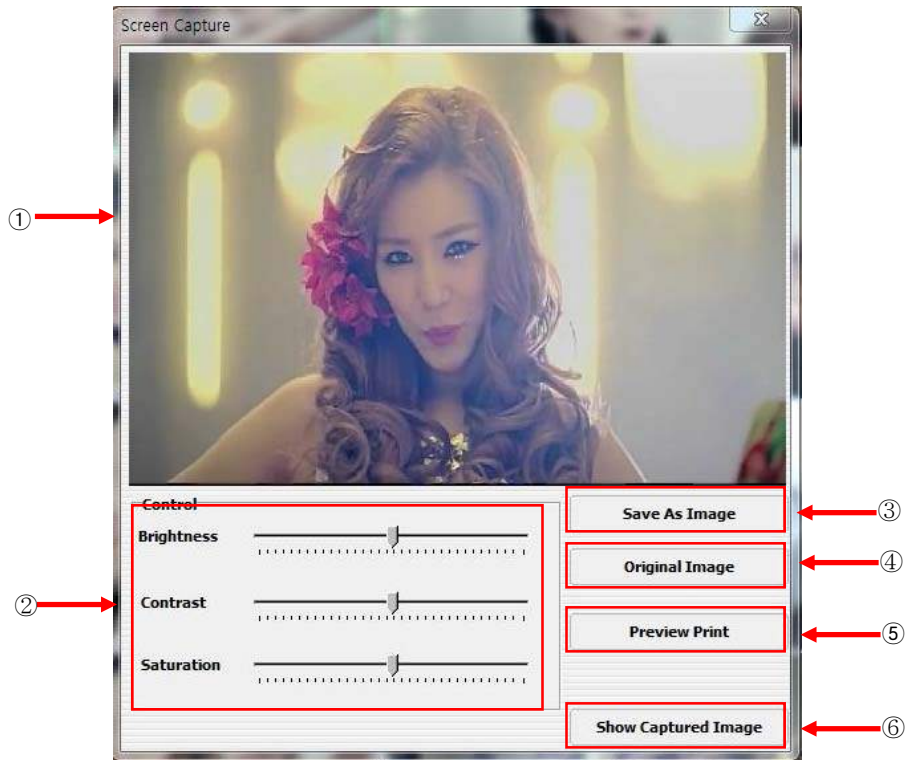

- The screen contains following features:

- ① Captured Image is displayed.
- ② Color Control
 - A user can change Brightness, Contrast and Saturation of the captured image.
- ③ Save as Image
 - A user can save the edited image in new name.
- ④ Original Image
 - A user can undo all modification made to the image.
- ⑤ Preview Print
 - Able to see print preview.
- ⑥ Show Captured Image
 - Display all the previous captured images

CMS Mobile Viewer

User`s Manual



10. CMS MOBILE VIEWER

10.1i Phone / iPad (AVY Viewer HD)

10.1.1 System Requirements

- There are no other requirements to run this program because it is specialized to perform on iOSs interface.

10.1.2 Installation

- Turn on the iPhone or iPad then connect to App Store.
- Move to search menu and type “AVY Viewer HD” then tap “ **Search** ”.

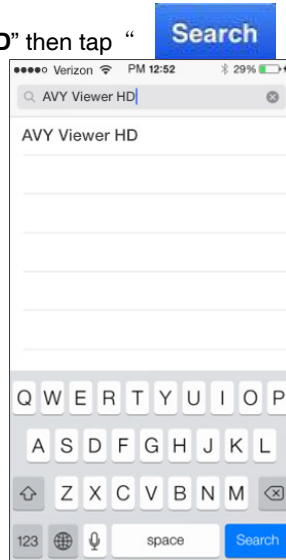

- Select “  ” program which is offered by dvrdomain for free.

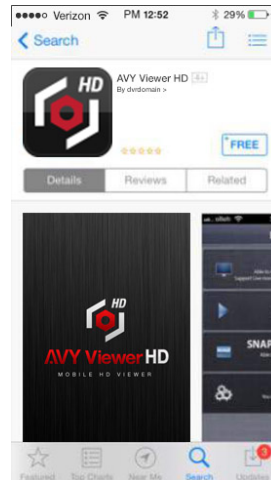

- When a user tap a “ **FREE** ” button, it will be turned to “ **INSTALL** ”
- Tap “ **INSTALL** ” to start installation.

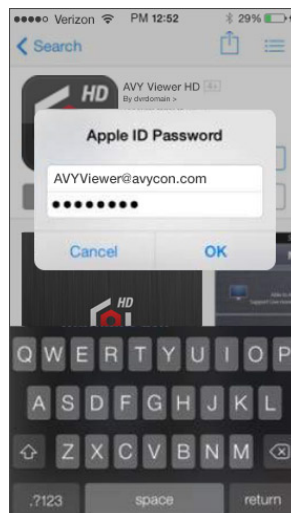

- If a user does not have the account, then Tap “  ” and it is registered by free.

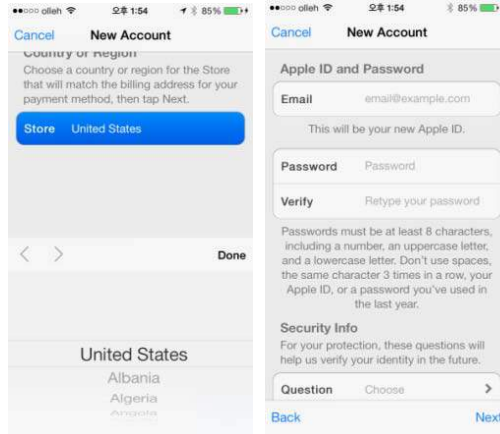
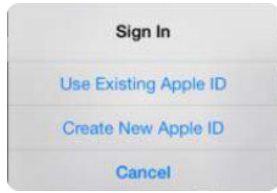

NOTE

'AVY Viewer HD' supports iOS6 or higher version, if you use lower iOS with older device, please install 'AVY Viewer HD'





10.1.3 Site Registration

- Tap “  ” icon on iPhone or iPad then below will show.

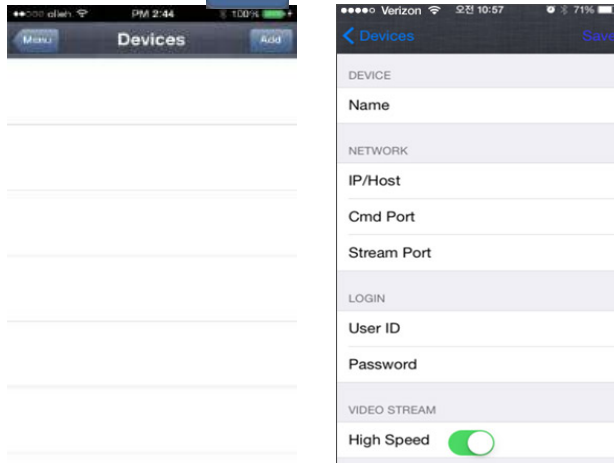

- Tap “ **MONITORING** ” then below will show and tap “  ” on top right corner.



- Enter Site Name, IP or DDNS address.
- Enter Admin/Stream port value. (Default, 5920/5921)
- Enter ID/Password. (Default, admin/1111)
- Tap “  ” to save the setting.

- To edit the saved site, tap “  ” next to site Name, then change the value, and tap “  ”.



- To delete the saved site, slide the finger from right to left across Device Name. Then tap **Delete** to remove the site.

NOTE

Please tap 'Off' in "High Speed" to see high quality video when the network condition is good. Otherwise, the video would be lagged.

NOTE

Please tap 'On' in "High Speed" for better transmission when the network condition is bad.

NOTE

"Video Stream" does not apply when the dual streaming is on in the device.

NOTE

"Video Stream" cannot be applied to some old models. Please keep your device with the latest firmware version.





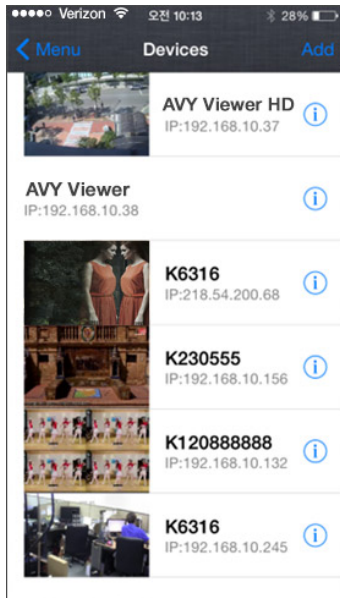

10.1.4 Connection

- Tap on Device Name to connect the DVR to iPhone or iPad



10.1.5 Live View (Portrait View)



- To select other channels,
 - Slide finger from Right to Left to ascend. (1 → 2 → 3 14 → 15 → 16)
 - Slide finger from Left to Right to descend. (16 → 15 → 14 3 → 2 → 1)
- Tap  to take Snapshot.
- Tap  to enable Frame skip or Tap  to disable Frame skip.
- Tap “     ” to choose split mode between 1, 4, 9 and 16.

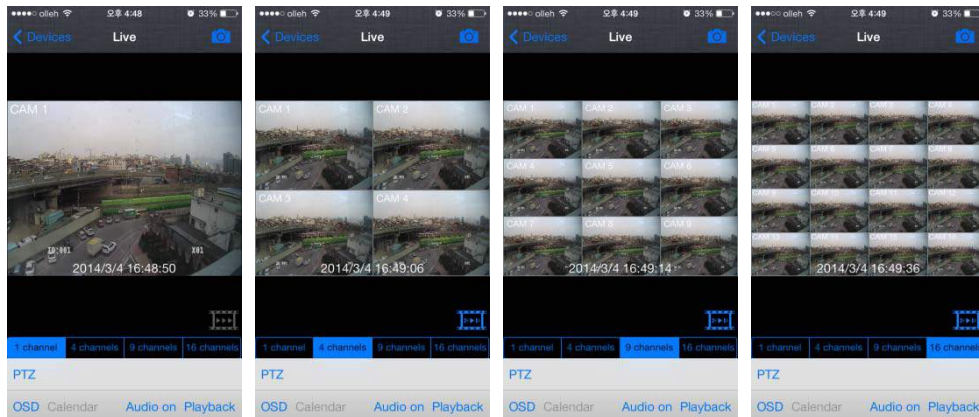

-In Multi-channel display mode, a user can double tap on certain channel to change to 1CH display mode.

- Tap “**PTZ**” to enable PTZ function. Please refer to **10.1.7 PTZ Control** for more detail.
- Tap “**OSD**” to remove Camera Name and Date/Time from OSD.
- Tap “**Audio on**” to enable audio or Tap “**Audio off**” to disable audio. (1CH display ONLY)
- Tap “**Playback**” to switch from Live mode to Playback mode.
- To use Zoom feature, simply pinch and drag in 1CH display. (1CH display ONLY)

NOTE







Audio, Zoom and PTZ are available only in full screen mode.(1channel only)

NOTE

If a user enable frame skip, used memories will be stable and It's possible to use it on live mode and playback mode.

10.1.6 Live View (Landscape View)



- To select other channels,
 - Slide finger from Right to Left to ascend. (1 → 2 → 3 14 → 15 → 16)
 - Slide finger from Left to Right to descend. (16 → 15 → 14 3 → 2 → 1)
- Tap “**Back**” to go back to main menu.
- Tap “   ” to choose split mode between 1, 4, 9 and 16.
 - In Multi-channel display mode, user can double tap on certain channel to change to 1CH display mode.
- Tap “**PTZ**” to enable PTZ function. Please refer to **10.1.7 PTZ Control** for more detail.
- Tap “**Audio**” to enable audio or Tap “” to disable audio. (1CH display ONLY)
- Tap “” to take Snapshot.
- To use Zoom feature, simply pinch and drag in 1CH display. (1CH display ONLY)



NOTE

Audio, Zoom and PTZ are available only in full screen mode. (1channel only)

10.1.7 PTZ Control

- Users are able to control PTZ with iPhone or iPad by touching the screen.
- Tap “**PTZ**” or “” to execute PTZ function.



- Tap Arrow for Pan and Tilt movement.
- Touch “” to zoom out.
- Touch “” to zoom in.
- If users already set up the presets on DVR, users may use them by touching “**P1 P2 P3**”.

10.1.8 Search

- Users are able to search the recorded data with iPhone or iPad
- Tap “**PLAYBACK**” on Main menu or “**Playback**” on Live monitoring to use search function.
- Choose date that wish to search from Calendar



- Choose time to search by sliding the Hour and Minute bar.
- Tap “**Search**” to execute search.



- To select other channels,
 - Slide finger from Right to Left to ascend. (1 → 2 → 3 14 → 15 → 16)
 - Slide finger from Left to Right to descend. (16 → 15 → 14 3 → 2 → 1)
- Tap “**1 channel**”, “**4 channels**”, “**9 channels**”, “**16 channels**” or “”, “”, “”, “” to choose split mode between 1, 4, 9 and 16.
 - In Multi-channel display mode, user can double tap on certain channel to change to 1CH display mode.
- Tap “”, “”, “”, “”, “” or “”, “”, “”, “”, “” to control the playback.
- Tap “” or “” to take Snapshot.
- Tap “**OSD**” to remove Camera Name and Date/Time from OSD.
- Tap “**Live**” to switch from Live mode to Playback mode.
- Tap “**Audio on**” or “” to enable audio. (1CH display ONLY)
- Tap “**Audio off**” or “” to disable audio. (1CH display ONLY)
- To use Zoom feature, simply pinch and drag in 1CH display. (1CH display ONLY)



NOTE

Audio, Zoom and PTZ are available only in full screen mode. (1channel only)

10.1.9 Snapshot gallery

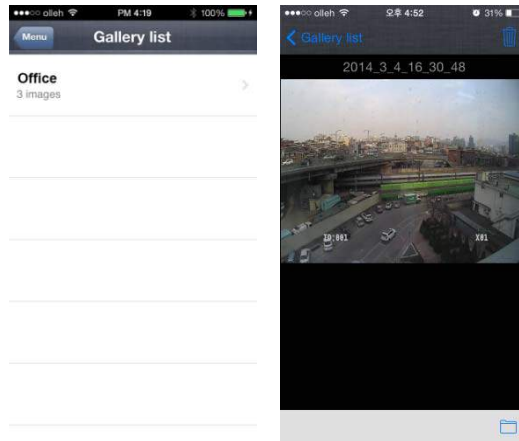
- Users are able to save the snapshot taken with mViewer pro while live monitoring and Playback.
- Tap “Snapshot gallery” from main menu.



- To see other pictures slide finger across the screen.
- Tap “” to send the snapshot to the Photos.
- Tap “” to delete the selected snapshot.

10.1.10 Setting

- Tap “**SETTING**” to check the information of the application.
- A user can read the manual.



10.1.11 Uninstallation

- In order to uninstall application, tap the "  " icon and hold for a while until the program icon shows "x" mark then click "x"

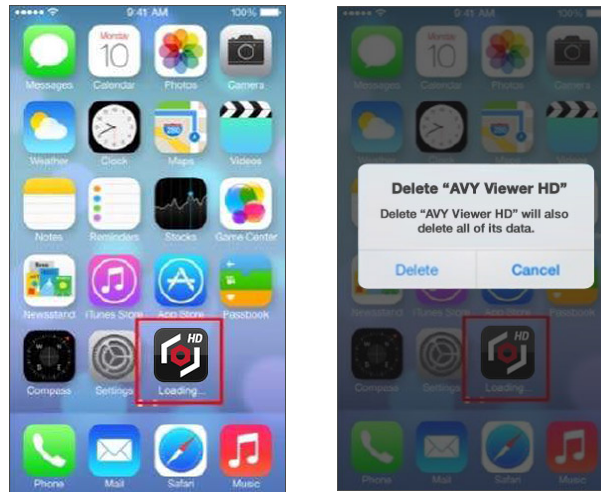

10.2 Android Phone (AVY Viewer HD)

10.2.1 System Requirements

- This program is designed and applied only for Android OS (version 2.3 or higher) based mobile device.
- Display: Min. 3.7 inch screen

NOTE

AVY Viewer HD might not work even though Android OS version is high enough. It is due to the hardware specification of Android device.

10.2.2 Installation

- Turn on the mobile device then connect to Play Store.
- Move to search menu and type "AVY Viewer HD" then select "  " program which is offered from dvrdomain for free.

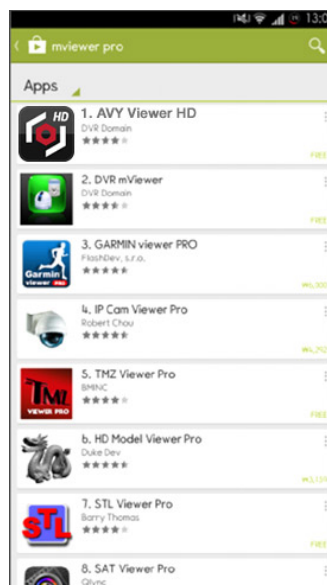

- Tap “  ” to start installation.

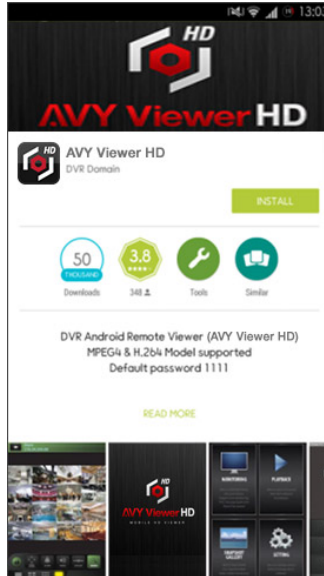

- When Access popup is display, please tap “

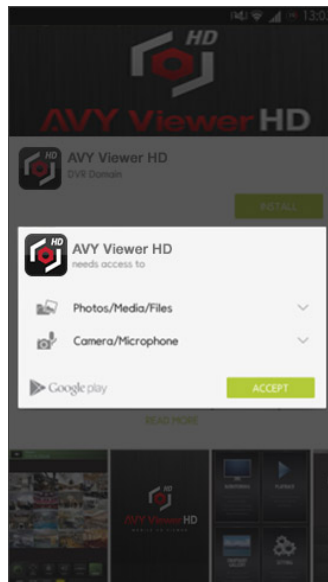



10.2.3 Site Registration

- Tap “  ” icon on application menu then below will show.

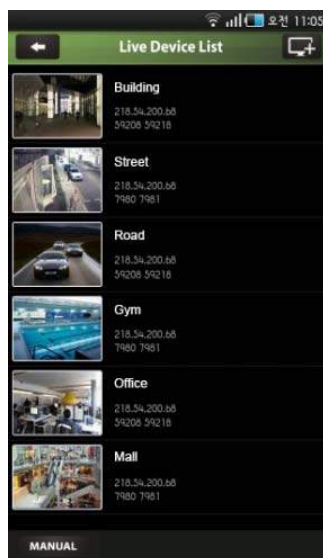

- Tap “**MONITORING**” on the main menu and tap “” on top right corner.



- Enter Device Name, IP/Host address.
- Enter Cmd/Stream port value. (Default, 5920/5921)
- Enter User ID/Password. (Default, admin/1111)
- Tap “” to save the setting.
- To edit or delete the saved site, press the Device Name for 2 sec from Live Device List and popup menu will display.

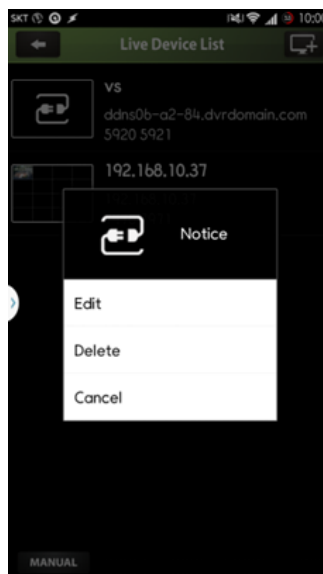





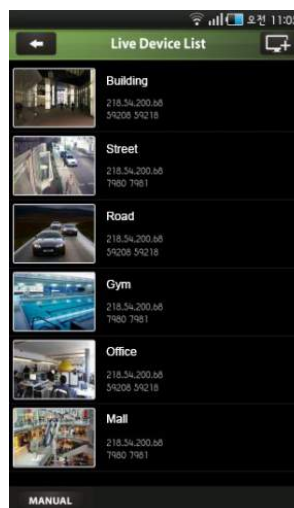





10.2.4 Connection

- Tap on Device Name to connect the DVR to mobile device.





10.2.5 Live View (Portrait View)



- To select other channels,
 - Slide finger from Right to Left to ascend. (1 → 2 → 3 14 → 15 → 16)
 - Slide finger from Left to Right to descend. (16 → 15 → 14 3 → 2 → 1)
- Tap  to enable Landscape view when the device is tilted
- Tap  to enable Frame skip or Tap  to disable Frame skip.
- Tap  to enable PTZ function. Please refer to **10.2.7 PTZ Control** for more detail.
- Tap  to enable Alarm Out control. Please refer to **10.2.8 Alarm Out Control** for more detail.
- Tap  to enable audio or Tap  to disable audio
- Tap  to change to other Device if there is any.
- Tap  to switch to Search mode.
- Tap on  or  to choose split mode between 1, 4, 9 and 16.



- In Multi-channel display mode, a user can double tap on certain channel to change to 1CH display mode.
- Tap  to take Snapshot.
 - Enter file name and press  to save the image.
- Tap  to remove Camera Name and Date/Time from OSD.
- To use Zoom feature, simply pinch and drag in 1CH display. (1CH display ONLY) “

NOTE

Audio, Zoom and PTZ are available only in full screen mode.(1channel only)

NOTE

“Video Stream” does not apply when the dual streaming is on in the device.

NOTE

“Video Stream” cannot be applied to some old models. Please keep your device with the latest firmware version.





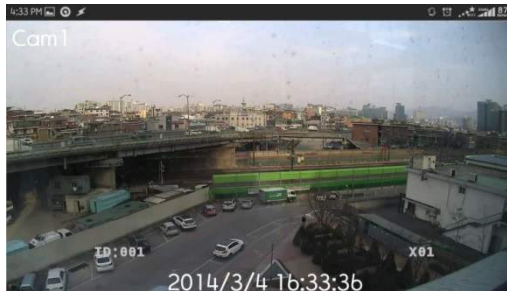





1.2.6 Live view (Landscape View)

- Tap “” to enable landscape view when the device is tilted horizontally.



- Tap screen once and menu bar will display on each side of OSD.



- To select other channels,
 - Slide finger from Right to Left to ascend. (1 → 2 → 3 14 → 15 → 16)
 - Slide finger from Left to Right to descend. (16 → 15 → 14 3 → 2 → 1)
- Tap on “   ” to choose split mode between 1, 4, 9 and 16.
 - In Multi-channel display mode, a user can double tap on certain channel to change to 1CH display mode.
- Tap “” or “” to select video steam.
 - Select “Low” for better transmission on Live and Playback mode
 - Select “High” to see original quality video in 1ch on Live mode
- Tap “” to enable PTZ function. Please refer to **10.2.7 PTZ Control** for more detail.
- Tap “” to enable audio.
- Tap “” to remove Camera Name and Date/Time from OSD.
- Tap “” to take Snapshot.
 - Enter file name and press “” to save the image.
- To use Zoom feature, simply pinch and drag in 1CH display. (1CH display ONLY)

NOTE

Audio, Zoom and PTZ are available only in full screen mode.(1channel only)

NOTE

“Video Stream” does not apply when the dual streaming is on in the device.

NOTE

“Video Stream” cannot be applied to some old models. Please keep your device with the latest firmware version.

10.2.7 PTZ control

- Users are able to control PTZ with mobile device by touching the screen.

- Tap “PTZ” or “PTZ” to execute PTZ function.



- Tap Arrow for Pan and Tilt movement.

- Touch “⊖” to zoom out.

- Touch “⊕” to zoom in.

- If users already set up the presets on DVR, users may use them by touching “P1 P2 P3”.

10.2.8 Alarm Out Control

- Users are able to manually send Alarm out command with the mobile device.

- Tap “ALARM” to enable the Alarm Out control and it will display on lower left corner of Live screen.



- Tap the numbers to send out Alarm from the connected DVR to its output source.

10.2.9 Search





- Users are able to search the recorded data with mobile device.

- Tap “PLAYBACK” on main menu or “SEARCH” on Live monitoring to use search function.

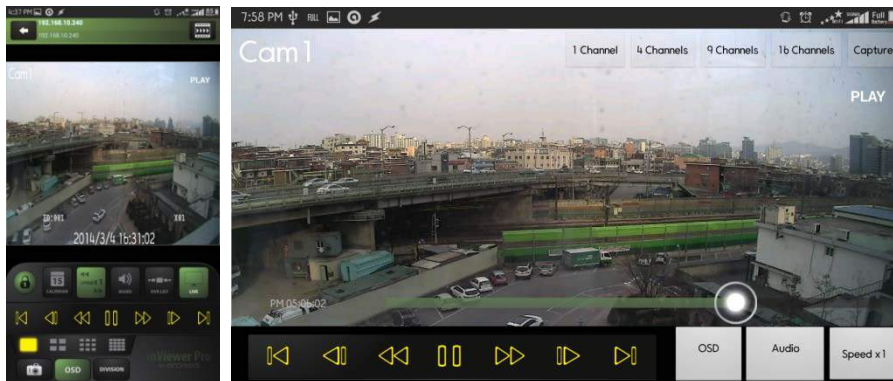

- Choose date and time that wish to search from Calendar and tap “  ” to execute search.



- To select other channels,
 - Slide finger from Right to Left to ascend. (1 → 2 → 3 14 → 15 → 16)
 - Slide finger from Left to Right to descend. (16 → 15 → 14 3 → 2 → 1)
- Tap “  ” to enable Frame skip or Tap “  ” to disable Frame skip.
- Tap “  ” or “  ” or “  ” to choose split mode between 1, 4, 9 and 16.
 - In Multi-channel display mode, user can double tap on certain channel to change to 1CH display mode.
- Tap “  ” to control the playback.
- Tap “  ” to enable Landscape view when the device is tilted.
- Tap “  ” to change date/time of Search.
- Tap “  ” or “  ” to enable select FF and REW speed from x1, x2, x4, x8, x16 and Extreme.
- Tap “  ” or “  ” to enable audio. (1CH display ONLY)
- Tap “  ” or “  ” to disable audio. (1CH display ONLY)
- Tap “  ” to change to other Device if there is any.
- Tap “  ” to switch to Live mode.
- Tap “  ” or “  ” to take Snapshot.
 - Enter file name and press “  ” to save the image.
- Tap “  ” or “  ” to remove Camera Name and Date/Time from OSD.
- To use Zoom feature, simply pinch and drag in 1CH display. (1CH display ONLY)

NOTE
 Audio and Alarm Out are available only in full screen mode.(1channel only)

10.2.10 Snapshot Gallery

- Users are able to watch snapshot with the mobile device.

- Tap **“SNAPSHOT GALLERY”** on main menu to enter the gallery.

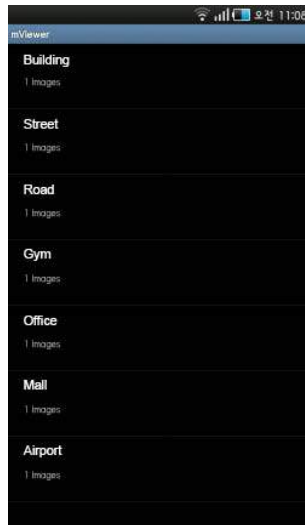

- Tap Device name to view snapshot.
- To see other pictures, slide finger across the screen or touch the thumbnail below.
- To delete the picture/folder,
 - Press the device name for 2-3 seconds till pop-up window appears.
 - Tap “OK” to delete.

10.2.11 Setting

- Tap **“SETTING”** to check the information of the application.
- A user can read the manual.
- Users are able to set Password Lock.
 - Tap “Password Lock” from the setting menu.
 - Enter password. (Default password is 1111)

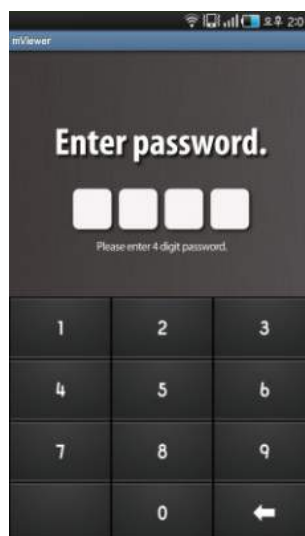

- Tap to enable Password Lock when launching the **AVY Viewer HD**.

- Tap **“change”** to change the password.

10.2.12 Uninstallation

- Move to Setup > Application > Manage Applications then select “

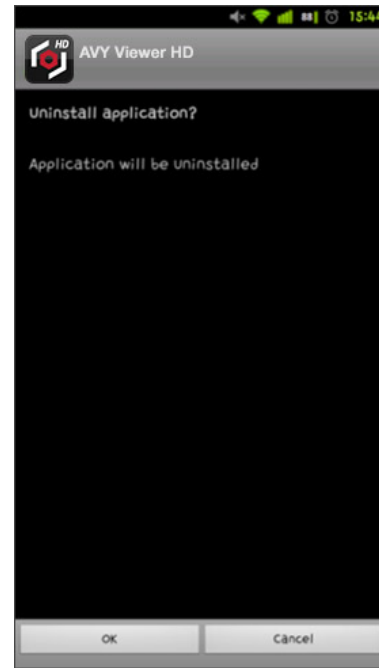

- Tap “

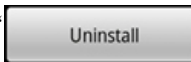

” icon then it will ask to delete the program.

**Keyboard Controller
AVK-P2500**

User`s Manual



11. KEYBOARD CONTROLLER (AVK-P2500)

11.1 Connection

- A user may connect cameras and Keyboard to a DVR.
- Please see below for connection examples. RS485 ports are used for connections.

11.1.1 Configuration Diagram

- Example

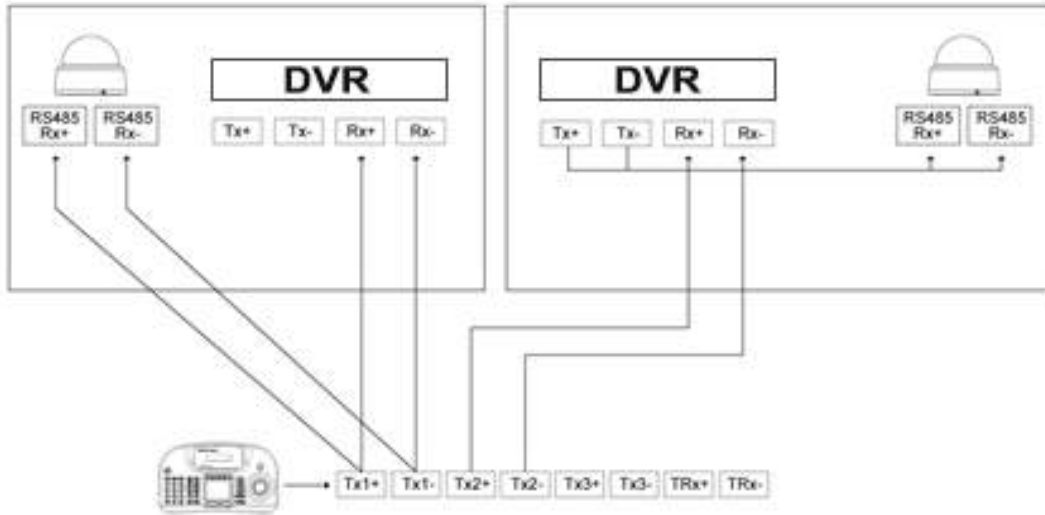

- Please make sure to connect “Tx to Rx” or “Rx to Tx” with same polarity. (+ to +) and (- to -).

11.1.2 USB Connection

- In order to use Touch Pad on AVK-P2500, a user should connect AVK-P2500 and DVR with provided USB cable.
- DVR will automatically recognize the Touch Pad.

11.2 Keyboard Setup in DVR

- Enter “Setup>SYSTEM>General>Setup” and define the ID of DVR.
- When a user connects more than two DVRs then each DVR has to have a different ID.

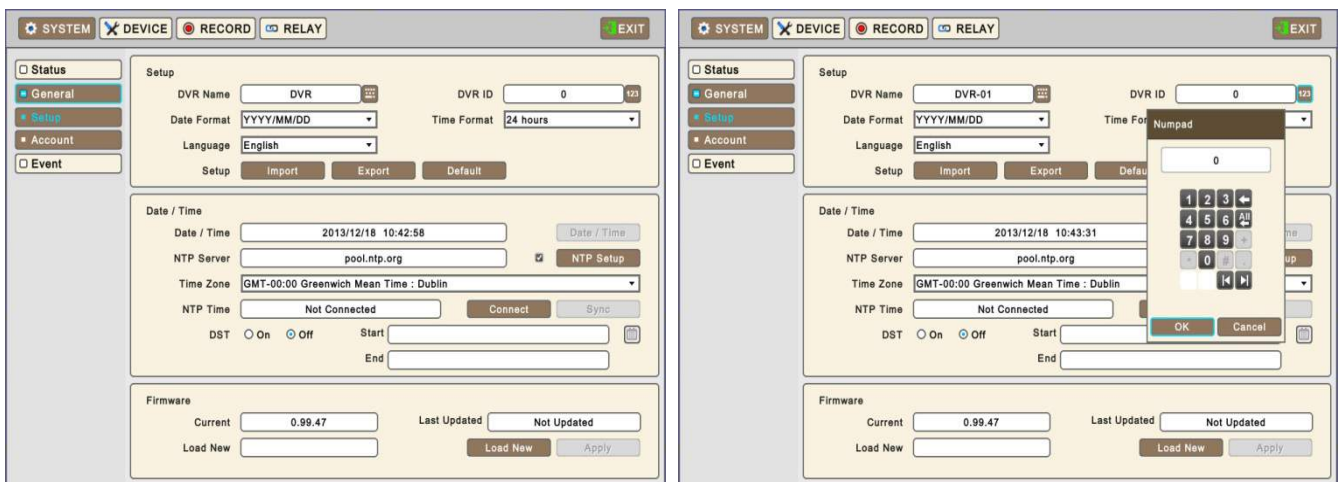

- Then move to “Setup>Device>Camera” and select AVK-P2500.
- Then, choose PTZ protocol and Camera ID. (For detailed information on setting PTZ camera, please refer to DVR manual)

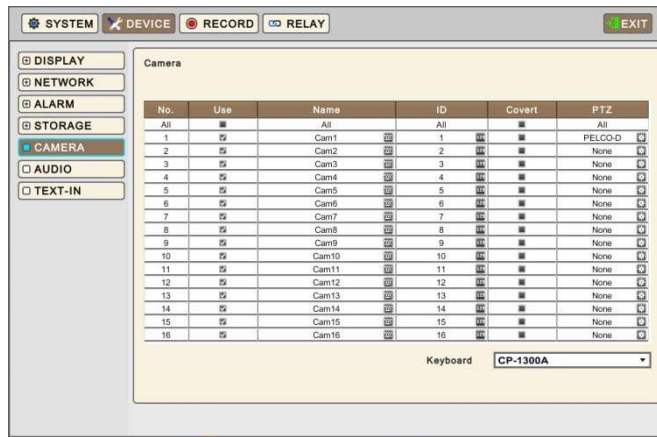

11.3 Keyboard Configuration

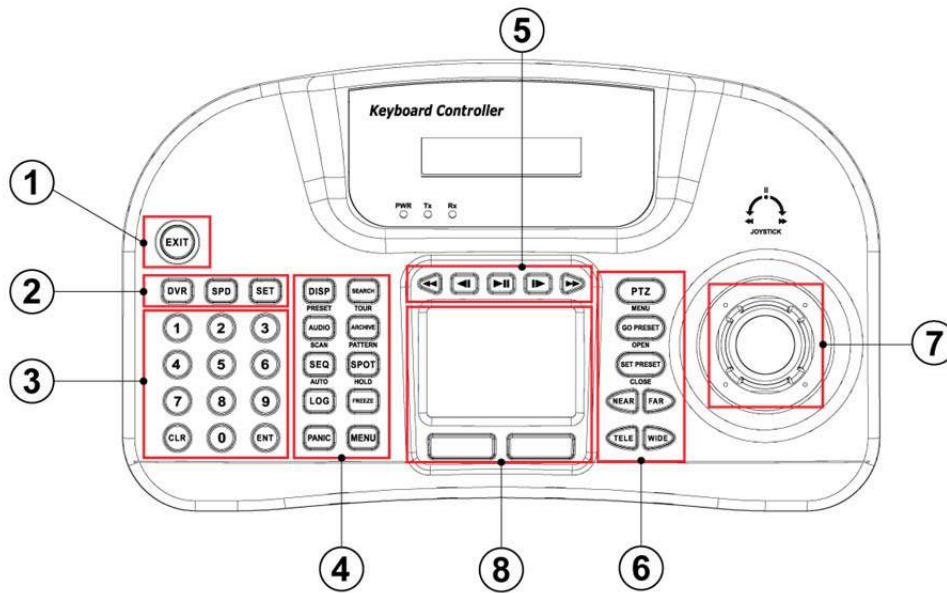

	KEYS	DVR Mode		SPD mode
		DVR control Mode	PTZ Mode	
①	EXIT	EXIT Key	N/A	N/A
②	DVR	DVR Mode select Key		
	SPD	SPD Mode select Key		
	SET	Setup Key		
③	0 ~ 9	Number Pad Key		
	CLR	Clear Key		
	ENT	ENTER Key		
④	DISP (PRESET)	Display Key	N/A	Preset Key
	AUDIO (SCAN)	Audio Key	N/A	Scan Key
	SEQ (AUTO)	Sequence Key	N/A	Auto Key

		System Log Key	N/A	N/A
		Emergency recording Key	N/A	N/A
	 (TOUR)	Search Key	N/A	Activate Tour Key
	 (PATTERN)	Archive Key	N/A	Activate Pattern Key
	 (HOLD)	Spot control Key	N/A	Hold Key
		Pause on Live Key	N/A	N/A
		DVR Menu Key	N/A	N/A
⑤		REW Key	N/A	N/A
		Backward Key	N/A	N/A
		Play/Pause Key	N/A	N/A
		Forward Key	N/A	N/A
		FF Key	NA	N/A
⑥	 (MENU)	PTZ Mode Key	N/A	Camera Menu Key
	 (OPEN)	N/A	Activate Preset Key	Open Iris Key
	 (CLOSE)	N/A	Set Preset Key	Close Iris Key
	 	N/A	Focus control Key	Focus control Key
	 	N/A	Zoom control Key	Zoom control Key
⑦	JOYSTICK	Direction key	Pan, Tilt, Zoom	
⑧	Touch Pad	Mouse	N/A	

11.4 Setup

11.4.1 DVR Control Mode

- Press **1** + **SET** in DVR Mode to enter Main Setup and enter password. (Default password is 0000)

Keyboard	Detail	Option
VER	Firmware version	-
DATE	Date setting	YY/MM/DD
TITLE SET	Camera title	-
CONTROL ID	ID No. Change	-
DVR SPD	Set Baud rate	2.4Kbps~57.6Kbps
COMM	Communication setting	RS422 / RS485
BACKLIGHT	Backlight setting for LCD	OFF / ON / AUTO
SLEEP	Sleep mode setting	OFF / 1Min / 5Min / 10Min / 30Min / 1 Hr
BUZZER	Buzzer setting	OFF / ON
TERMINATE	Termination	OFF / ON
JOYSTICK SPD	Joystick speed	50MS~300MS
PASSWORD	Change password	Default password: 0000
FACTORY SET	Factory reset	-
SAVE/EXIT	Save and Exit	NO / YES

11.4.2 Speed Dome Setup

- Press **2** + **SET** in SPD Mode to enter Speed Dome Setup and enter password. (Default password is 0000)

Keyboard	Detail	Option
ADDRESS	Camera ID number	1~255
MODEL	Select Camera	-
PROTOCOL	Set Protocol	PEL-D / PEL-P / W-DRX / SAM-E / LGP / SAM-T / PANAS / VICON / AD / HWELL
BAUDRATE	Set Baud rate	2.4Kbps~57.6Kbps
PARITY	Set Parity	NONE / EVEN / ODD
PROP	Set Camera speed	Slow PTZ => PROP: ON Speed PTZ => PROP: OFF

11.4.3 Joystick Calibration

- Press **3** + **SET** to enter Joystick Calibration and enter password. (Default password is 0000)

Keyboard	Detail	Option
PTZ OFFSET	Rest position value setting	-
PAN LEFT	Left Pan value setting	-
PAN RIGHT	Right Pan value setting	-
TILT UP	Tilt Up value setting	-
TILT DOWN	Tilt Down value setting	-
ZOOM WIDE	Zoom Wide value setting	-
ZOOM TELE	Zoom Tele value setting	-

11.5 Operation

11.5.1 DVR/SPD Mode Conversion

- Press “System ID” + “DVR” to enter DVR control Mode.
- Press “Speed Dome Camera ID” + “SPD” to enter PTZ camera control Mode.

Example

- If a user wishes to connect to SYSTEM ID 3 DVR then press Num Pad “3” + “DVR”.
- If a user wishes to connect to Speed Dome camera ID 3 then press Num Pad “3” + “SPD”.

11.5.2 DVR Control Mode

11.5.2.1 Connection

- If the DVR Control Mode is selected followings will display on Keyboard LCD and Live OSD as “KBD: #” on the right-bottom corner.



- Then, a user should be able to operate the DVR functions by AVK-P2500.

11.5.2.2 Buttons

- In DVR control mode, all buttons are operated according to texts written on each button. The functions are same as Front buttons of DVR as follows:

- **DISP** : Change display mode on Live and Playback in sequence of 1CH>4CH>9CH>16CH>1CH.
- **AUDIO** : Activates and the AUDIO function and change Audio channel
- **SEQ** : Turn on/off Sequence function. Only supports 1CH, 4CH, 9Ch display mode
- **LOG** : Pop up System Log
- **PANIC** : Active Emergency recording.
- **SEARCH** : Pop up Search Menu in Live or switches to Live in Playback mode.
- **ARCHIVE** : Pop up Archive window.
- **SPOT** : Change the channel of a monitor connected to the Spot output.
- **FREEZE** : Freeze a current image in Live mode ONLY.
- **MENU** : Pop up Setup window.
- **PTZ** : Enter PTZ control mode and able to use PTZ function of DVR.

- , , , ,  : Playback control in DVR Search Mode.

-  : View a channel in full screen (by selecting a number with ENTER button).

NOTE

• For detailed information on PTZ Mode, please refer to **4.3.5 Camera**.

11.5.2.3 PTZ Mode

• In order to enter PTZ mode, press “Camera ID” + .

NOTE







• PTZ Mode only can be switched from DVR Mode.

• If the PTZ Mode is selected following will display on Keyboard LCD and OSD



• Then, a user should be able to operate the PTZ camera with AVK-P2500.

• In PTZ mode, all buttons are operated according to texts written on each button. The functions are same as Front buttons of DVR as follows:

- # +  : will move to saved Preset point.
- # +  : will save new Preset point under #.
- Press   to adjust the Focus.
- Press   to activate the Zoom.

WARNING

• DEPENDING ON THE PROTOCOL BEING USED BY THE SPEED DOME CAMERA, CONTROLLING CAMERA MENU COULD BE DIFFERENT. PLEASE CHECK SPEED DOME CAMERA MANUAL.

11.5.3 SPD Control Mode (Speed Dome)

11.5.3.1 Connection

• If the SPD Control Mode is selected followings will display on Keyboard LCD:













- Then, a user should be able to operate the Speed Dome camera directly with AVK-P2500.

NOTE

- Please check Protocol and Baud rate before operating the Speed Dome Camera using AVK-P2500.

11.5.3.2 Buttons

-  (**PRESET**): Press number Key and PRESET then the camera will move to designated point.
-  (**PATTERN**): Press number Key and PATTERN then the designated Pattern will run
-  (**AUTO**): Press number Key and AUTO then the designated Auto will run.
-  (**TOUR**): Press number Key and TOUR then the designated Tour will run.
-  (**SCAN**): Press number Key and SCAN then the designated Scan will run.
-  (**HOLD**): Press HOLD to lock the Keyboard. To unlock a user has to input Password. (Default password is 0000)
-   : Press NEAR/FAR to adjust the focus of Speed Dome camera.
-   : Press TELE/WIDE to adjust the zoom of Speed Dome camera.

NOTE

- SPD Control Mode is only supported when Speed Dome Camera is directly connected to AVK-P2500.

WARNING

- DEPENDING ON THE PROTOCOL BEING USED BY THE SPEED DOME CAMERA, CONTROLLING CAMERA MENU COULD BE DIFFERENT. PLEASE CHECK SPEED DOME CAMERA MANUAL.

NOTE

- **When a Key does not Work after Set up**
 - If the communication speed of DVR and CP are not co-related, it may not work. Please make sure the Baud rate of Keyboard sets on 9.6kbps.
 - Press the button to enter PTZ mode and switch to DVR mode again.
 - Please reboot the DVR.
- **When Tx Blinks Continually on the LED Window**
 - If Tx blinks continually without any operation, it may be caused by improper set up of Joystick.
 - OFFSET of the Joystick may not appropriately set up.
 - Please do Joystick calibration.

TEXT-IN (POS)

User`s Manual

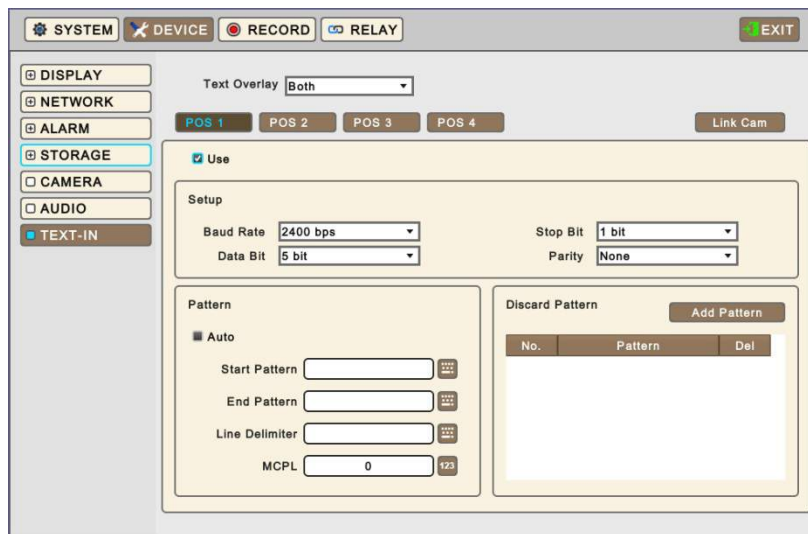

12. TEXT-IN (POS)

12.1 Usage of Serial-In Function

- Enables a user may use Serial In connections to record/search/display text data from POS/Cash Register's serial.
- A user can choose the data whether to record/display or both.

12.2 Connection Method

- Up to four ATM/POS channels are available could be connected.
- A DVR uses a USB port for Serial In to connect to a POS/Cash Register. Use correct USB to RS232 converters as follows.
 - FTDI chipset included converter
 - Prolific PL2303 / PL2303X / PL2303HX chipset included converter
 - Winchiphead chipset included converter
- When using a converter, please connect USB slot of DVR first, then restart in order to the DVR recognizes the USB converter as an RS-232 Serial In.
- When using a multi-converter, the port recognizes Serial In1 as its shortest line.

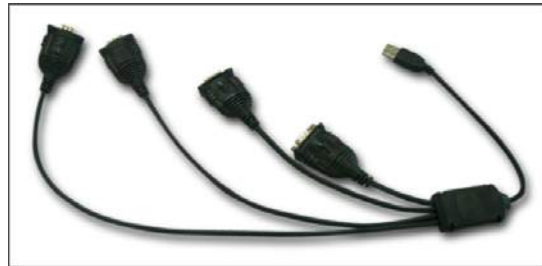
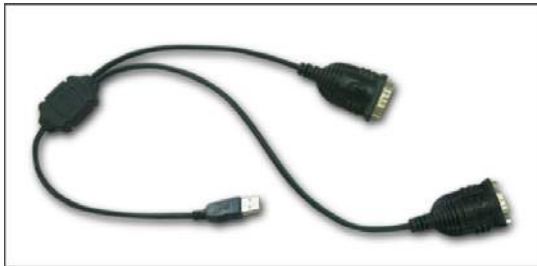

NOTE

A DVR can only recognize English alphanumeric characters.
The maximum extension length for RS-232 cable is 15 meters approximately with no signal loss.

12.3 Connection Diagram

- Users can connect RS-232 port to USB port at front/rear of DVR by using a converter.

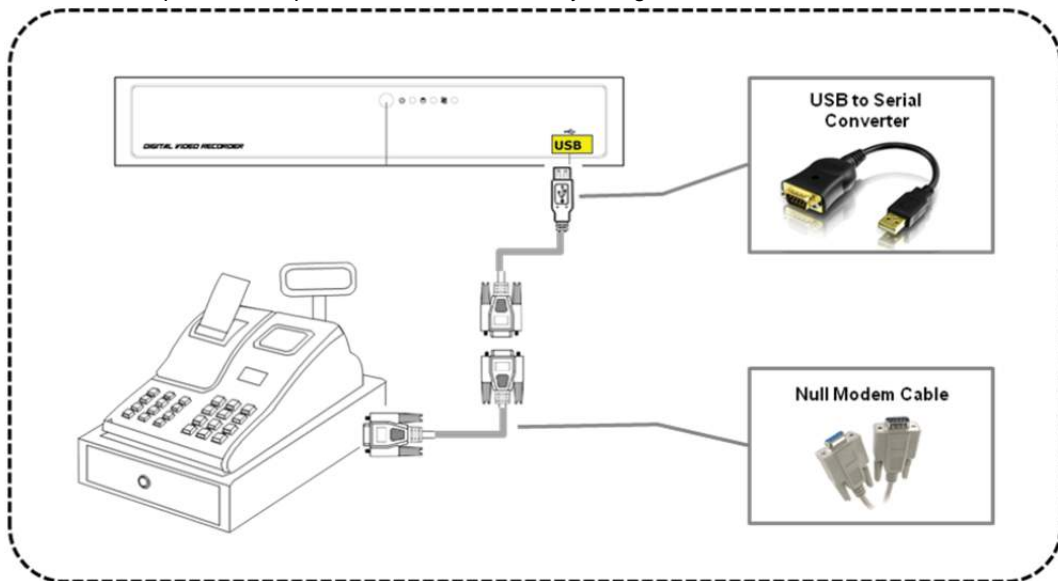

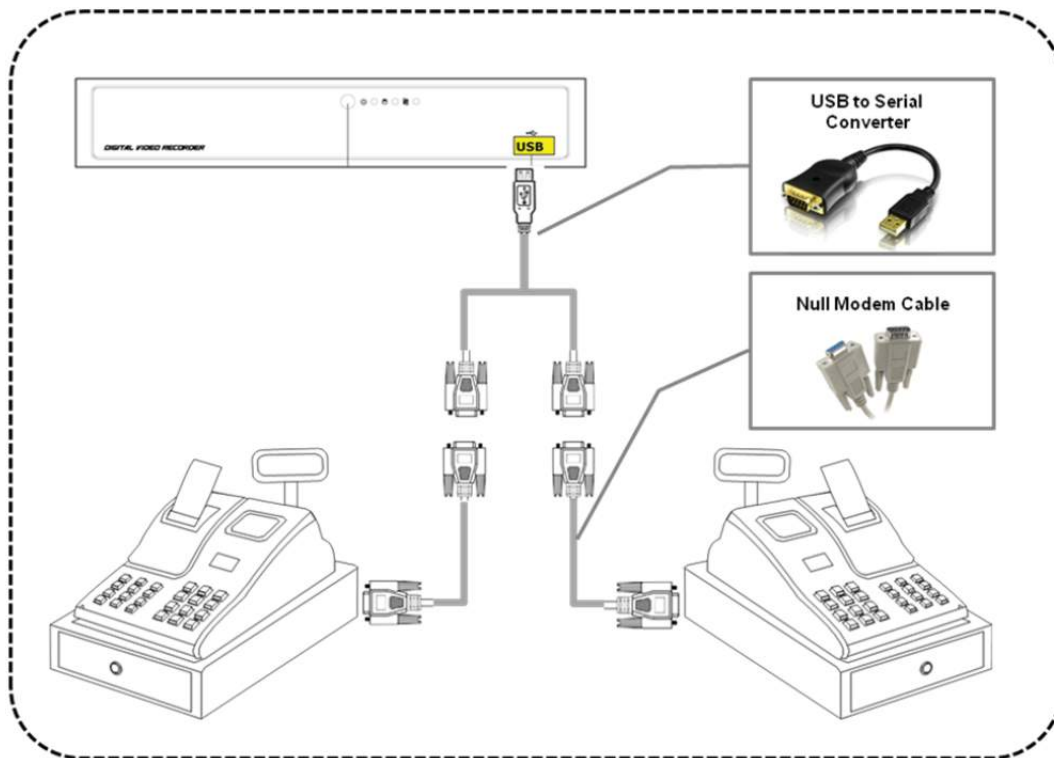

NOTE

- After cables connected and Serial In (DVR menu) values changed, please restart the DVR so that the DVR recognizes attached Serial In connections.
- Use RS232 null modem cable between POS/Cash Register and USB to RS232 converter. RS232 cross-over connector is useful when a user needs to switch the Rx/Tx connections.

Direct connection

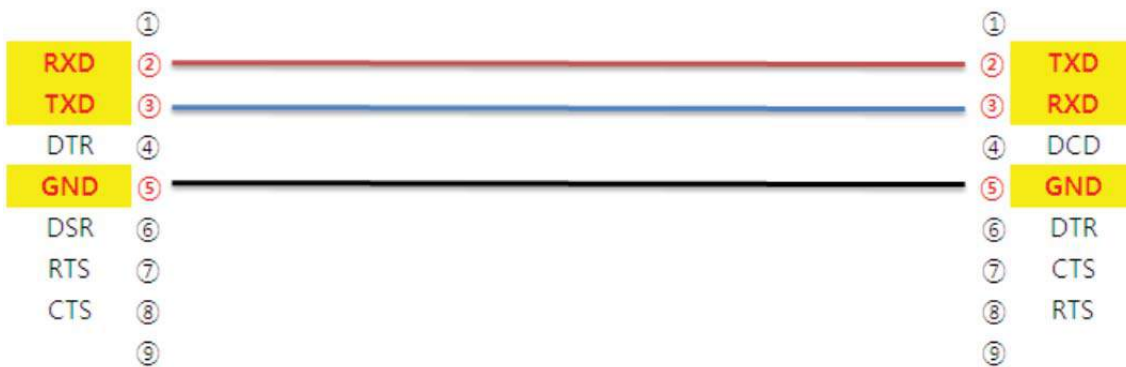

Cross connection[Null modem]

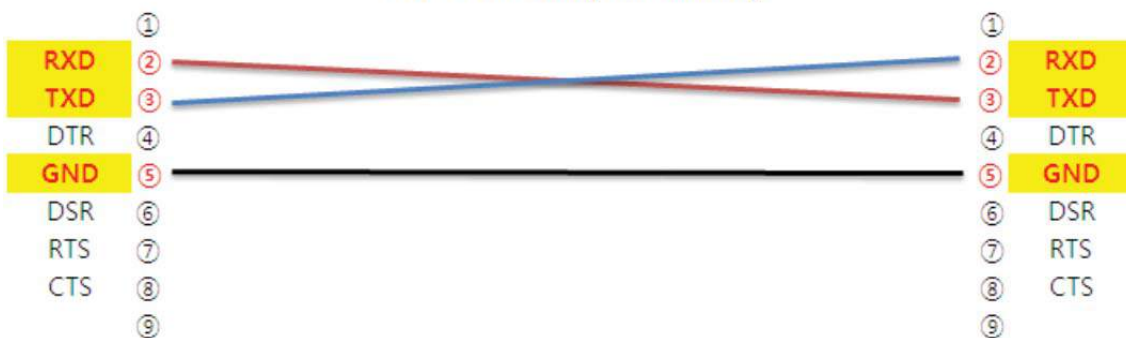

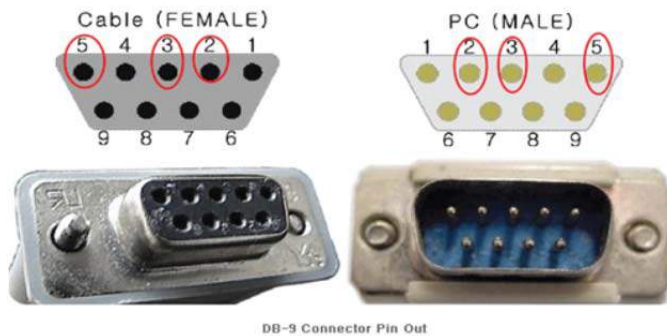

Pin Number	Signal	Info
1	CD	Carrier Detect
2	RXD	Receive Data
3	TXD	Transmit Data
4	DTR	Data Terminal Ready
5	GND	Signal Ground /Common
6	DSR	Data Set Ready
7	RTS	Request To send
8	CTS	Clear to send
9	RI	Ring indicator

12.4 Relay

12.4.1 Relay Setup (Optional)

- Click "Setup>Relay>TEXT-In" and the following screen will display.

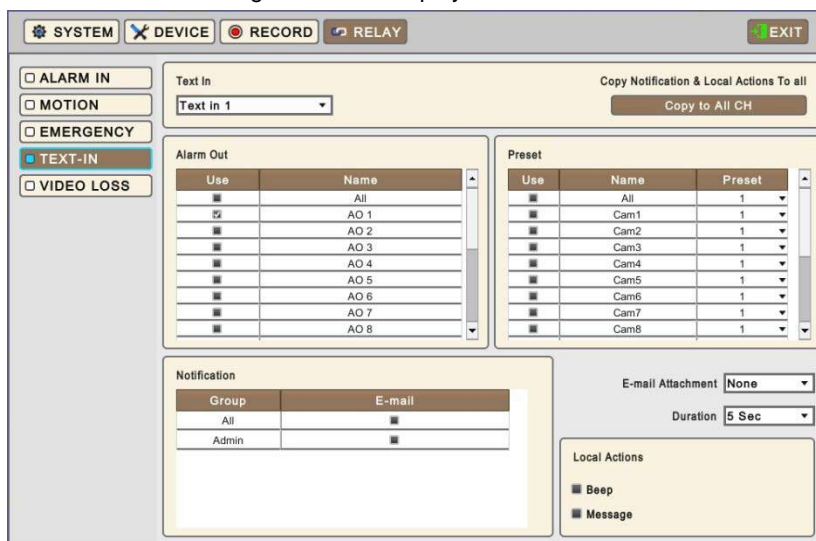

- Select cameras for Preset, Alarm Out and Notification while the Text In is operation, if necessary.
- Link Notification displays E-mail addresses registered in System>General>Account>User>Email
- Please follow the setup procedures below.
 - Click (←) Drop-down list of Text In box and select Text 1.
 - Select alarm outputs to be worked when Text In 1 is on. Please check a check box of use column on Alarm Out box. More than two alarm outputs can be set. If Click (←) 'All' of use box, all items are checked/unchecked at once.
 - Select cameras for preset when Text In 1 is on. Please check a check box of use column on Preset box. More than two cameras can be set. If Click (←) 'All' of use column, all items are checked/unchecked at once
 - Click (←) Drop-down list of Preset to change Cameras preset. If Click (←) Drop-down list of all preset column, all items are changed at once
 - Select group for notification when Text In 1 is on. Please check a check box of E-Mail column. More than two Groups can be set.
 - Click (←) Drop-down list of E-mail Attachment box to attach JPEG, EXE or None
 - Click (←) Drop-down list of Duration box to set the duration of recorded data for attached EXE
 - Select Local Actions
 - Beep: When Text In 1 is on, it will give the alarm sound
 - Message: When Text In 1 is on, the alarm message will pop up on the OSD
- Repeat the above procedure for Text In 2~ Text In 4
- Click (←) Copy to All CH button to copy Notification & Local Actions to all channels.

12.4.2 Schedule Setup (Mandatory)

- Click "Setup>Record>Schedule" then shows as below.

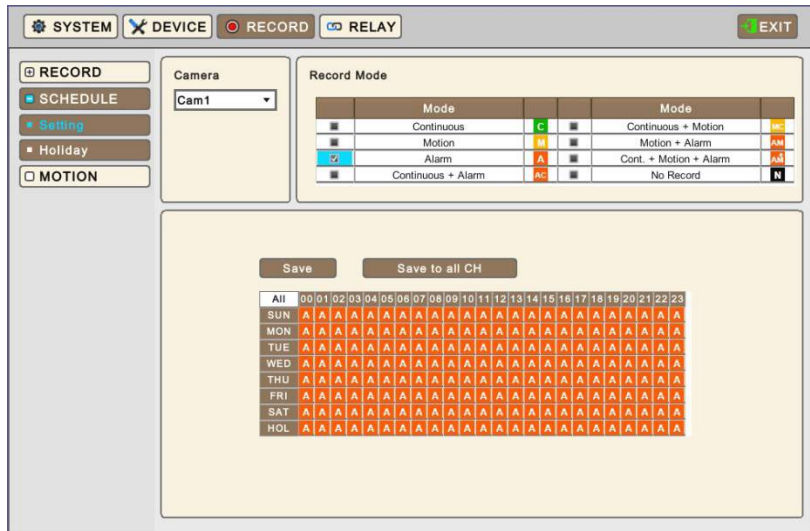

- Check the box (☐) item related to Alarm. 'Continuous + Alarm' is recommended
- Click the Time/Date that wishes to activate TEXT-IN function on schedule.
- Do the same for additional Text In channel.

12.5 Setup (Mandatory)

- Please Click (←) "Setup>Devices>TEXT-IN", then a user will see the display below.

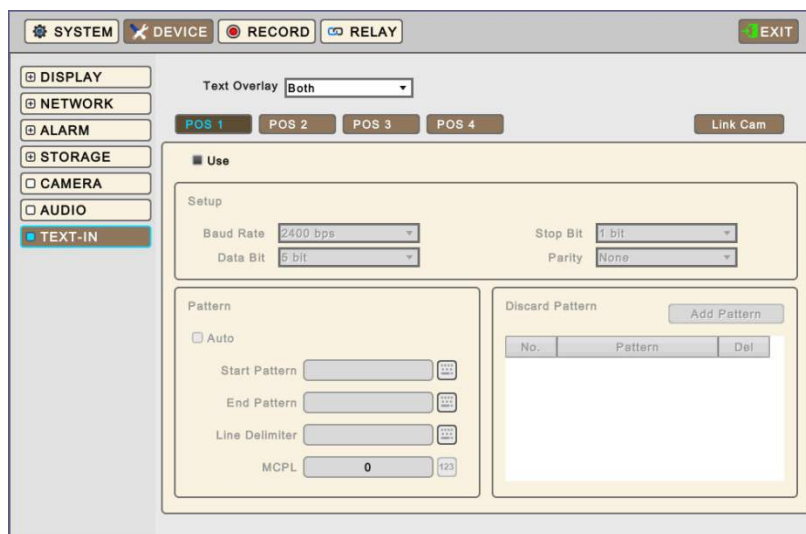

12.5.1 Text Overlay

- A user may choose whether to display the text inputs connected to the rs232 port on OSD screen.
- They have 4 menus as followings:
 - None: any displays on the OSD screen.
 - Live: displays incoming information from the serial port in real time on the OSD screen.
 - Record: displays the saved information on the OSD screen during replay.
 - Both: displays all the information on both Live and Playback mode.

12.5.2 Link Cam

- Click **Link Cam** and following screen will display.

Name	POS
Cam1	POS1
Cam2	POS2
Cam3	POS3
Cam4	POS4
Cam5	None
Cam6	None
Cam7	None
Cam8	None
Cam9	None
Cam10	None
Cam11	None
Cam12	None
Cam13	None
Cam14	None
Cam15	None
Cam16	None

- Link the POS1, 2, 3, 4 to any channel and it is possible to select more than one channel per POS device.

12.5.3 Device Setting

- Check the box next to 'Use' to activate the setting for POS device.

Setup

- Default values are Baud rate 2400 bps, Data Bit 5 bit, Stop Bit 1 bit, Parity None.
- Those values should match with the POS/Cash Register. Please refer to POS/Cash Register manual for exact values.

Pattern

- Check the "Auto" to automatically filter unnecessary data from POS/Cash Register. Additional filtering may also be required.
 - "Discard Pattern", "Line Delimiter" and "MCPL" are used with/without 'Auto' mode to get desired text inputs format.
- Start Pattern:** Indicates the beginning of the new data when new designated data are received from a serial device.
- End Pattern:** Indicates the end of the data when designated data are received from a serial device.
- Line Delimiter:** Inputs characters to be used as delimiter between lines.
- MCPL (Minimum Character Per Line):** Sets up the number of the minimum strings each line. Does not show the characters on OSD screen if there is a character of which number is below the designated number in each line divided by the line delimiter.

Discard Pattern

- Discard Pattern: Does not show the specified data on OSD screen. Sets up in order to designate dummy data or characters which is not to be displayed. Can be designated up to 33 of discard patterns in total.
- Press **Add Pattern** to add a pattern which does not need to be displayed/saved.
- To edit the saved discard pattern, press the pattern then virtual keyboard will display.
- To delete the saved discard pattern, Press 'x' next to each pattern.

12.5.4 Example

- When it firstly connected, the data will be displayed as below.



CAUTION

THE SCREEN MUST BE ON 1CH VIEW MODE TO SEE TEXT IN DATA.

- Input a certain repeated string to "Line Delimiter" like '[OD]' on the picture.

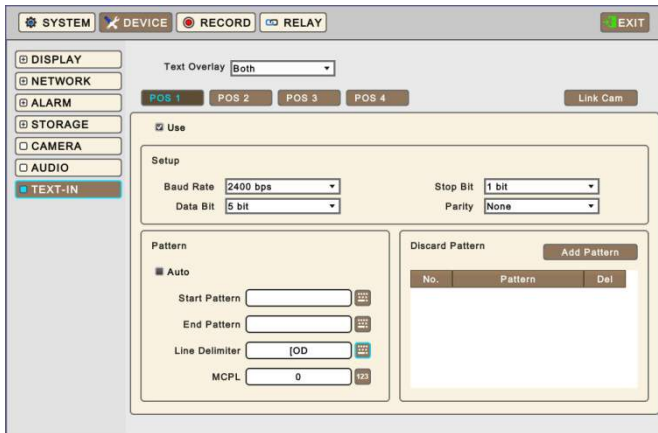

- Decide the number of minimum characters in "MCPL" item to hide data under the designated number of characters.

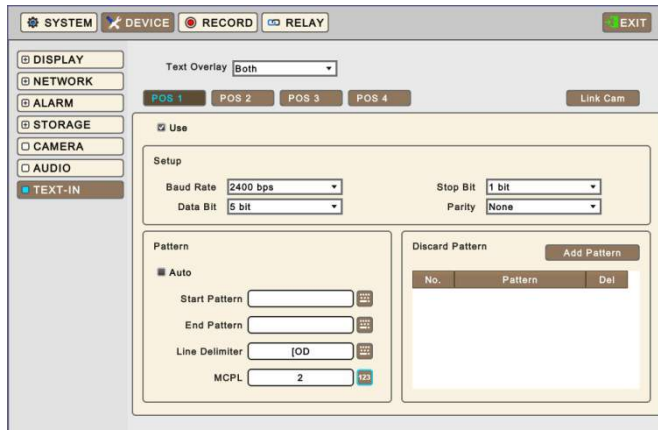

- Input the pattern of dummy data to Discard Pattern like '[3D]' on the picture.

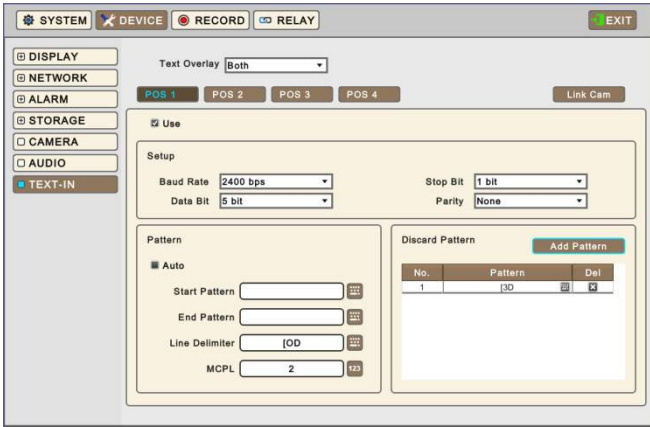

- Choose the data which willing to display and enter the Start Pattern and End Pattern.

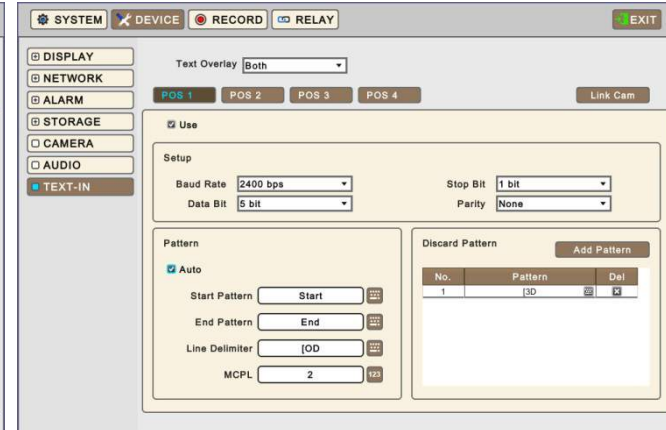
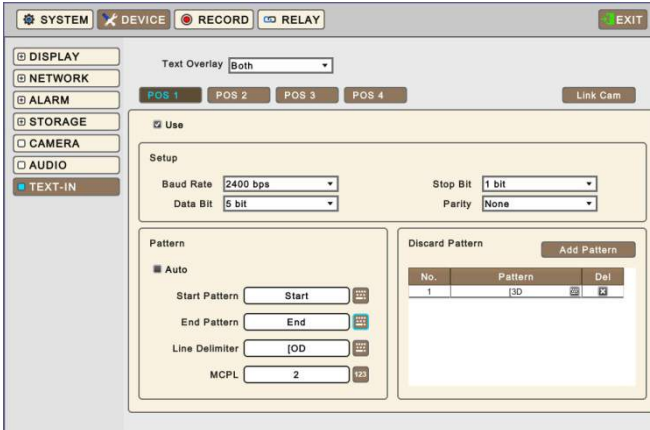

- Check or uncheck the 'Auto' box to see the differences. Depending on models of POS/Cash Register machines, it may give a better result or not.



- A user may need to repeat the processes to get the best result. Sometimes, checking the recorded data and pause the playback would be easier to verify.

12.6 Search

- TEXT-IN can be searched by keyword in Playback mode.

- Click (↔)  in the Playback mode, then a user will see the following screen.





- Please Click (↔)  to do Event Search and choose 'POS/ATM Search' then virtual keypad is display. Type a keyword to search by.
- Searched data will be listed.

**HD-SDI Video Signal
Accessories**

User`s Manual

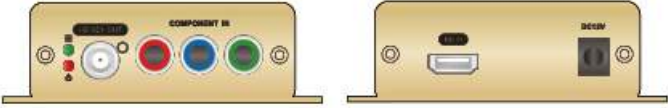
The List of Configuration

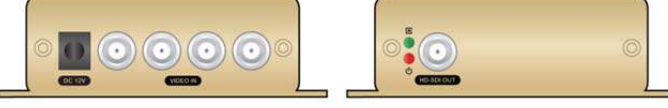
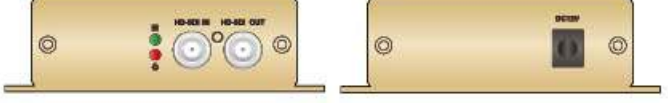
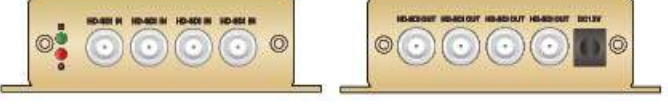
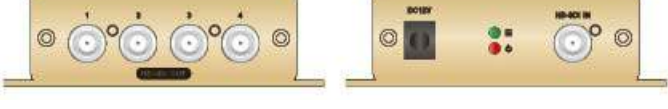
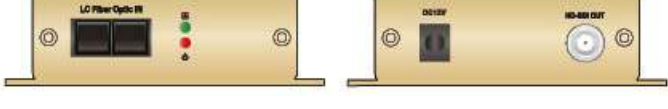
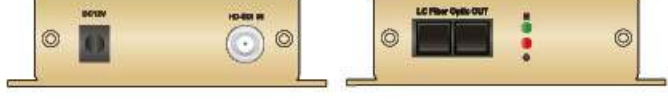
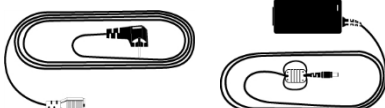
<p>HSC 1100 (HDMI to HD-SDI Converter)</p>	
<p>HSC 1200 (HD-SDI to HDMI Converter)</p>	
<p>HSC 2110 (1 to 1 Analog to HD-SDI Converter)</p>	
<p>HSC 2410 (4 to 1 Analog to HD-SDI Converter)</p>	
<p>HSR 1110 (1 In / 1 Out Repeater)</p>	
<p>HSR 1440 (4 In / 4 Out Repeater)</p>	
<p>HQS 1004 (1 In 4 Out Distributor)</p>	
<p>HFO 1100 (FO to HD-SDI Converter)</p>	
<p>HFO 1200 (HD-SDI to FO Converter)</p>	
<p>Power Adapter and Cable</p>	

13. HD-SDI Video Signal Accessories

13.1 HSC1100

13.1.1 Introduction

- HSC 1100 is an HD signal converter which converts video signal from HDMI to HD-SDI. It converts the high resolution of HDMI sources to SMPTE 292M, standard HD-SDI signal.

13.1.2 Features

- Convert HDMI to HD-SDI
- Convert HDMI and component input to HD-SDI SMPTE 292M
- Full HDMI Support Including Embedded Audio
- Equalized HDMI Input Supports Long HDMI Cables Up to 30m, 24 gauge
- HDMI v1.3 Standard
- HD-SDI SMPTE 292M Support(1080p, 1080i or 720p)
- Low Power Consumption: Free Voltage 12VDC, 1A
- Compact Size & Light Weight

13.1.3 Technical Specification

Model	HSC 1100
Input	HDMI Component Input
Input Formats	1080p 24/25/30 1080i 50/60 720p 50/60
Output	HD-SDI SMPTE 292M
Output Formats	1080p 24/25/30 1080i 50/60 720p 50/60
Power Consumption	Free Voltage 12VDC, 1A
Dimension (W*H*D)	83.75mm x 31.75mm x 87.07mm / 3.35inch x 1.27 x 3.48 inch
HDMI Connector	HDMI Female
HD-SDI Connector	BNC Female

13.1.4 Unpacking

- This equipment is an electronic appliance, so it should be handled with special care.

13.1.5 Service

- If there is any problem in the product, please contact the supplier or the distributor.

13.1.6 System Dimension Diagram

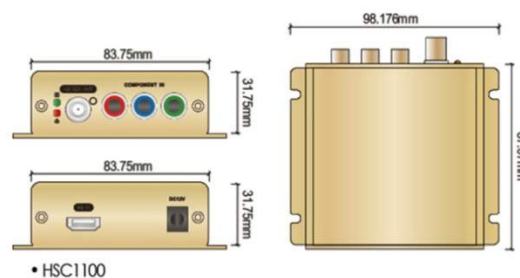

13.1.7 System Connection Diagram

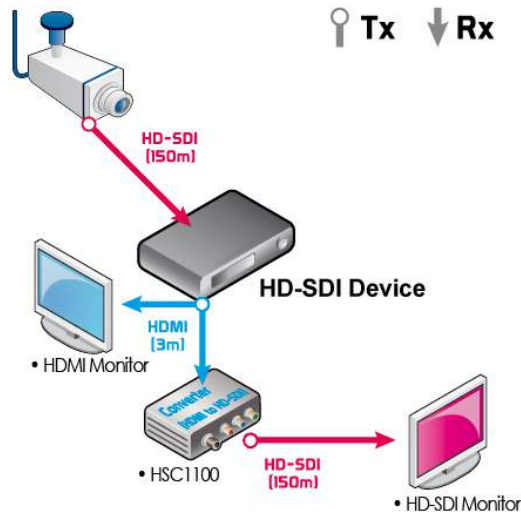

13.1.7.1 HDMI In/Out and HD-SDI In/Out Connections

- Connect an 'HDMI OUT' from a device to 'HDMI IN' of HSC 1100 using by HDMI cable.
- Connect an 'HD-SDI OUT' from HSC 1100 to 'HD-SDI IN' of HD-SDI device using by 75 ohm coaxial cable.

13.1.7.2 Video Component Input

- If users wish to link video component input (e.g. Divx, etc), assure that video component input and "COMPONENT IN" connections are connected properly with same colors.

13.1.7.3 Power Supply Connections

- Plug the power supply adapter (**DC 12V, 3.33A**) which is included in this product to 'DC12V' connector and plug another side to power source and Input voltage is a free volt (**100 VAC ~ 240 VAC**).

13.1.8 Cable





- 75 ohm coaxial cable
- HDMI cable
- Component cable

NOTE

The cables above are not included in the package.

13.1.9 Display

13.1.9.1 LEDs

KEYS		Operating mode
Power LED (Red)	 	<ul style="list-style-type: none"> • Light off: Converter off • Light on: Converter on
Connection LED (Green)	 	<ul style="list-style-type: none"> • Light off: Not connected • Light on: Connected

13.2 HSC1200

13.2.1 Introduction

- HSC 1200 is an HD signal converter which converts video signal from HD-SDI to HDMI.

13.2.2 Features

- Convert HD-SDI to HDMI
- Equalized HDMI input supports long HDMI cables up to 30m, 24 gauge
- HDMI v1.3 standard
- HD-SDI SMPTE 292M support(1080p, 1080i or 720p)
- Free voltage 12VDC, 1A
- Compact Size & Light weight

13.2.3 Technical Specification

Model	HSC 1200
Input	HD-SDI SMPTE 292M
Input Formats	1080p 24/25/30
	1080i 50/60
	720p 50/60
Output	HDMI
	HD-SDI Loop Output
Output Formats	1024 x 768
	720p 60
	1080p 30/60
Power Consumption	Free Voltage 12VDC, 1A
Dimension (W*H*D)	83.75mm x 31.75mm x 87.07mm / 3.35inch x 1.27 x 3.48 inch
HDMI Connector	HDMI Female
HD-SDI Connector	BNC Female

13.2.4 Unpacking

- This equipment is an electronic appliance, so it should be handled with special care.

13.2.5 Service

- If there is any problem in the product, please contact a supplier or a distributor.

13.2.6 System Dimension Diagram

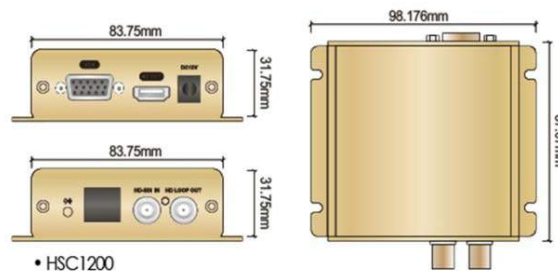

13.2.7 Connector Wiring



13.2.7.1 HD-SDI In/Out and HDMI In/Out Connections

- Connect an 'HD-SDI OUT' of HD-SDI device to 'HD-SDI IN' of HSC 1200 using by 75ohm coaxial cable.
- Connect an 'HDMI OUT' of HSC 1200 to 'HDMI IN' of device with HDMI output using by HDMI cable.

13.2.7.2 Power Supply Connections

- Plug the power supply adapter (DC 12V, 3.33A) which is included in this product to 'DC12V' connector and plug another side to power source and Input voltage is a free volt (100 VAC ~ 240 VAC).

13.2.8 Cable

- 75 ohm coaxial cable
- HDMI cable
- VGA cable

NOTE

The cables above are not included in the package.

13.2.9 Operation Key and Screen Display Information

First Digit No.	Output resolution
1	OUT_1024x768
2	OUT_1280x720p_60Hz
3	OUT_1920x1080_30Hz
4	OUT_1920x1080_60Hz, (default)
5	OUT_1920x1080_60Hz_RB

NOTE

Operation button: When operation button is pressed, output resolution is changed. Please refer the table above to identify signal output resolution on each button pressing.

Second Digit No.	Input resolution
-	No input detected
1	IN_1280x720p (max. 60 frames)
2	IN_1920x1080i(50 or 60 field)
3	IN_1920x1080p(30 frame only, doesn't support 60 frame)

NOTE

Input resolution depends on the input signal.

NOTE

Please note that HD-SDI Loop-out of this device has the same function as HD-SDI repeater that extends the signal transmission distance up to 150m.

13.3 HSC2110

13.3.1 Introduction

- HSC 2110 is a video signal converter from SD (Analog video signal) to HD-SDI.

13.3.2 Features

- Convert 1CH SD to 1CH HD-SDI
- NTSC/PAL Input Signal Auto Detection
- Output Signal Format 1080p 30

- Vertical Frequency Auto-Track
- PTZ control with Pelco C supporting PTZ camera
- Free Voltage 12VDC, 1A
- Compact Size & Light Weight

13.3.3 Technical Specification

Model	HSC 2110
Input Signal	Analog Input 75Ω, 1Vp-p/BNC-F, 1CH NTSC or PAL (Auto Detection)
Output Signal	HD-SDI SMPTE 292M
Output Format	1080p 30
Input Return Loss (BNC)	>-15dB, 270 Mb
Output Return Loss (BNC)	>-15dB, 1.5 Gb
Input Impedance (BNC)	75 Ohms +/- 1%
Output Impedance (BNC)	75 Ohms +/- 1%
Power Consumption	Free Voltage 12VDC, 1A
Dimension (W*H*D)	83.5mm x 31.5mm x 86.9mm
HD-SDI Connector	BNC Female

13.3.4 Unpacking

- This equipment is an electronic appliance, so it should be handled with special care.

13.3.5 Service

- If there is any problem in the product, please contact a supplier or a distributor.

13.3.6 System Dimension Diagram

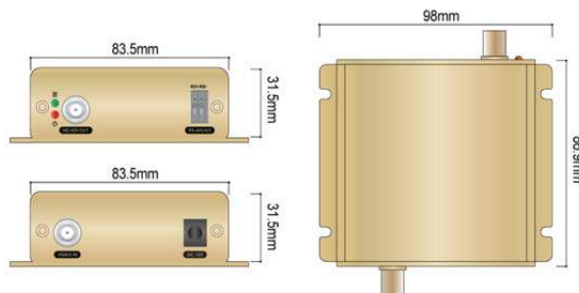

13.3.7 Connector Wiring



13.3.7.1 1 In / 1 Out Analog to HD-SDI Connection

- Connect a 'VIDEO OUT' of analog device to 'VIDEO IN' of HSC 2110 using 75ohm coaxial cable.
- Connect an 'HD-SDI OUT' of HSC 2110 to 'HD-SDI IN' of the HD-SDI DVR using 75ohm coaxial cable.



13.3.7.2 RS-485 Connection

- Connect 'Rx +/-' of the HD-SDI DVR or Keyboard Controller to 'Tx +/-' of HSC 2110.
- Connect 'VIDEO IN' of HSC 2110 to 'VIDEO OUT' of analog PTZ camera using 75ohm coaxial cable.

NOTE

This function is ONLY supported with PTZ camera which supports RS-485 over coax.

NOTE

Please refer to Product Manual 4.4.2 Camera / PTZ for more information.

NOTE

Only support Camera ID 1 in Camera / PTZ Menu.

13.3.7.3 Power Supply Connection

- Plug the power supply adapter (DC 12V, 3.33A) which is included in this product to 'DC12V' connector and plug another side to power source and Input voltage is a free volt (100 VAC ~ 240 VAC).

13.3.8 PTZ Control

- A user can control PTZ camera via DVR when connection between DVR, HSC2110 and Camera are properly done.
- For detailed information on Camera setup, please refer to **4.3.5 Camera**.

NOTE

This function is ONLY supported with PTZ camera which supports RS-485 over coax.

13.3.9 Cable





- 75 ohm coaxial cable
- RS-485 connection cable.

NOTE

The cable above is not included in the package.

13.3.10 Display

13.3.10.1 LEDs

KEYS	Operating mode
Power LED (Red)  	<ul style="list-style-type: none"> • Light off: Converter off • Light on: Converter on
Connection LED (Green)  	<ul style="list-style-type: none"> • Light off: Not connected • Light on: Connected

13.4 HSC2410

13.4.1 Introduction

- HSC 2410 is a video signal converter from SD (Analog video signal) to HD-SDI. It is 4 In / 1 Out SD to SDI signal converter which converts four analog signal to one HD-SDI signal.

13.4.2 Features

- Convert 4 of SD to 1CH HD-SDI
- NTSC/PAL Input Signal Auto Detection
- Output Signal Format 1080p 30
- Vertical Frequency Auto-Track
- Free Voltage 12VDC, 1A
- Compact Size & Light Weight

13.4.3 Technical Specification

Model	HSC 2410
Input Signal	Analog Input 75Ω, 1Vp-p/BNC-F, 4CH NTSC or PAL (Auto Detection)
Output Signal	HD-SDI SMPTE 292M
Output Format	1080p 30
Input Return Loss (BNC)	>-15dB, 270 Mb
Output Return Loss (BNC)	>-15dB, 1.5 Gb
Input Impedance (BNC)	75 Ohms +/- 1%
Output Impedance (BNC)	75 Ohms +/- 1%
Power Consumption	Free Voltage 12VDC, 1A
Dimension (W*H*D)	103mm x 31.5mm x 88.09mm
HD-SDI Connector	BNC Female

13.4.4 Unpacking

- This equipment is an electronic appliance, so it should be handled with special care.

13.4.5 Service

- If there is any problem in the product, please contact a supplier or a distributor.

13.4.6 System Dimension Diagram

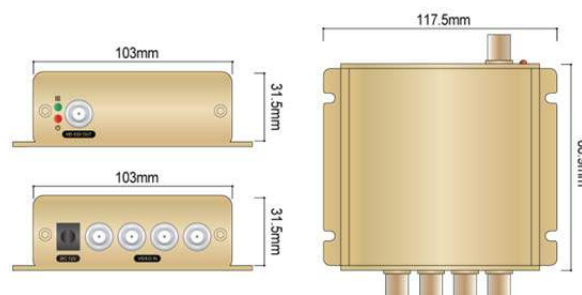

13.4.7 Connector Wiring

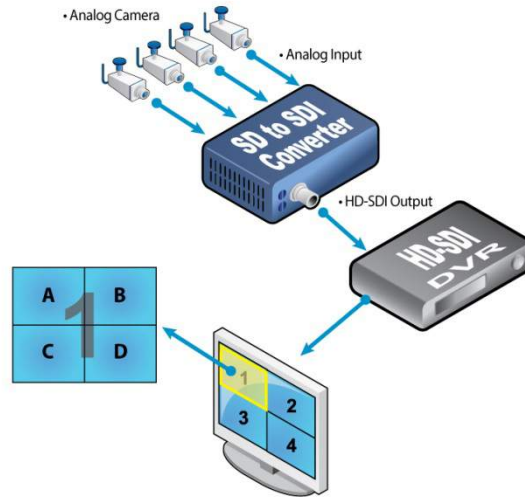

13.4.7.1 4 In / 1 Out Analog to HD-SDI Connection

- Connect 4 'VIDEO OUT' of Analog device to each of 4 'VIDEO IN' of HSC 2410 using 75ohm coaxial cables.
- Connect an 'HD-SDI OUT' of HSC 2410 to 'HD-SDI IN' of the HD-SDI DVR using 75ohm coaxial cable.

13.4.7.2 Power Supply Connection

- Plug the power supply adapter (DC 12V, 3.33A) which is included in this product to 'DC12V' connector and plug another side to power source and Input voltage is a free volt (100 VAC ~ 240 VAC).

13.4.8 Cable





- 75 ohm coaxial cable

NOTE

The cable above is not included in the package.

13.4.9 Display

13.4.9.1 LEDs

KEYS		Operating mode
Power LED (Red)	 	<ul style="list-style-type: none"> • Light off: Converter off • Light on: Converter on
Connection LED (Green)	 	<ul style="list-style-type: none"> • Light off: Not connected • Light on: Connected

13.5 HSR1110

13.5.1 Introduction

- HSR 1110 is an HD SDI repeater to extend the signal transmission distance between HD-SDI devices. The transmission distance is easily extended up to 150m and if it requires extending longer than 150m, it may connect another repeater to extend the signal transmission and it will be extended up to another 150m.

13.5.2 Features

- 1 in / 1 Out HD-SDI Repeater
- HD-SDI SMPTE 292M support(1080p, 1080i, or 720p)
- 150m Extension of transmission distance
- Vertical Frequency Auto-Track(60,60/1.001)

- Low Power Consumption: Free voltage 12VDC, 1A
- Compact Size & Light weight
- Input / Output return loss : >-15dB at 1.5GBPS
- Input / Output Impedance: 75Ohms+/-1%

13.5.3 Technical Specification

Model	HSR1110
Input / Output Signal	10bit HD Serial Digital Signal, SMPTE 292M, 1/4ch
Video Format	1080p 24/25/30
	1080i 50/60
	720p 24/25/30/50/60
Input Return Loss(BNC)	>-15 dB 270Mb-3Gb
Output Return Loss(BNC)	>-15 dB 270Mb-3Gb
Input Impedance(BNC)	75 Ohms+/-1%
Output Impedance(BNC)	75 Ohms+/-1%
Power Consumption	Free Voltage 12VDC, 1A
Dimension (W*H*D)	83.75mm x 31.75mm x 87.07mm / 3.35inch x 1.27 inch x 3.48 inch
HD-SDI Connector	BNC Female

13.5.4 Unpacking

- This equipment is an electronic appliance, so it should be handled with special care.

13.5.5 Service

- If there is any problem in the product, please contact a supplier or a distributor.

13.5.6 System Dimension Diagram

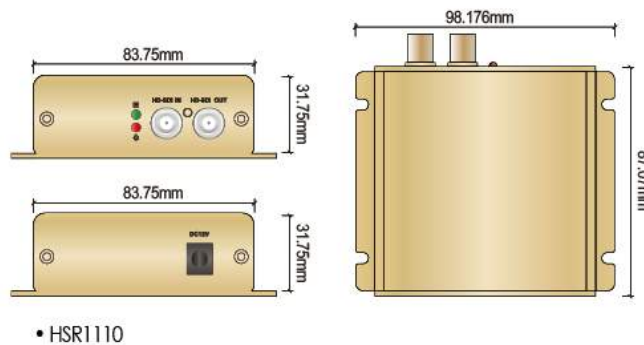

13.5.7 Connector Wiring



- 1 In / 1 Out HD-SDI Repeater (HSR1110)

13.5.7.1 1 In / 1 out HD-SDI Connections

- Connect an HD-SDI device (e.g. Camera) to '**HD-SDI IN**' of HD-SDI repeater.
- Connect an HD-SDI device (e.g. DVR) to '**HD-SDI OUT**' of HD-SDI repeater.

13.5.7.2 Power Supply Connections

- Plug the power supply adapter (**DC 12V, 3.33A**) which is included in this product to '**DC12V**' connector and plug another side to power source and Input voltage is a free volt (**100 VAC ~ 240 VAC**).

13.5.8 Cable



- 75 ohm coaxial cable

NOTE

The cable above is not included in the package.

13.5.9 Display

13.5.9.1 LEDs

KEYS		Operating mode
Power LED (Red)		<ul style="list-style-type: none"> • Light off: Repeater off • Light on: Repeater on
Connection LED (Green)		<ul style="list-style-type: none"> • Light off: Not connected • Light on: Connected

13.6 HSR1440

13.6.1 Introduction

- HSR 1440 is an HD-SDI repeater to extend the signal transmission distance between HD-SDI devices. The transmission distance is easily extended up to 150m and if it requires extending longer than 150m, it may connect another repeater to extend the signal transmission and it will be extended up to another 150m.

13.6.2 Features

- 4 In / 4 Out HD-SDI Repeater
- HD-SDI SMPTE 292M Support(1080p,1080i or 720p)
- Vertical Frequency Auto-Track(60,60/1.001)
- Low power Consumption: Free voltage 12VDC, 1A
- Compact Size & Light weight
- Input / Output return loss : >-15dB at 1.5GBPS
- Input / Output Impedance: 75Ohms+/-1%

13.6.3 Technical Specification

Model	HSR1440
Input / Output Signal	10bit HD Serial Digital Signal, SMPTE 292M, 1/4ch
Video Format	1080p 24/25/30
	1080i 50/60
	720p 24/25/30/50/60
Input Return Loss(BNC)	>-15 dB 270Mb-3Gb
Output Return Loss(BNC)	>-15 dB 270Mb-3Gb
Input Impedance(BNC)	75 Ohms+/-1%
Output Impedance(BNC)	75 Ohms+/-1%
Power Consumption	Free Voltage 12VDC, 1A
Dimension (W*H*D)	83.75mm x 31.75mm x 87.07mm / 3.35inch x 1.27 inch x 3.48 inch
HD-SDI Connector	BNC Female

13.6.4 Unpacking

- This equipment is an electronic appliance, so it should be handled with special care.

13.6.5 Service

- If there is any problem in the product, please contact a supplier or a distributor.

13.6.6 System Dimension Diagram

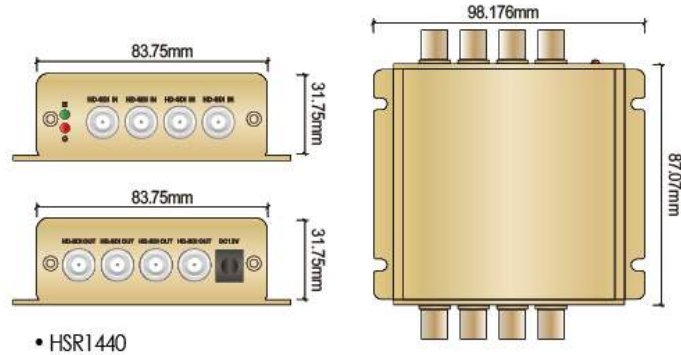

13.6.7 Connector Wiring

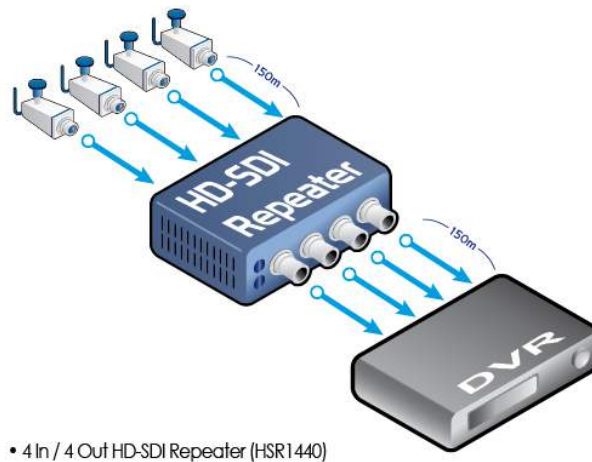

13.6.7.1 4 In/ 4 out HD-SDI Connections

- Connect 4 HD-SDI devices (e.g. Camera) to each of 4 '**HD-SDI IN**' of HD-SDI repeater.
- Connect 4 HD-SDI devices (e.g. DVR) to each of 4 '**HD-SDI OUT**' of HD-SDI repeater.

13.6.7.2 Power Supply Connections

- Plug the power supply adapter (**DC 12V, 3.33A**) which is included in this product to '**DC12V**' connector and plug another side to power source and Input voltage is a free volt (**100 VAC ~ 240 VAC**).

13.6.8 Cable



- 75 ohm coaxial cable

NOTE

The cable above is not included in the package.

13.6.9 Display

13.6.9.1 LEDs

KEYS	Operating mode
Power LED (Red) 	<ul style="list-style-type: none"> • Light off: Repeater off • Light on: Repeater on
Connection LED (Green) 	<ul style="list-style-type: none"> • Light off: Not connected • Light on: Connected

13.7 HQS1004

13.7.1 Introduction

- This device is an HD-SDI Video distribution amplifier which has 4 separately buffered HD-SDI outputs. This model is specially designed for 75 ohm HD Digital video distribution.

13.7.2 Features

- Compact HD-SDI Video Distribution Amplifier
- 1 HD-SDI Video Input(SMPTE 292M)
- 4 Separately Buffered HD-SDI Outputs(SMPTE 292M)
- Auto Equalization
- Auto Re-clock/ Bypass Any Rate from 10KBPS through 2.97GBPS
- Low Power Consumption: Free Voltage 12VDC, 1A
- Compact Size & Light Weight
- Input / Output Return Loss : >-15 dB

13.7.3 Technical Specification

Model	HQS 1004
Format	1080p, 1080i or 720p Manual Selection
Video Inputs	1 HD-SDI Input(SMPTE 292M)
Input Format	1080p 24/25/30
	1080i 50/60
	720p 24/25/30/50/60
Video Output	4 HD-SDI output (SMPTE 292M)
Output Format	1080p 24/25/30
	1080i 50/60
	720p 24/25/30/50/60
Input / Output Return Loss(BNC)	>-15dB, 270Mb-3Gb
Input / Output Impedance	75Ohms+/-1%
Power Consumption	Free Voltage 12VDC, 1A
Dimension (W*H*D)	83.75mm x 31.75mm x 87.07mm / 3.35inch x 1.27inch

13.7.4 Unpacking

- This equipment is an electronic appliance, so it should be handled with special care.

13.7.5 Service

- If there is any problem in the product, please contact the supplier or the distributor with qualified service personnel.

13.7.6 System Dimension Diagram

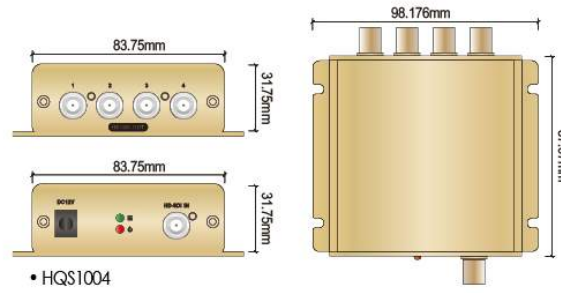

13.7.7 Connector Wiring

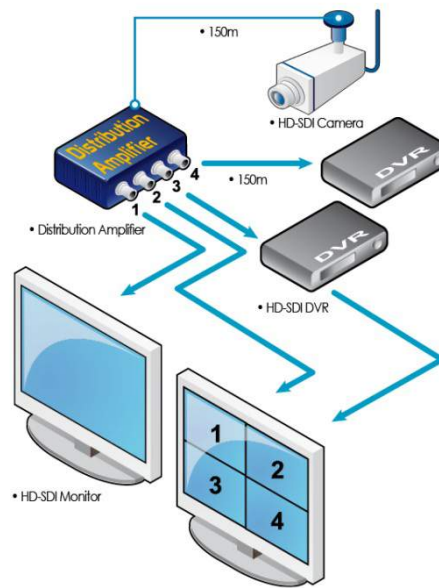

13.7.7.1 Distribution-In/Out Connections

- Connect an 'HD-SDI OUT' of HD-SDI device (e.g. Camera) to 'HD-SDI IN' of HQS 1004 using by 75 ohm coaxial cable
- Connect 4 'HD-SDI OUT' of HQS 1004 to each 'HD-SDI IN' of HD-SDI devices (e.g. DVR).

13.7.7.2 Power Supply Connections

- Plug the power supply adapter (**DC 12V, 3.33A**) which is included in this product to '**DC12V**' connector and plug another side to power source and Input voltage is a free volt (**100 VAC ~ 240 VAC**).

13.7.8 Cable





- 75 ohm coaxial cable

NOTE

The cable above is not included in the package.

13.7.9 Display

13.7.9.1 LEDs

KEYS		Operating mode
Power LED (Red)	 	<ul style="list-style-type: none"> • Light off: Repeater off • Light on: Repeater on
Connection LED (Green)	 	<ul style="list-style-type: none"> • Light off: Not connected • Light on: Connected

NOTE

Please note that this device has the same function as HD-SDI repeater that extends the signal transmission distance up to 150m.

13.8 HFO1100 & HFO1200

13.8.1 Introduction

- HFO 1100 Series are HD-SDI/Fiber optic converters which enable the transmission of HD-SDI signal up to 30km. These converters meet SMPTE 292M specification and are suitable for both indoor and outdoor use. HFO1200 receives the HD-SDI signal and send the signal out through fiber optic cable. HFO 1100 receives the signal from fiber optic cable and send it out through HD-SDI coaxial cable.

13.8.2 Features

- Transmission of HD-SDI over Single Mode Optical Fiber
- Auto-detection of Video Format
- HD-SDI Connector (SMPTE292M)
- LC Fiber Optic Connector
- Low Power Consumption: Free Voltage 12VDC, 1A
- Input / Output Return Loss : > -15dB at 1.5GBPS
- Input / Output Impedance : 75 Ohms +/- 1%
- All inputs, either SDI or Fiber, are equalized and re-clocked

13.8.3 Technical Specification

Model	HFO1100	HFO1200
Format	3 Gb, 1.5Gb, 270Mb Auto Detect	
Video Inputs	1 LC Fiber Optic Connector 1	HD-SDI Input(SMPTE 292M)
Input Format	1080p 24/25/30	
	1080i 50/60	
	720p 24/25/30/50/60	
Video Outputs	1HD-SDI Output(SMPTE 292M)	1 LC Fiber Optic Connector
Output Format	1080p 24/25/30	
	1080i 50/60	
	720p 24/25/30/50/60	
Cable Equalization (BNC Inputs, 1694 Coax)	270mb, 460m	
	1.5Gb, 230m	
	3Gb, 150m	
Input Return Loss(BNC)	>-15dB, 270Mb-3Gb	
Output Return Loss(BNC)	>-15dB,270Mb-3Gb	
Input Impedance	75Ohms+/-1%	
Output Impedance(BNC)	75Ohms+/-1%	
Optical Outputs	Wavelength:13 10nm	
	Output Power:-2dBm Typical	
Power Consumption	Free Voltage 12VDC, 1A	
Dimension (W*H*D)	83.75mm x 31.75mm x 87.07mm / 3.35inch x 1.27inch	

13.8.4 Unpacking

- This equipment is an electronic appliance, so it should be handled with special care.

13.8.5 Service

- If there is any problem in the product, please contact the supplier or the distributor.

13.8.6 System Dimension Diagram

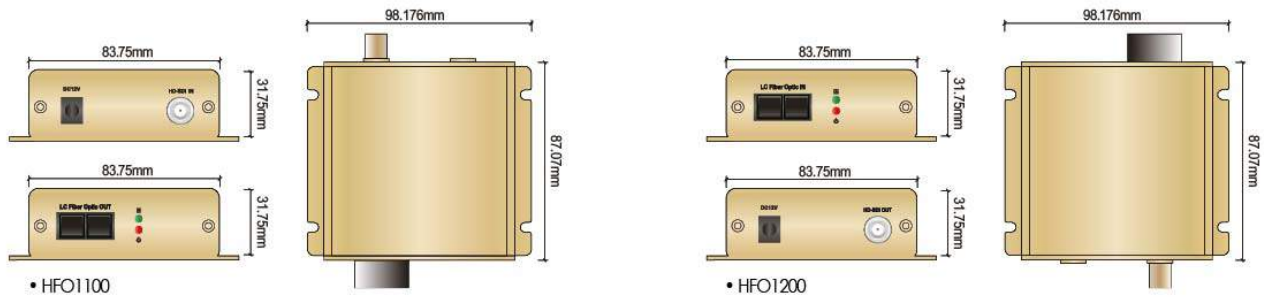

13.8.7 Connector Wiring

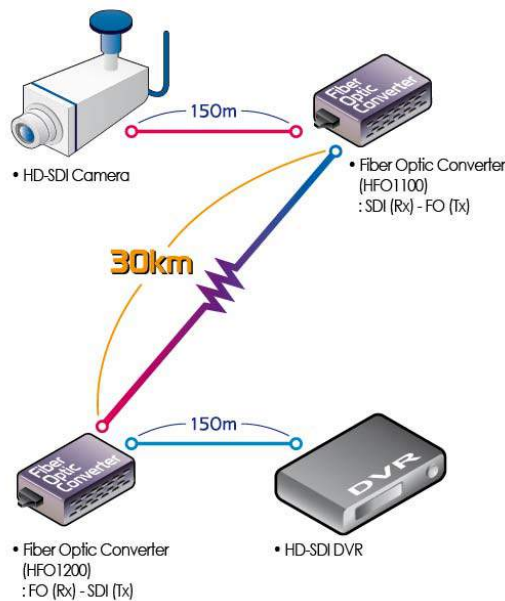

13.8.7.1 HD-SDI in Connections

- Connect HD-SDI Camera to ‘**HD-SDI IN**’ of HFO1200 using 75 ohm coaxial cable

13.8.7.2 Fiber Optic Out Connections

- Connect the “**LC Fiber Optic out**” of HFO1200 which can be connected to opposite site of Fiber optic converter (HFO 1100) by using the fiber optic cable.

13.8.7.3 Fiber Optic in Connections

- Connect the fiber optic cable which is coming from the opposite site of HFO1200 to “**LC Fiber Optic In**” of HFO 1100.

13.8.7.4 HD-SDI out connections

- Connect the ‘**HD-SDI OUT**’ of HFO 1200 to ‘**HD-SDI IN**’ of HD-SDI device by using 75ohm coaxial cable.

13.8.7.5 Power Supply Connections

- Plug the power supply adapter (**DC 12V, 3.33A**) which is included in this product to ‘**DC12V**’ connector and plug another side to power source and Input voltage is a free volt (**100 VAC ~ 240 VAC**).

13.8.8 Cable



- 75 ohm coaxial cable is needed
- Fiber Optic Cable

NOTE

The cables above are not included in the package.

13.8.9 Display

13.8.9.1 LEDs

KEYS	Operating mode
Power LED (Red) 	<ul style="list-style-type: none">• Light off: Converter off• Light on: Converter on
Connection LED (Green) 	<ul style="list-style-type: none">• Light off: Not connected• Light on: Connected