

Standalone Digital Video Recorder

Premium DVR 4, 8, 16 Channel Models

User`s Manual



MADE IN KOREA

FCC Compliance Statement

Notice to Users: This equipment has been tested and found to comply with the limits for a Class A digital device. Pursuant to Part 15 of the FCC Rules, these limits are designed to provide reasonable protection against harmful interference when the equipment is operated in a commercial environment. This equipment generates uses and can radiate radio frequency energy and, if not installed and used in accordance with the instruction manual, may cause harmful interference to radio communications. Operation of this equipment in a residential area is likely to cause harmful interference in which case the user will be required to correct the interference at own expense.

CAUTION

CHANGES OR MODIFICATIONS NOT EXPRESSLY APPROVED BY THE PARTY RESPONSIBLE FOR COMPLIANCE COULD VOID THE USER'S AUTHORITY TO OPERATE THE EQUIPMENT.

ATTENTION

DES CHANGEMENTS OU DES MODIFICATIONS NON EXPRESSEMENT APPROUVEES PAR LE RESPONSABLE DE LA CONFORMITE POURRAIENT ANNULER L'AUTORISATION DE L'UTILISATEUR A EXPLOITER L'EQUIPEMENT.

The equipment complies with the requirement of FCC CFR 47 PART 15 SUBPART B, Class A.

Explanation of Graphical Symbols



This symbol indicates the presence of important operating and maintenance (servicing) instruction in the literature accompanying the product.

Ce symbole indique la présence d'instructions importantes et de maintenances dans le manuel accompagnant le produit



This symbol indicates the presence of non-insulated "dangerous voltage" within the product's enclosure that may be of sufficient magnitude to constitute a risk of electric shock to persons.

Ce symbole indique la présence de « haute tension » non-isolé dans le produit qui peut avoir pour conséquence un risque de la décharge électrique aux personnes.

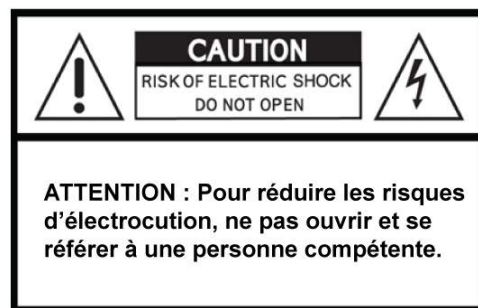
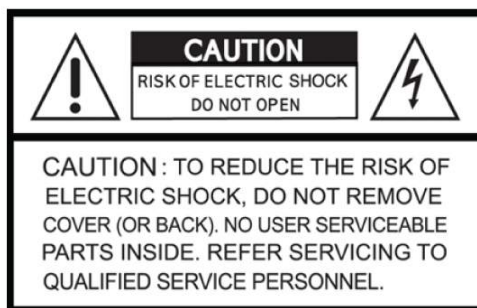

Warnings

- Installation and servicing should be performed only by qualified and experienced personnel.
- Power off the DVR when connecting cameras, audio, or sensor cables.
- The manufacturer is not responsible for any damage caused by improper use of the product or failure to follow instructions for the product.
- The manufacturer is not responsible for any problems caused by or resulting from the user physically opening the DVR for examination or attempting to fix the unit.
- The manufacturer may not be held liable for any issues with the unit if any labels are removed in the product.

Cautions

- This product has free voltages (100V ~ 240V). See installation instructions before connecting to the power supply.
- This product uses a Lithium battery.
- To avoid any risk of explosion, do not replace the battery on the main board by anything other than a Lithium battery.
- Dispose of used batteries according to the manufacturer's instructions.
- This equipment and all communication wirings are intended for indoor use only.
- To reduce the risk of fire or electric shock, do not expose the unit to rain or moisture.

WEEE(Waste Electrical and Electronic Equipment)

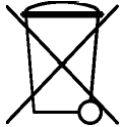

Customers in European Union countries are advised to dispose this product, at the end of its useful life, as per applicable local laws, regulations and procedures.

Important Safeguards

1. Read Instructions

- To reduce the risk of fire or electric shock, do not expose the unit to rain or moisture.

2. Retain Instructions

- The safety and operating instructions should be retained for future reference.

3. Cleaning

- Unplug this equipment from the wall outlet before cleaning it. Do not use liquid aerosol cleaners. Use a damp soft cloth for cleaning.

4. Attachments

- Never add any attachments and/or equipment without manufacturer approval as such additions may result in the risk of fire, electric shock, or other personal injury.

5. Water and/or Moisture

- Do not use this equipment near water or in contact with water.

6. Accessories

- Do not place this equipment on an unstable cart, stand or table. The equipment may fall, causing serious injury to a child or adult and serious damage to the equipment.
- Wall or shelf mounting should follow the manufacturer's instructions and should use a mounting kit approved by the manufacturer.



- Move this equipment and cart combination with care. Quick stops, excessive force and uneven surfaces may cause the equipment and cart combination to overturn.

7. Power Sources

- This equipment should be operated only from the type of power source indicated on the marking label. If not sure the type of power, please consult to distributor or local power company.
- UPS (Uninterruptible Power Supply) is highly recommended when the power input is not stable to protect DVR and HDD(s).

8. Power Cords

- Operator or installer must remove power, BNC, alarm and other connections before moving the equipment.

9. Lightning

- For added protection for this equipment during a lightning storm, or when it is left unattended and unused for long periods of time, unplug it from the wall outlet and disconnect the antenna or cable system. This will prevent damage to the equipment due to lightning and power-line surges.

10. Overloading

- Do not overload wall outlets and extension cords to avoid the risk of fire or electric shock.

11. Objects and Liquids

- Never push objects of any kind through openings of this equipment as they may touch dangerous voltage points or short out parts that could result in a fire or electric shock.
- Never spill liquid of any kind on the equipment.

12. Servicing

- Do not attempt to service this equipment yourself. Refer all servicing to qualified service personnel.

13. Damage Requiring Service

- Unplug this equipment from the wall outlet and refer servicing to qualified service personnel under the following conditions:
 - ① When the power-supply cord or the plug has been damaged.
 - ② If liquid is spilled or objects have fallen into the equipment.
 - ③ If the equipment has been exposed to rain or water.
 - ④ If the equipment does not operate normally by following the operating instructions, adjust only those controls that are covered by the operating instructions as an improper adjustment of other controls may result in damage and will often require extensive work by a qualified technician to restore the equipment to its normal operation.
 - ⑤ If the equipment has been dropped or damaged the cabinet.
 - ⑥ When the equipment exhibits a distinct change in performance—this indicates a need for service.

14. Replacement Parts

- When replacement parts are required, ensure the service technician uses replacement parts specified by the manufacturer or that have the same characteristics as the original part. Unauthorized substitutions may result in fire, electric shock, or other hazards.

15. Safety Check

- Upon completion of any service or repairs to this equipment, ask the service technician to perform safety checks to determine that the equipment is in proper operating condition.

16. Field Installation

- This installation should be made by a qualified service person and should conform to all local codes.

17. Correct Batteries

CAUTION

RISK OF EXPLOSION IF BATTERY IS REPLACED BY AN INCORRECT TYPE.
DISPOSE OF USED BATTERIES ACCORDING TO THE INSTRUCTIONS

ATTENTION

RISQUE D'EXPLOSION SI LA BATTERIE EST REMPLACÉE PAR UN TYPE INCORRECT
DISPOSEZ DE BATTERIES EN ACCORS AVEC LES INSTRUCTIONS

18. Operating Temperature

- An operating temperature range is specified so that the customer and installer may determine a suitable operating environment for the equipment.

19. Elevated Operating Ambient Temperature

- If installed in a closed or multi-unit rack assembly, the operating ambient temperature of the rack environment may be greater than room ambient. Therefore, consideration should be given to installing the equipment in an environment compatible with the specified operating temperature range.

20. Reduced Air Flow

- Installation of the equipment in the rack should be such that the amount of airflow required for safe operation of the equipment is not compromised.

21. Mechanical Loading

- Mounting of the equipment in the rack should be such that a hazardous condition is not caused by uneven mechanical loading.

22. Circuit Overloading

- Consideration should be given to connection of the equipment to supply circuit and the effect that overloading of circuits might have on over-current protection and supply wiring. Appropriate consideration of equipment nameplate ratings should be used when addressing this concern.





23. Grounding (Earthing)

- Connection of ground wire is highly recommended to protect the DVR from external electric shock, such as lightning, electrical surge.

WARNING

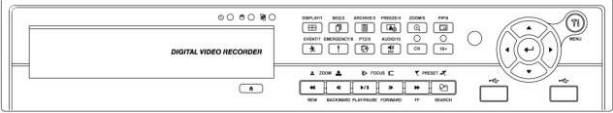
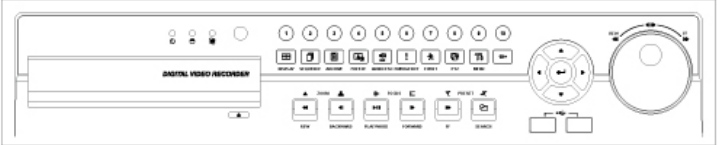
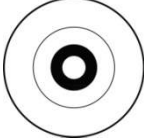
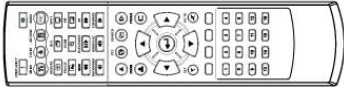
WARRANTY IS VOID IF SEAL OR LABEL IS REMOVED OR DAMAGED.

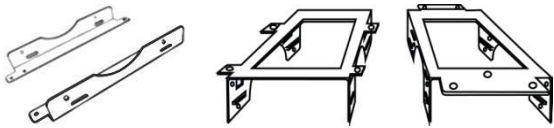
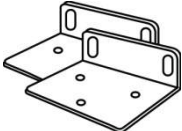
The List of Configuration

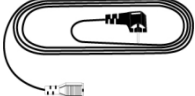
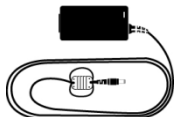
<p>DVR Set</p>	<p>S (4, 8 CH), A and E (4CH) Type : 4 / 8 / 16CH</p>  <p>B and E (8, 16CH) Type : 4 / 8 / 16CH</p>  <p>C, D, F, G, H, I and J (8, 16CH) Type : 4 / 8 / 16CH</p> 
<p>Manual / CMS CD</p>	
<p>Remote Controller</p>	
<p>Quick Guide</p>	
<p>Screws</p>	
<p>HDD Brackets</p>	
<p>Rack Bracket (Except S, A, B and E Type)</p>	
<p>Data Cable</p>	
<p>Power Cable</p>	
<p>Adapter (Except G 8/16CH Type)</p>	

Mandatory Setup & Operation Precautions

● STEP 1. Date / Time Configuration ('before' HDD(s) installation)

- Plug a network cable, if any.
- Turn on the DVR and press 'OK' on no HDD(s) detection message.
- Go to **SETUP>SYSTEM>General>Setup**.
- Check on 'NTP Setup' box, and then select your 'Time Zone'.
- Select DST (Daylight Saving Time) 'On' or 'Off' accordingly.
- When the DVR has no internet connection, adjust Date/Time manually. Otherwise the DVR will adjust the correct time every hour automatically.
- Click/Select 'EXIT' on your right and top corner.
- Turn off the DVR for Step 2 (HDD(s) installation).

● STEP 2. HDD(s) Installation / Addition / Moving / Replacement / Removal

- **HDD(s) Installation/Addition:** Make sure the DVR is turned off. Connect a power cable and a SATA cable from DVR's main board to HDD(s). Use SATA port #1 (written on the board) for the first HDD and in order. Power the DVR on and follow the screen. DVR starts recording. No rebooting required.
- **HDD(s) Removal:** Make sure the DVR is turned off. Disconnect a power and a SATA cable from DVR's main board to HDD(s). Power the DVR on and follow the screen. (You may leave SATA port #1 unused when you removed the attached #1 HDD.)
- **HDD(s) Selection:** Even most of HDDs are compatible with DVRs; suggested HDD list is available by request.

● Power Off

- Do not turn DVR off, or plug off the power adapter while DVR is in operations (record/playback). It may cause permanent damage to the equipment. Please Click (←) **Shutdown** on System Menu Bar and then **UNPLUG** the power cable after DVR is shut down completely. It is safe to wait for 5 seconds before turning the power on again. ('Shut Down' by DVR's menu selection does NOT physically power off the machine. Please physically unplug the power cable from the DVR to completely turn off.)
- Do not turn off External storage device (e.g., USB memory stick (powered), removable external hard disk, and similar) while the DVR is on. It may cause permanent damage to the equipment. When you have to turn off external storage device, make sure the DVR is turned off. When you turn those on, turn on external storage first and then DVR. (you may unplug simple USB thumb drive freely unless it is in archiving process)
- Do not turn DVR off, or plug off the power adapter when the DVR is formatting an HDD(s). It may cause permanent damage to the equipment. Make sure the power is "ON" until the formatting of an HDD is completed. (note, a DVR formats HDD(s) in seconds)

● Monitor resolution

- For the best picture display, a DVR's local monitor output has a default resolution of 1920x1080 pixels. If your attached monitor does not support 1080p resolution, and you cannot see any picture, please change the DVR's resolution to the lowest as following.
- The lowest resolution (1024x768) Hot Keys: Use your 'Remote Controller' (It comes with a DVR)
- Press followings in order one by one. **REW>FF>BACKWARD>FORWARD**
- The resolution should be changed to 1024x768.

● Default Password

- For all (DVRs and Software) default password is 1111 (four 1(one)s).
- For your protection, it is strongly recommended to change. Computer-like passwords are supported.

● Upgrade

- You may upgrade a DVR when the HDDs are added properly.
- Contact your dealer/technical support when you need a help on updating.

Table of Contents

1. PRODUCT FEATURES	11	4.3.5 Camera.....	53
1.1 Unpacking.....	11	4.3.6 Audio.....	54
1.2 Service.....	11	4.3.7 Text-In.....	54
1.3 System Connection Diagram.....	11	4.4 RECORD	54
2. INSTALLATION	24	4.4.1 Record.....	54
2.1 Hard disk and DVD-RW Installation.....	24	4.4.2 Schedule.....	59
2.1.1 SATA Port.....	24	4.4.3 Motion.....	60
2.1.2 Internal SATA Storage.....	25	4.5 RELAY	60
2.1.3 e-SATA External Storage.....	25	4.5.1 ALARM IN.....	61
2.1.4 HDD Installation.....	25	4.5.2 MOTION.....	61
2.1.5 HDD Capacity.....	25	4.5.3 EMERGENCY.....	62
2.1.6 DVD-RW Installation.....	25	4.5.4 TEXT-IN.....	63
2.2 Connector Wiring.....	26	4.5.5 VIDEO LOSS.....	63
2.2.1 Video-In/Loop Out Connections.....	26	5. OPERATION INSTRUCTION	65
2.2.2 HD-SDI Input Signal detection.....	26	5.1 Viewing.....	65
2.2.3 Monitor Connections.....	26	5.1.1 First Image.....	65
2.2.4 HDMI connections.....	27	5.1.2 View Format.....	66
2.2.5 Audio Connections.....	27	5.1.3 Digital Zoom.....	66
2.2.6 TCP/IP (Ethernet) Connections.....	27	5.1.4 Freeze Live Image.....	66
2.2.7 Alarm Connections (TTL).....	27	5.1.5 Pan / Tilt / Zoom Control.....	67
2.2.8 Master Alarm.....	28	5.1.6 System Log.....	68
2.2.9 Alarm Connections (Relay).....	28	5.1.7 Key Lock.....	68
2.2.10RS-485/422 Connections.....	28	5.1.8 Emergency Recording.....	68
2.2.11RS-485 Over Coax Connection.....	28	5.1.9 Alarm Out Control and Acknowledge.....	68
2.2.12USB Connections.....	28	5.2 Playback.....	69
2.2.13Grounding (Earthing).....	28	5.2.1 Search.....	70
2.2.14Factory Reset Switch.....	28	5.2.2 Digital Zoom in Playback.....	72
2.2.15Power Supply connections.....	28	5.2.3 One-touch Playback.....	72
2.2.16Connections Guideline.....	29	5.3 Menu Bar.....	72
3. INPUT DEVICE AND SCREEN ICONS	30	5.4 Bookmark.....	73
3.1 Key and LEDs.....	30	5.5 Archive.....	73
3.2 Camera Select Keys for 16 Channel DVR....	32	6. CMS PRO	76
3.3 Front Panel.....	33	6.1 CMS Pro Features.....	76
3.4 Using a Remote Controller.....	33	6.1.1 Introduction.....	76
3.5 Using a Mouse.....	34	6.1.2 Features.....	76
3.6 Screen Icon.....	35	6.1.3 System Requirements.....	76
4. SETUP	36	6.2 Installation.....	77
4.1 Login.....	36	6.2.1 Software Installation.....	77
4.2 SYSTEM.....	37	6.2.2 Login.....	78
4.2.1 Status.....	37	6.3 Menu.....	79
4.2.2 General.....	37	6.4 Setup.....	80
4.2.3 Event.....	42	6.4.1 Local Setup - Device.....	80
4.3 DEVICE.....	44	6.4.2 Device Group Setup.....	82
4.3.1 Display.....	44	6.4.3 Local Setup - Environment.....	83
4.3.2 Network.....	47	6.4.4 Local Setup - Account.....	86
4.3.3 Alarm.....	49	6.4.5 Local Setup - E-map.....	87
4.3.4 Storage.....	50	6.4.6 Remote Device Setup.....	90
		6.4.7 Change Password.....	91
		6.4.8 Help.....	91

6.5 View	91	8.1 Program Installation	123
6.5.1 Server List.....	92	8.1.1 System Recommendations	123
6.5.2 Remote Device System Log	92	8.1.2 Program Installation Method	123
6.5.3 Remote Device Event Log	92	8.2 Login	124
6.5.4 CMS System Log.....	93	8.3 Watch Mode.....	124
6.5.5 Health Check.....	93	8.3.1 Login Screen	124
6.5.6 Show All Windows	95	8.3.2 Local Setting.....	125
6.6 Application.....	95	8.3.3 Live	127
6.6.1 Search	95	8.4 Search Mode	130
6.6.2 Exit.....	95	8.4.1 Date/Time Search.....	130
6.7 Live (Live Video Monitoring System).....	96	8.4.2 Event Search	131
6.7.1 Overview	96	8.4.3 POS/ATM.....	132
6.7.2 Live Monitor Menu.....	96	8.5 Disconnection	133
6.7.3 Screen Layout Control.....	102	8.6 Uninstall.....	134
6.7.4 Change Division Display	102	9. CMS WEB CLIENT PRO	136
6.7.5 Sequencing	102	9.1 System Requirements.....	136
6.7.6 Audio Volume Control	103	9.2 Setup and Login.....	136
6.8 Search	103	9.3 Live Display	137
6.8.1 Overview	103	9.4 Search Screen.....	138
6.8.2 Time Bar Search.....	103	9.5 PTZ Control	139
6.8.3 Event Search.....	105	9.6 Capture	140
6.8.4 POS/ATM Search	105	10. CMS MOBILE VIEWER	142
6.8.5 Thumbnail Search	106	10.1 iPhone / iPad (mViewer Pro)	142
6.8.6 Smart Search	106	10.1.1 System Requirements	142
6.9 E-Map	107	10.1.2 Installation	142
6.9.1 Overview	107	10.1.3 Site Registration	143
6.9.2 Controls.....	107	10.1.4 Connection	144
6.9.3 E-map Camera – Instant Playback...	107	10.1.5 Live View (Portrait View)	145
6.9.4 Alarm In/Out Control	108	10.1.6 Live View (Landscape View)	146
6.9.5 Audio	108	10.1.7 PTZ Control.....	146
6.10 Uninstalling CMS Pro	108	10.1.8 Search	147
7. ICMS VIEWER.....	110	10.1.9 Snapshot gallery	148
7.1 System Recommendations	110	10.1.10 Setting	149
7.2 Program Installation	110	10.1.11 Uninstallation	149
7.3 Login	111	10.2 Android Phone (mViewer Pro)	150
7.4 Watch Mode	111	10.2.1 System Requirements	150
7.4.1 Log-in Screen	111	10.2.2 Installation	150
7.4.2 Local Setting.....	112	10.2.3 Site Registration	151
7.5 Live View	115	10.2.4 Connection	152
7.5.1 Connection.....	115	10.2.5 Live View (Portrait View)	152
7.5.2 Display Mode	115	10.2.6 Live view (Landscape View).....	153
7.5.3 Health Check.....	116	10.2.7 PTZ control	154
7.5.4 PTZ Control.....	116	10.2.8 Alarm Out Control.....	154
7.5.5 System Log	117	10.2.9 Search	155
7.6 Search Mode.....	117	10.2.10 Snapshot Gallery.....	156
7.6.1 Date/Time Search	117	10.2.11 Setting	156
7.6.2 Event Search.....	118	10.2.12 Uninstallation	157
7.6.3 POS/ATM	119	11. KEYBOARD CONTROLLER (AVK-P2500)	159
7.7 Disconnection	120	11.1 Connection.....	159
7.8 Uninstall	121	11.1.1 Configuration Diagram	159
8. XCMS VIEWER	123		

11.1.2 USB Connection	159	13.3.1 Introduction	180
11.2 Keyboard Setup in DVR	159	13.3.2 Features	180
11.3 Keyboard Configuration	160	13.3.3 Technical Specification	181
11.4 Setup	162	13.3.4 Unpacking	181
11.4.1 DVR Control Mode	162	13.3.5 Service	181
11.4.2 Speed Dome Setup	162	13.3.6 System Dimension Diagram	181
11.4.3 Joystick Calibration	162	13.3.7 Connector Wiring	181
11.5 Operation	163	13.3.7.2 RS-485 Connection	182
11.5.1 DVR/SPD Mode Conversion	163	13.3.7.3 Power Supply Connection	182
11.5.2 DVR Control Mode	163	13.3.8 PTZ Control	182
11.5.2.1 Connection	163	13.3.9 Cable	182
11.5.2.2 Buttons	163	13.3.10 Display	182
11.5.2.3 PTZ Mode	164	13.4 HSC2410	183
11.5.3 SPD Control Mode (Speed Dome) ...	164	13.4.1 Introduction	183
11.5.3.1 Connection	164	13.4.2 Features	183
12. TEXT-IN (POS)	167	13.4.3 Technical Specification	183
12.1 Usage of Serial-In Function	167	13.4.4 Unpacking	183
12.2 Connection Method	167	13.4.5 Service	183
12.3 Connection Diagram	167	13.4.6 System Dimension Diagram	183
12.4 Relay	169	13.4.7 Connector Wiring	184
12.4.1 Relay Setup (Optional)	169	13.4.8 Cable	184
12.4.2 Schedule Setup (Mandatory)	170	13.4.9 Display	184
12.5 Setup (Mandatory)	170	13.5 HSR1110	184
12.5.1 Text Overlay	170	13.5.1 Introduction	184
12.5.2 Link Cam	171	13.5.2 Features	184
12.5.3 Device Setting	171	13.5.3 Technical Specification	185
12.5.4 Example	172	13.5.4 Unpacking	185
12.6 Search	173	13.5.5 Service	185
13. HD-SDI VIDEO SIGNAL ACCESSORIES. 177		13.5.6 System Dimension Diagram	185
13.1 HSC1100	177	13.5.7 Connector Wiring	185
13.1.1 Introduction	177	13.5.8 Cable	186
13.1.2 Features	177	13.5.9 Display	186
13.1.3 Technical Specification	177	13.6 HSR1440	186
13.1.4 Unpacking	177	13.6.1 Introduction	186
13.1.5 Service	177	13.6.2 Features	186
13.1.6 System Dimension Diagram	177	13.6.3 Technical Specification	186
13.1.7 System Connection Diagram	178	13.6.4 Unpacking	187
13.1.8 Cable	178	13.6.5 Service	187
13.1.9 Display	178	13.6.6 System Dimension Diagram	187
13.2 HSC1200	178	13.6.7 Connector Wiring	187
13.2.1 Introduction	178	13.6.8 Cable	187
13.2.2 Features	179	13.6.9 Display	188
13.2.3 Technical Specification	179	13.7 HQS1004	188
13.2.4 Unpacking	179	13.7.1 Introduction	188
13.2.5 Service	179	13.7.2 Features	188
13.2.6 System Dimension Diagram	179	13.7.3 Technical Specification	188
13.2.7 Connector Wiring	179	13.7.4 Unpacking	188
13.2.8 Cable	180	13.7.5 Service	188
13.2.9 Operation Key and Screen Display		13.7.6 System Dimension Diagram	189
Information	180	13.7.7 Connector Wiring	189
13.3 HSC2110	180	13.7.8 Cable	189
		13.7.9 Display	189
		13.8 HFO1100 & HFO1200	190
		13.8.1 Introduction	190

13.8.2Features 190
13.8.3Technical Specification 190
13.8.4Unpacking 190
13.8.5Service..... 190
13.8.6System Dimension Diagram..... 191

13.8.7Connector Wiring191
13.8.8Cable191
13.8.9Display192

1. Product Features

1.1 Unpacking

- This equipment is an electronic appliance, so it should be handled with special care.
- After unpacking, please check if all the following items are included.
 - DVR Main body
 - **S Type**: Power Supply Adapter (DC 12V, 3A) and Power Supply Cable
 - **A, B and E (4CH) Type**: Power Supply Adapter (DC 12V, 5A) and Power Supply Cable
 - **C, D, E (8, 16CH), F, G (4CH), H, I and J Type**: Power Supply Adapter (DC 12V, 6.67A) and Power Supply Cable
 - **G (8, 16CH) Type**: Power Supply Cable
 - Remote Control With 2 AAA batteries
 - Installation CD (CMS Pro Software & User's Manual)
 - Quick Guide

1.2 Service

- If there is any problem in the product, please refer servicing to a supplier or a distributor with qualified service personnel.

WARNING
WARRANTY IS VOID IF SEAL OR LABEL IS REMOVED OR DAMAGED.

1.3 System Connection Diagram

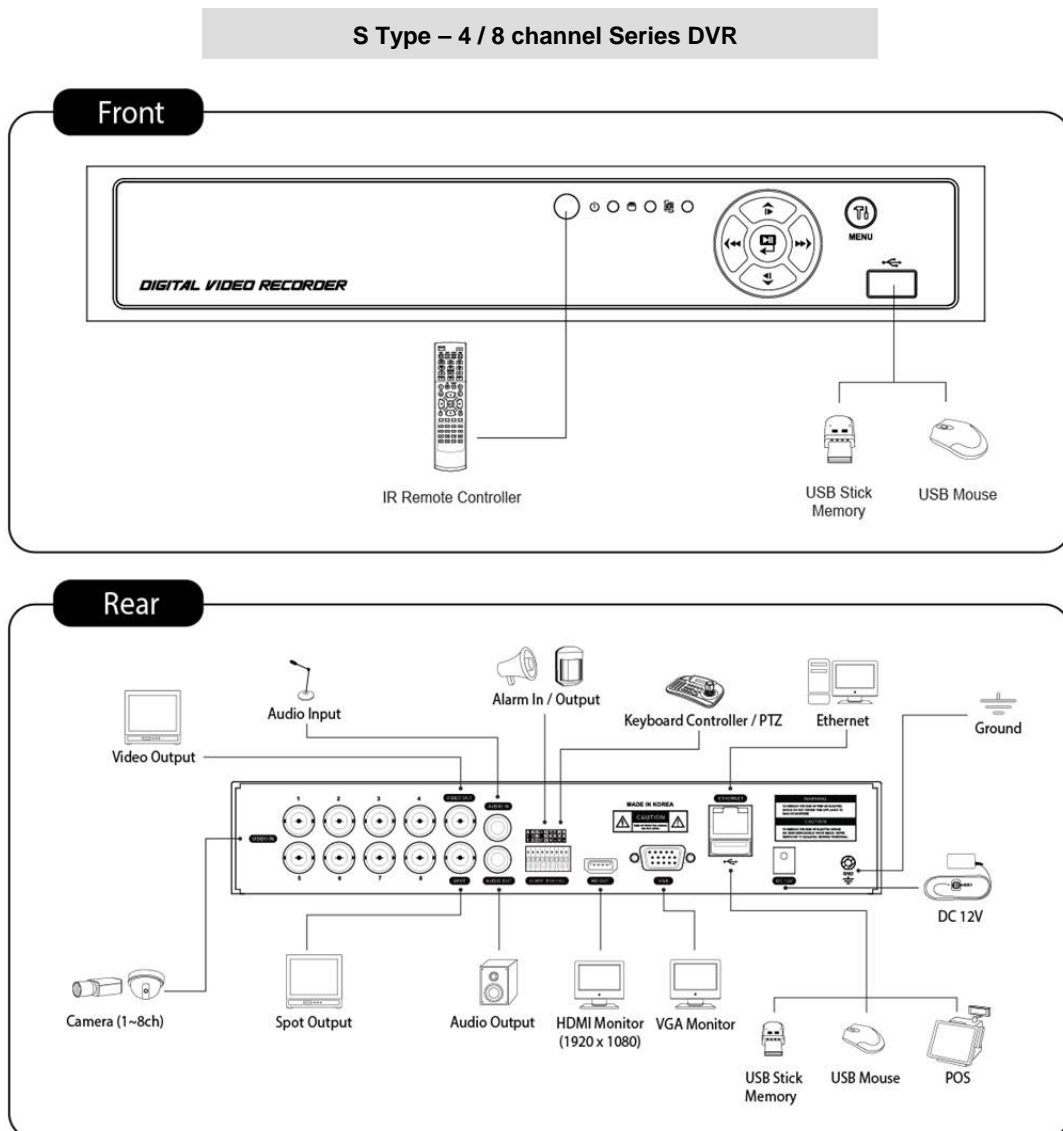

A Type – 4 / 8 / 16 channel Series DVR

Front

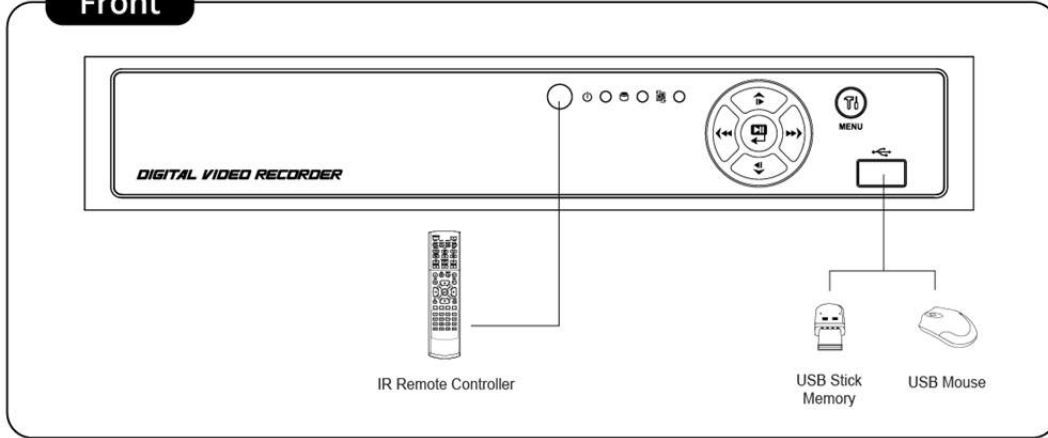

Rear

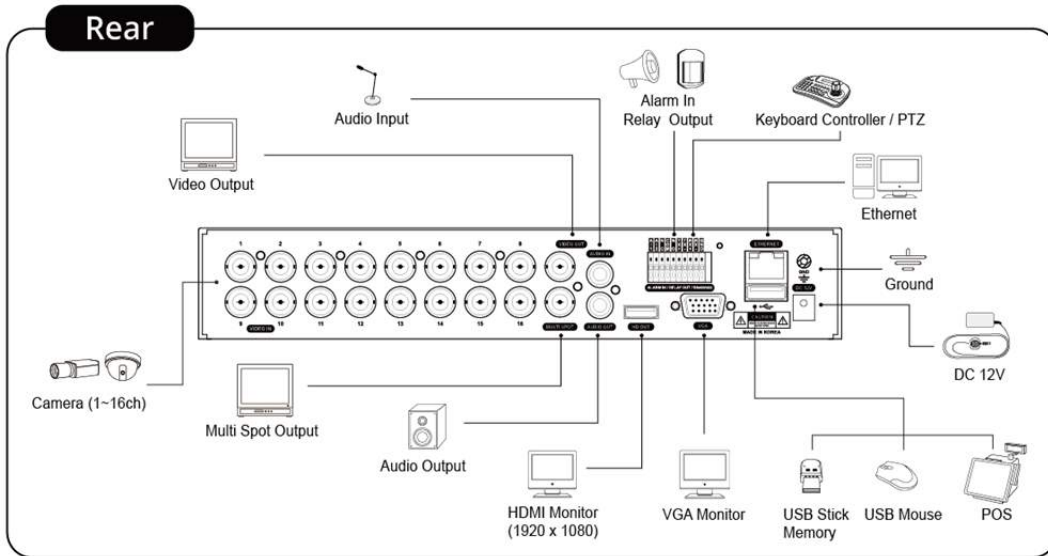

B Type – 4 / 8 / 16 channel Series DVR

Front

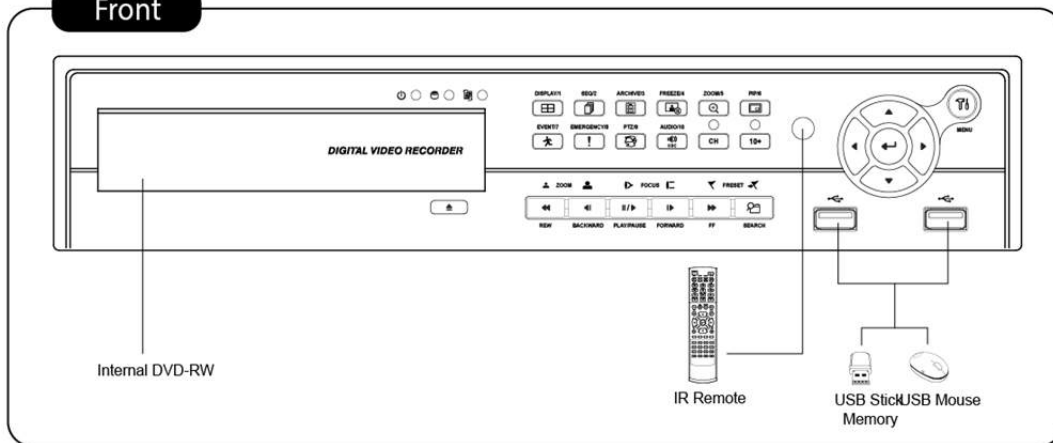

Internal DVD-RW

IR Remote

USB Stick
USB Mouse
Memory

Rear

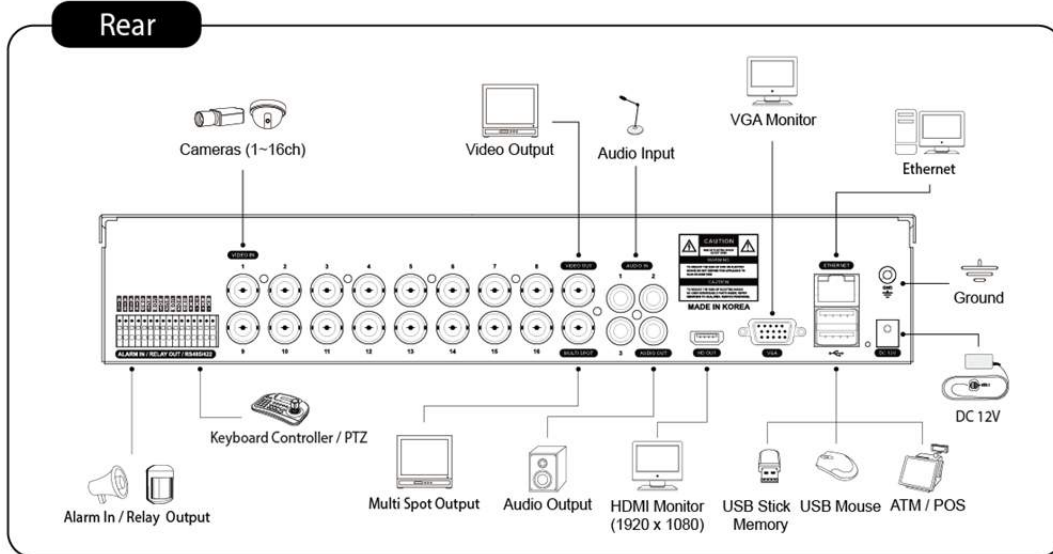

Alarm In / Relay Output

Keyboard Controller / PTZ

Multi Spot Output

Audio Output

HDMI Monitor (1920 x 1080)

USB Stick

USB Mouse

ATM / POS Memory

C Type – 4 / 8 / 16 channel Series DVR

Front

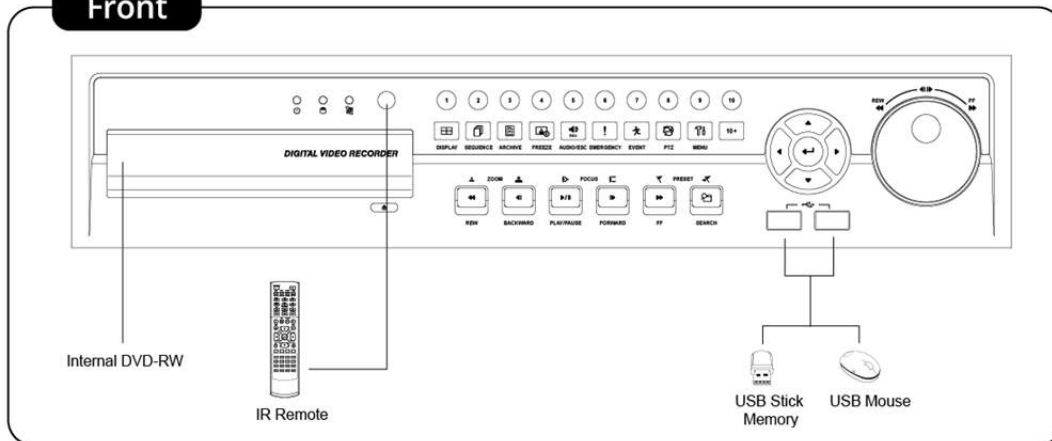

Rear

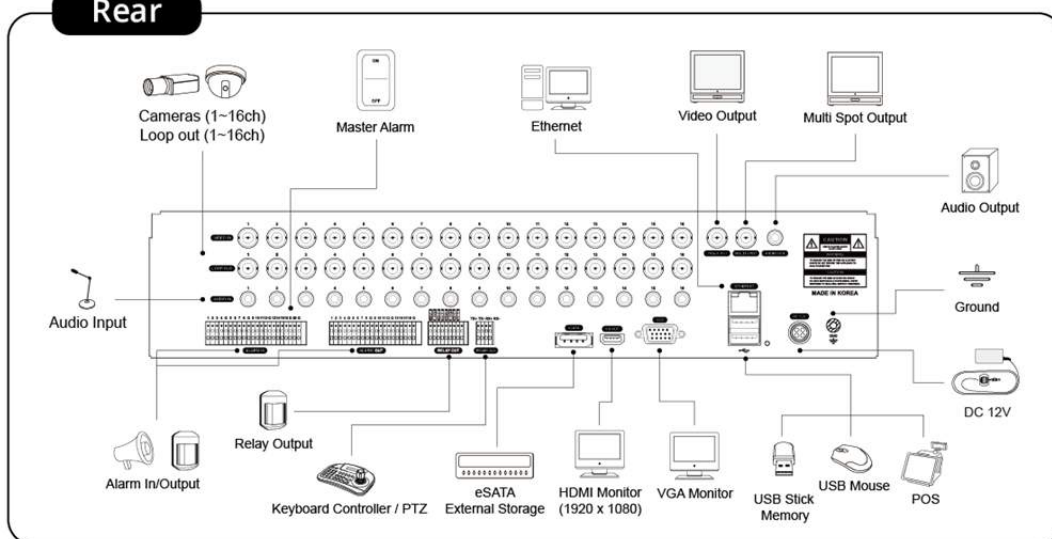

D Type – 4 / 8 / 16 channel Series DVR

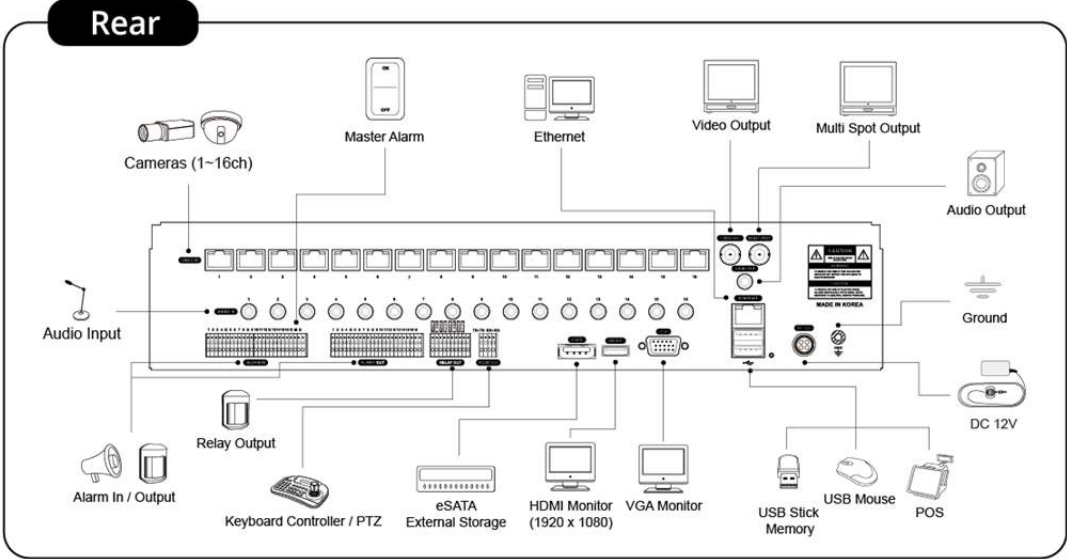
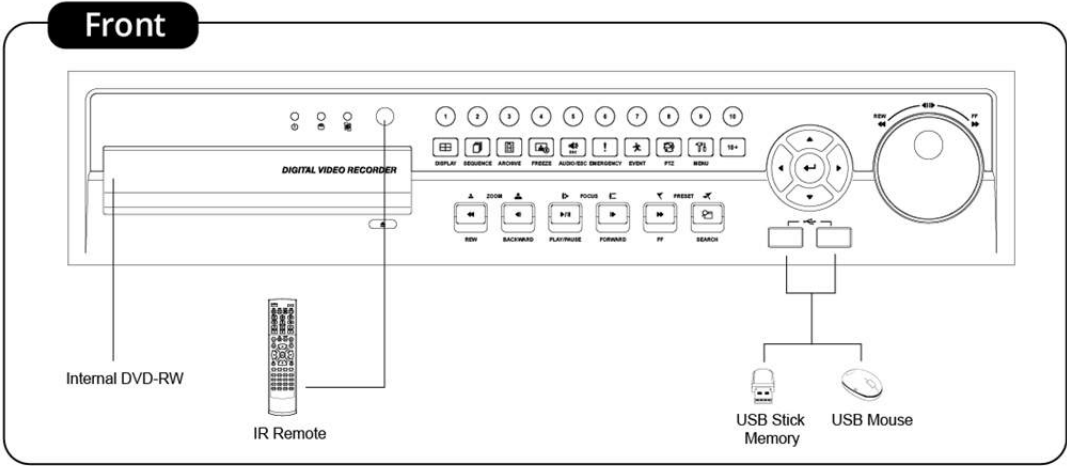

E Type – 4 channel Series HD-SDI DVR

Front

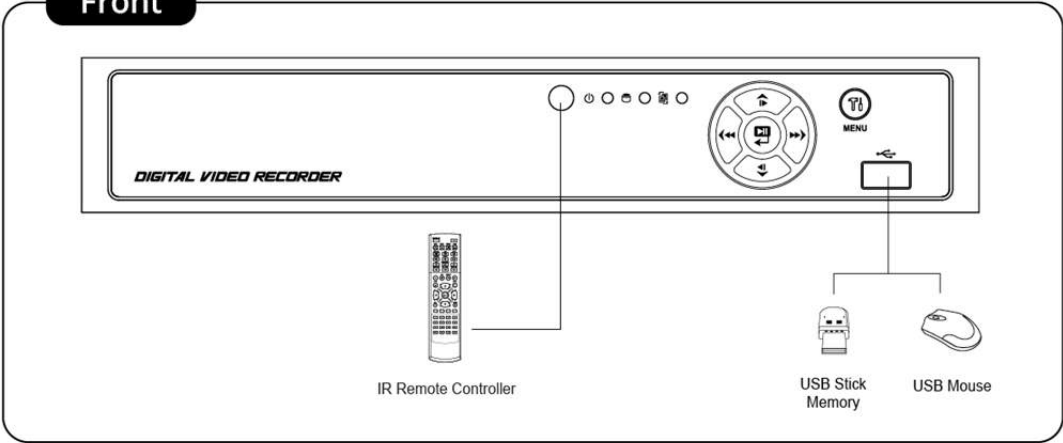

Rear

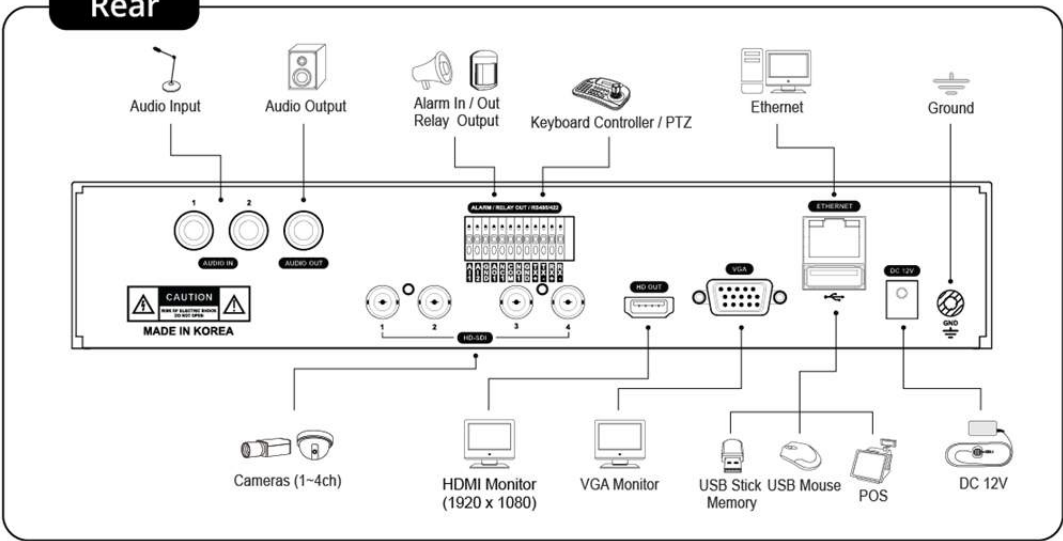

E Type – 8 / 16 channel Series HD-SDI DVR

Front

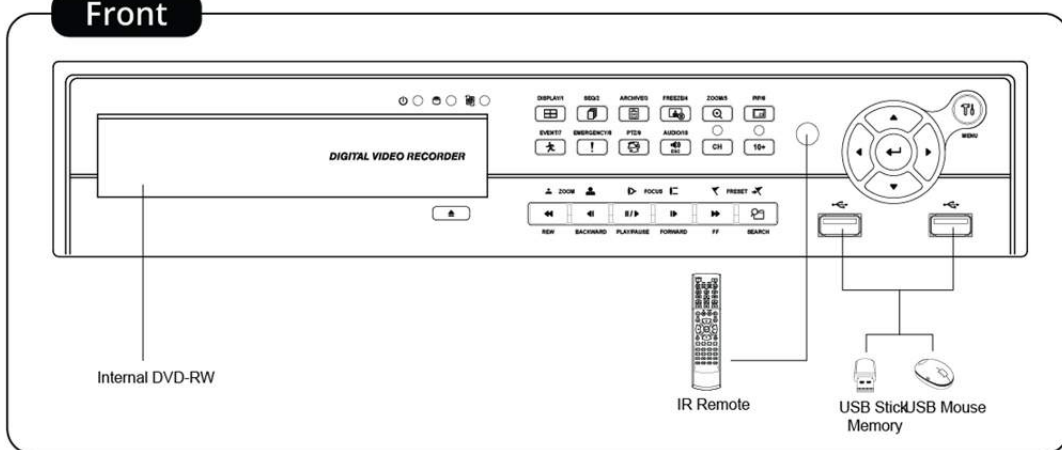

Rear

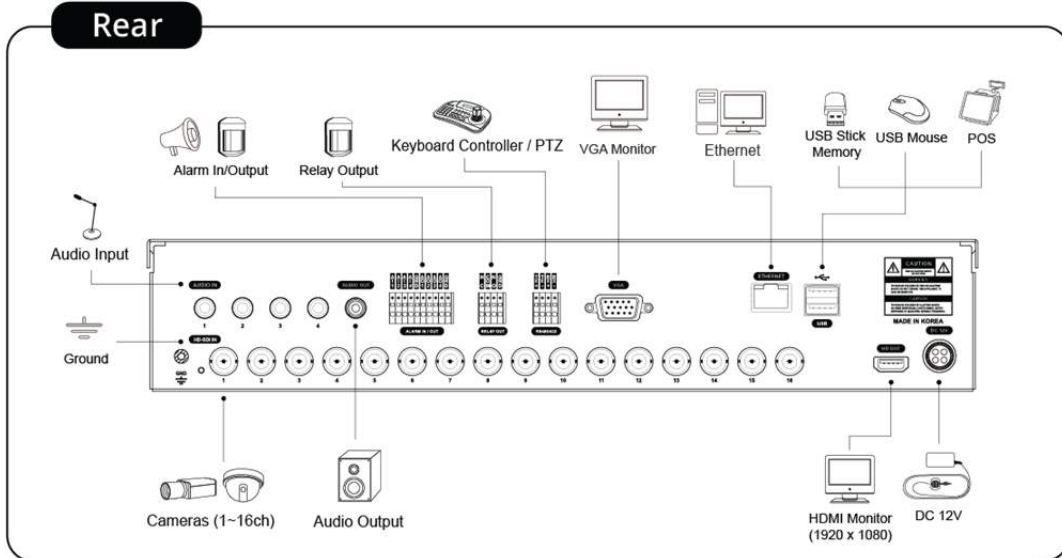

F Type – 4 / 8 / 16 channel Series HD-SDI DVR

Front

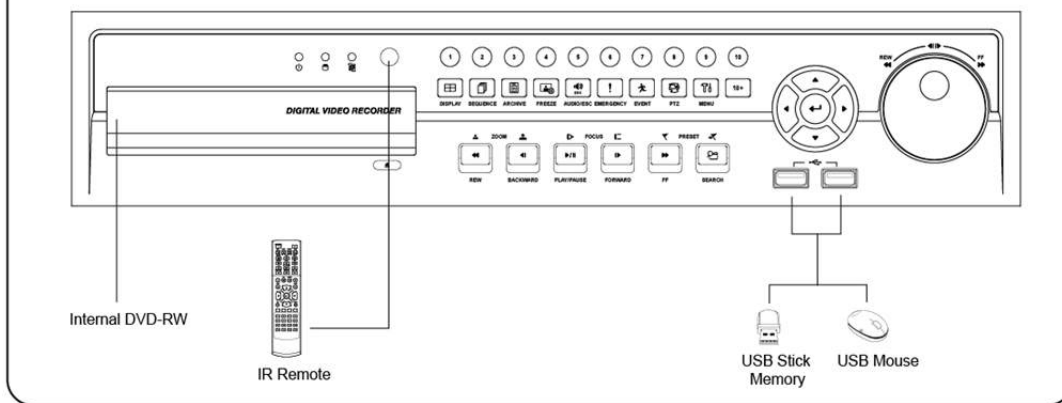

Rear

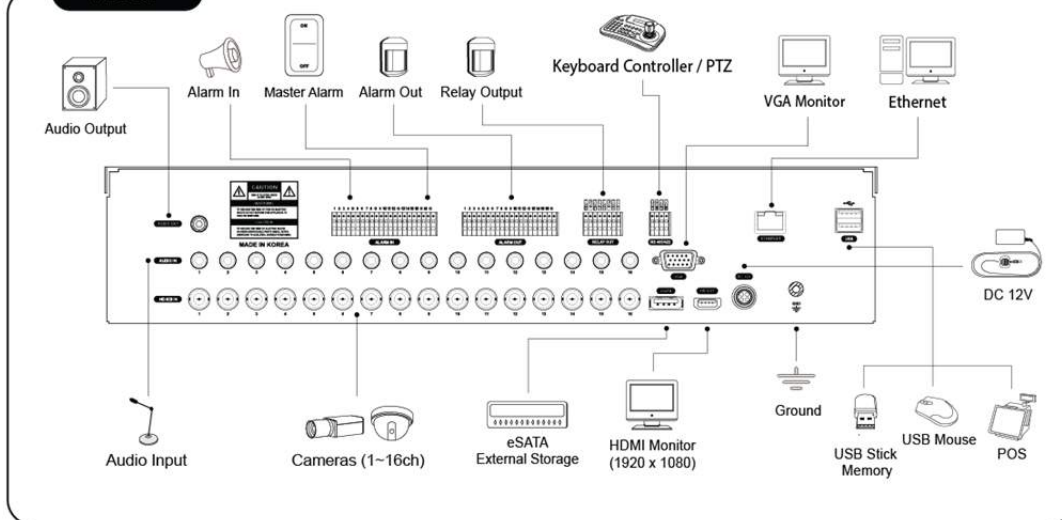

G Type – 4 channel Series HD-SDI DVR

Front

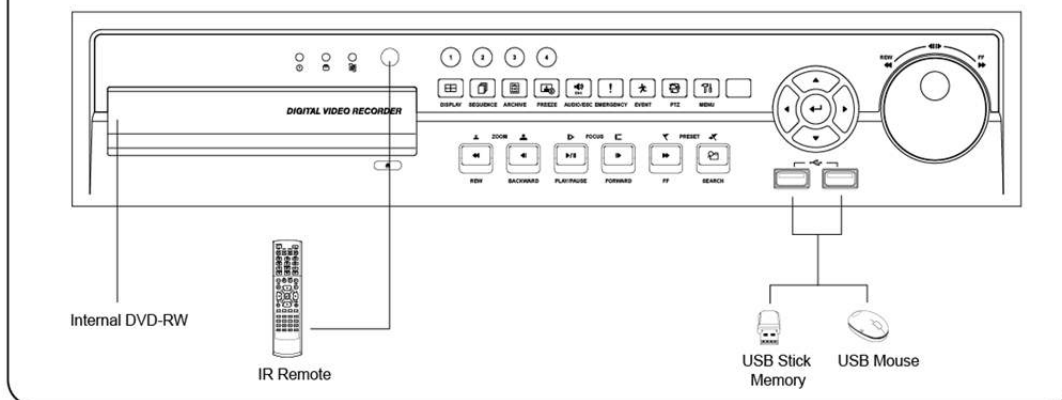

Rear

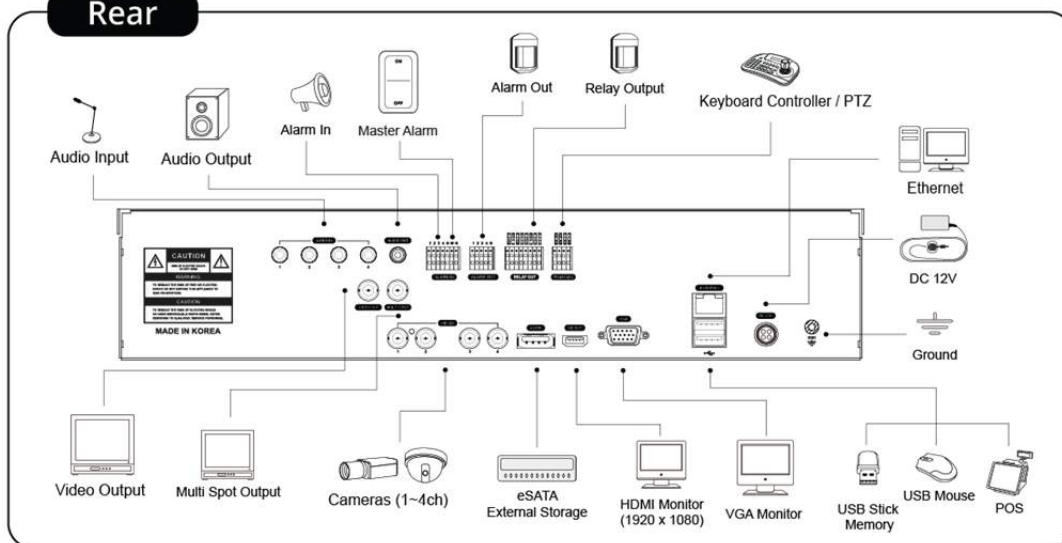

G Type – 8 / 16 channel Series HD-SDI DVR

Front

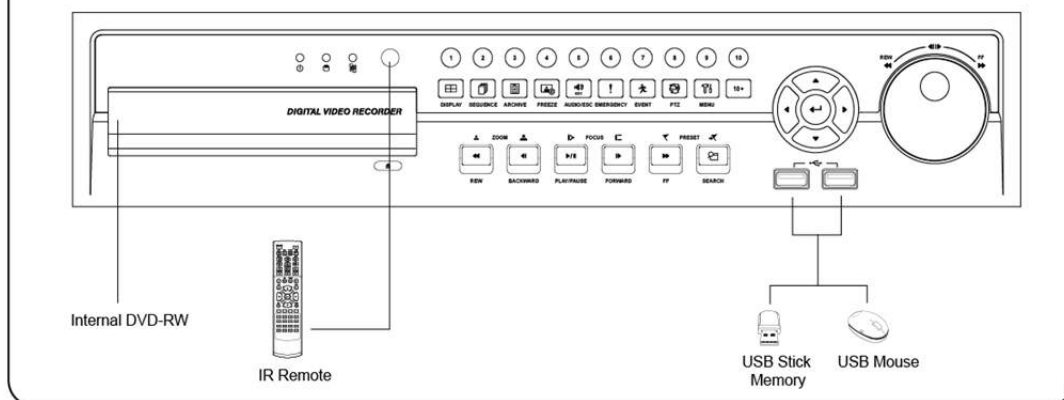

Rear

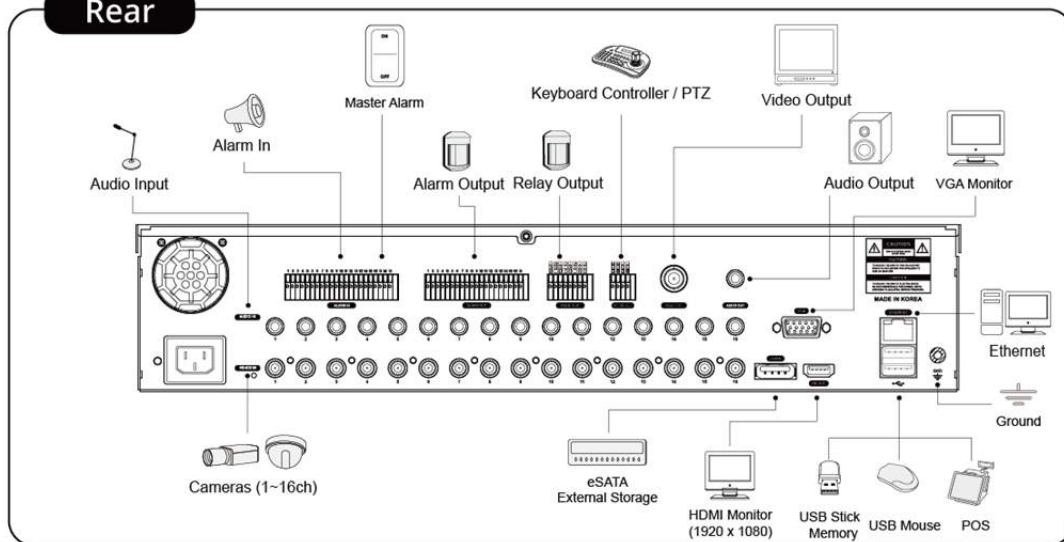

H Type – 4 channel Series HD-SDI DVR

Front

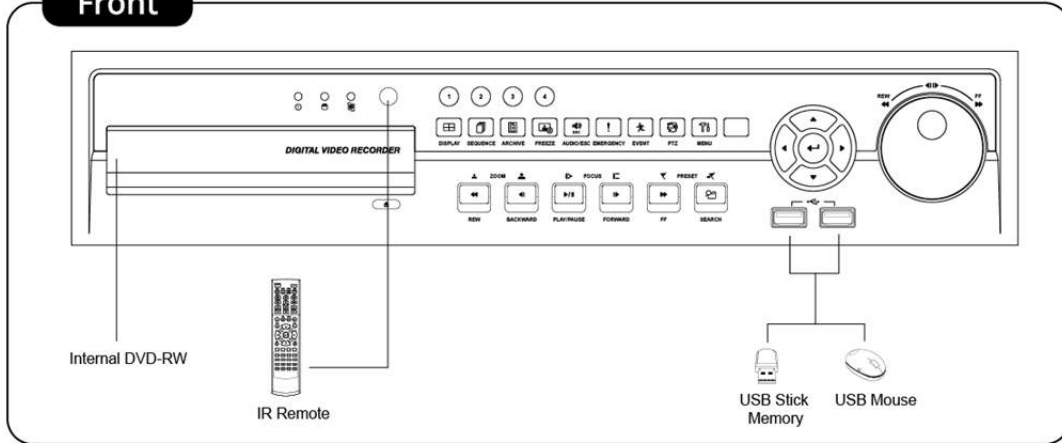

Rear

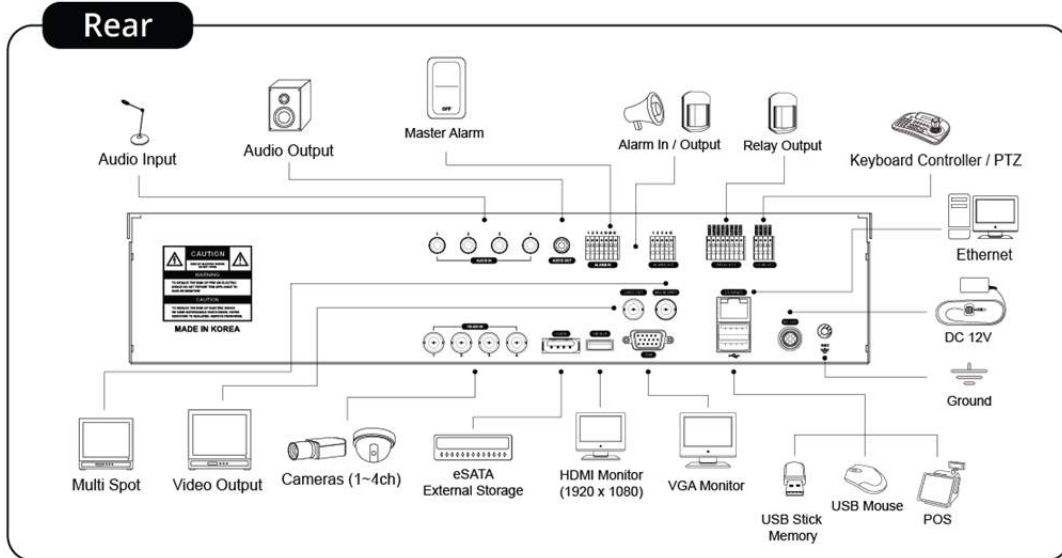

I Type – 4 + 4 / 4 + 12 channel Series Hybrid DVR

Front

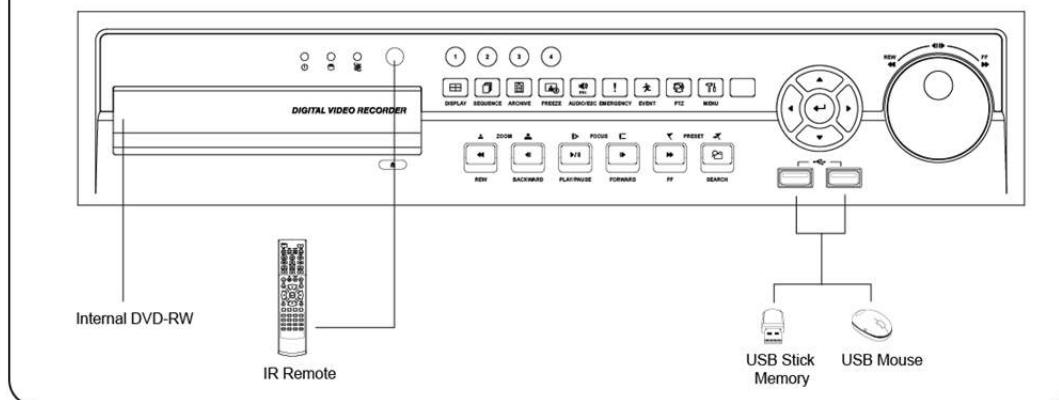

Rear

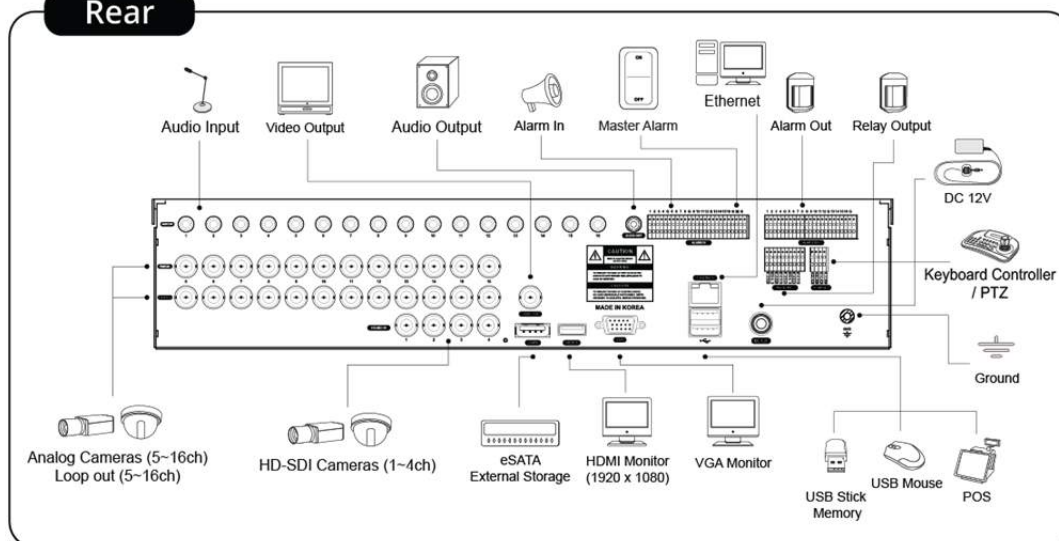

J Type – 8 / 16 channel Series True Hybrid DVR

Front

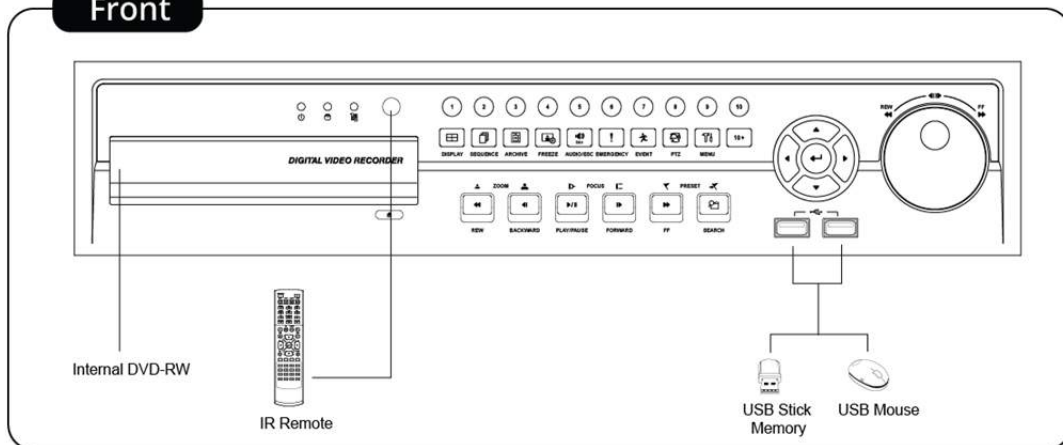

Rear

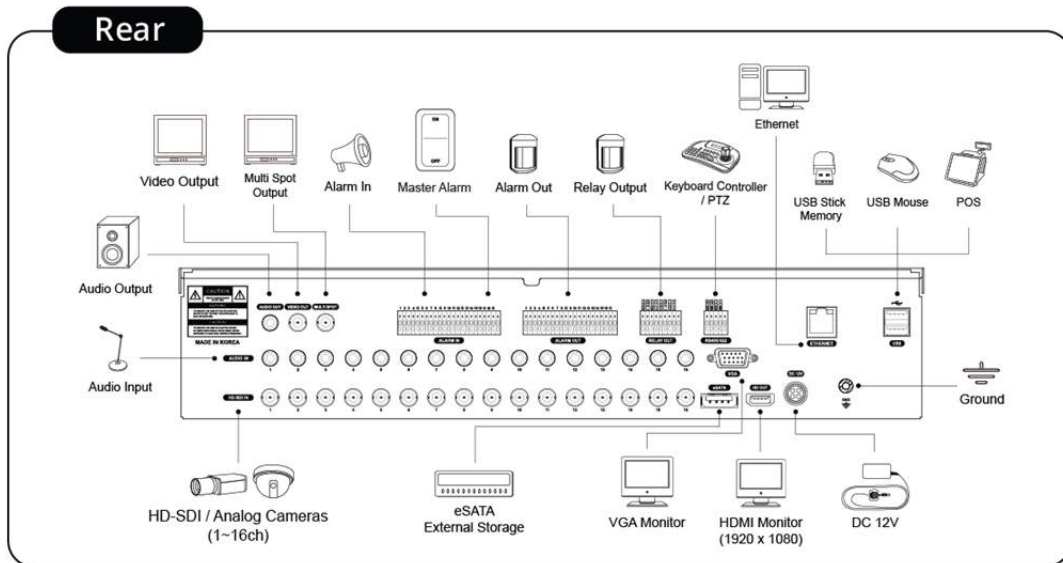

2. Installation

2.1 Hard disk and DVD-RW Installation

2.1.1 SATA Port

- When installing HDDs, make sure to connect from SATA 1 Port.
- **S and E (4CH) Type**
 - Main board of this DVR has one SATA port: it is indicated as SATA 1.
- **A Type**
 - Main board of this DVR has two SATA port: it is indicated as SATA 1 and 2.
- **B and E (8, 16CH) Type**
 - Main board of this DVR has three SATA port: it is indicated as SATA 1, 2 and 3.
 - Please mount DVD-RW at the **SATA 3 port**.
- **C, D, F, G, H, I and J Type**
 - Main board of this DVR has five SATA ports: they are indicated as SATA 1, 2, 3, 4 and SATA 5.
 - Please mount DVD-RW at the **SATA 5 port**.
- Up to five SATA devices (HDD and DVD-RW) are able to be connected to the SATA ports in serial; however the devices must be connected onto correct SATA port.
- Refer to the table below to mount HDDs and DVD-RW.

S and E (4CH) Type

4 / 8 CH DVR	Storage		SATA 1 Port	
	HDD			
	1		HDD	

A Type

4 / 8 / 16 CH DVR	Storage		SATA 1, 2 Port	
	HDD		1	2
	1		HDD	---
2		HDD	HDD	

B and E (8, 16CH) Type

4 / 8 / 16 CH DVR	Storage		SATA 1, 2, 3 Port		
	HDD	DVD-RW	1	2	3
	1	1	HDD	---	DVD-RW
	2	1	HDD	HDD	DVD-RW
2	0	HDD	HDD	---	

C, D, F, G, H, I and J (8, 16CH) Type

4 / 8 / 16 CH DVR	Storage		SATA 1, 2, 3, 4, 5 Port				
	HDD	DVD-RW	1	2	3	4	5
	1	1	HDD	---	---	---	DVD-RW
	2	1	HDD	HDD	---	---	DVD-RW
	3	1	HDD	HDD	HDD	---	DVD-RW
	4	1	HDD	HDD	HDD	HDD	DVD-RW
4	0	HDD	HDD	HDD	HDD	---	

2.1.2 Internal SATA Storage

- **C, D, F, G, H, I and J Type** DVR have 5 internal SATA Ports.
- 1-4 SATA Port: It is designed to mount HDD. Connect from SATA 1 port when installing HDDs.
- 5 SATA Port: Please mount a DVD-RW.
- Only one DVD-RW can be installed among the SATA Ports.

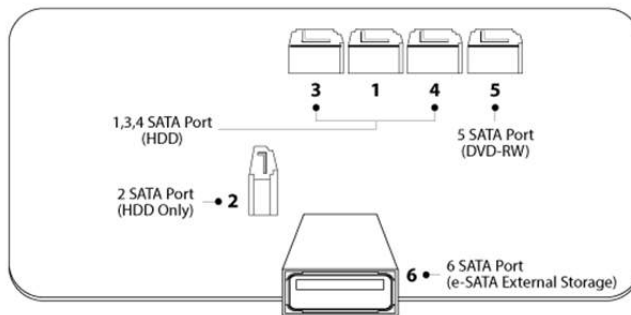

2.1.3 e-SATA External Storage (C, F, G, H, I and J Type)

- These series DVRs have one external SATA Port; the picture above shows external **SATA 6 Port**.
- 6 SATA Port: It is designed to mount up to 4HDDs per external SATA Port.

2.1.4 HDD Installation

- Securely mount a hard disk using bracket and screws provided.
- Please do not use any different hard disk cables (data cable and power supply cable) other than provided.
- Otherwise, it may cause damage to the hard disk.

CAUTION

INSTALL DVD-RW OR/AND HARD DISK AFTER DVR POWER OFF. OTHERWISE, IT MAY CAUSE PERMANENT DAMAGE TO THE HARD DISK. TO TURN OFF DVR, PLEASE USE SHUTDOWN KEY ON SYSTEM MUNU BAR LOCATED ON THE RIGHT MARGIN. AND THEN UNPLUG THE POWER CABLE FROM DVR.

2.1.5 HDD Capacity

- Each model has different HDD capacity.
- Below table shows the maximum HDD capacity for each model.

Type	S, E (4CH)	A~B	C~D	E (8, 16CH)	F~J
Capacity	3TB	6TB	12TB	6TB	12TB

2.1.6 DVD-RW Installation

- Securely mount DVD-RW using bracket and screws provided.
- Please do not use any different DVD-RW cables (data cable and power supply cable) other than provided.
- Otherwise, it may cause damage to the DVD-RW.
- Only one DVD-RW can be used. Mount it at the SATA 3 port (**B, and E (8, 16CH)**) and SATA 5 port (**C, D, F, G, H, I and J Type**).

CAUTION

INSTALL DVD-RW OR/AND HARD DISK AFTER DVR POWER OFF. OTHERWISE, IT MAY CAUSE PERMANENT DAMAGE TO THE HARD DISK. TO TURN OFF DVR, PLEASE USE SHUTDOWN KEY ON SYSTEM MUNU BAR LOCATED ON THE RIGHT MARGIN. AND THEN UNPLUG THE POWER CABLE FROM DVR. ALSO, WAIT FOR 5 SECONDS BEFORE PLUGGING IN POWER SUPPLY AGAIN.

2.2 Connector Wiring

2.2.1 Video-In/Loop Out Connections

S, A, B, C and D Type

- Connect Analog camera to 'VIDEO IN'.
- If a user wishes to link a camera input to another device, use 'LOOP OUT'. (**C and I Type**).
- Assure the 'VIDEO IN' (top connector) and 'LOOP OUT' (bottom one) connections are connected properly, not opposite way.

E, F, G and H Type

- Connect HD-SDI cameras to 'HD-SDI IN' from channel 1 to 16.

I Type

- Connect HD-SDI cameras to 'HD-SDI IN' from channel 1 to 4.
- Connect Analog cameras to 'VIDEO IN' from channel 5 to 16.

J Type (True Hybrid)

- Connect HD-SDI or Analog cameras to 'any' from channel 1 to 16.

NOTE

Only **C and I Type** model supports LOOP OUT connection.

NOTE

Please reboot the DVR, when switch from HD-SDI to Analog or Analog to HD-SDI (**J type only**)

2.2.2 HD-SDI Input Signal detection (E, F, G, H, I and J Type)

- These types of DVRs automatically detect the video signals of 720P 24, 720P 25, 720P 30, 720P 50, 720P 60, 1080i 50, 1080i 60, 1080P 24, 1080P 25, 1080P 30, 1080P 50, 1080P 60 (Auto Detection) when the system starts.
- 720P and 1080P HD-SDI inputs can be used simultaneously with no restriction.

NOTE

1080i input cannot be used simultaneously with 720P and/or 1080P and does not support digital zoom in live mode.
(**E (8, 16CH) and F (8, 16CH) Type**)

2.2.3 Monitor Connections (Video Out, VGA and Multi Spot)

- Video Out (**S, A, B, C, D, G, H, I and J Type Only**)
 - Use with the CCTV monitor.
 - Connect BNC cable between CCTV monitor and 'VIDEO OUT' of the DVR.
- VGA
 - Use with the computer monitor.
 - Connect VGA cable between computer monitor and 'VGA' of the DVR
- Spot (**S Type Only**)
 - This function supports one Channel Display on Spot Monitor
 - Connect BNC cable between spot monitor and spot port of rear panel.
- Multi Spot (**A, B, C, D, G (4 CH) and J Type Only**)
 - This function supports Multi-Channel Display on Spot Monitor
 - Connect BNC cable between spot monitor and multi spot port of rear panel.

CAUTION

BLACK SCREEN WILL DISPLAY IF THE MONITOR DOES NOT SUPPORT THE SELECTED RESOLUTION. IN ORDER TO CHANGE THE RESOLUTION PLEASE PRESS "REW>FF>BACKWARD>FORWARD" IN SERIES USING FRONT BUTTON OR REMOTE CONTROLLER THEN THE RESOLUTION WILL BE CHANGED TO '1024 X 768'.

2.2.4 HDMI connections

- Connect HDMI cable to HD out port of rear panel and HDMI port of HD output device.
- Please Click (←) **SETUP> DEVICE > DISPLAY > General** and the following screen will display.

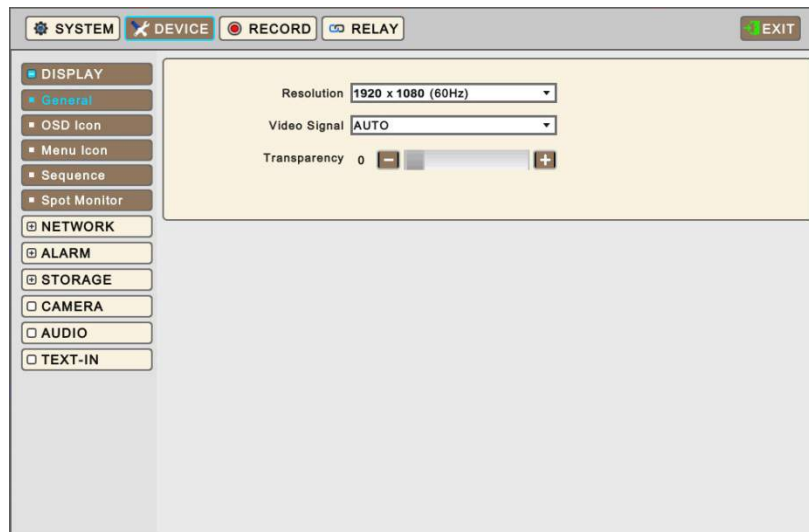

- Click the box below to select resolution.
 - A user can select the resolution among '1920x1080 (60Hz)', '1920x1080 (50Hz)', '1280x720 (60Hz)', '1280x720 (50Hz)' and '1024x768'.
 - If the resolution is changed then the DVR may restart automatically.
 - The default setting of DVR is '1920 x 1080 (60Hz)'.
- Click Video Signal box to select signal format.
 - A user can select the signal output among 'NTSC', 'PAL' and 'AUTO'.
 - The default setting of DVR is 'AUTO'

CAUTION

HDMI CONNECTION MAY NOT BE COMPATIBLE WITH CERTAIN OUTPUT DEVICE.
VIDEO NOISE MAY OCCUR DEPENDING ON THE TYPE OF HDMI CABLE USED. MAKE SURE TO USE AN HDMI-CERTIFIED CABLE.

CAUTION

BLACK SCREEN WILL DISPLAY IF THE MONITOR DOES NOT SUPPORT THE SELECTED RESOLUTION. IN ORDER TO CHANGE THE RESOLUTION PLEASE PRESS "REW>FF>BACKWARD>FORWARD" IN SERIES USING FRONT BUTTON OR REMOTE CONTROLLER THEN THE RESOLUTION WILL BE CHANGED TO '1024 X 768'.

2.2.5 Audio Connections

- Connect an audio device to '**AUDIO IN**' and a speaker system to '**AUDIO OUT**'. Please use a speaker system with volume adjustable.

2.2.6 TCP/IP (Ethernet) Connections

- Connect to '**ETHERNET**' connector with the LAN cable.
- When connect to Internet, use an ordinary LAN cable (Non-cross cable). However, when connect directly to a PC, please use only 'Crossover cable'.

2.2.7 Alarm Connections (TTL)

- Connect Alarm Input (Sensor) to 'AI 1~AI 4 (or AI 16)' connectors and connect Sensor Common to 'G' connector.
- Connect Alarm Output (buzzer, siren, etc.) to 'AO 1~AO 4 (or AO 16)' connectors and connect Common to 'G' connector. (Except **A and B** type)

2.2.8 Master Alarm (C, D, F, G, H, I and J Type)

- Alarm In sensor will be deactivated if Master Alarm is on.
- Connect Master Alarm In to 'M' connectors.

2.2.9 Alarm Connections [Relay (Dry Contact)] (Except S Type)

- Connect Alarm Output (buzzer, siren, etc.) to 'NO and/or NC' connectors, Power to 'COM' connector and Ground to 'GND' connector.

2.2.10 RS-485/422 Connections

- PTZ Camera and Keyboard controller connector.
- Please use TX+, TX-, RX+ and RX- terminals accordingly.

2.2.11 RS-485 Over Coax Connection (S, A, B, C, I and J Type)

- PTZ Camera Connector
- Please connect Coax to 'Video In' and select any Protocol in Camera/PTZ setup.

NOTE

PTZ Camera must support RS-485 over Coax function in order to use this feature.

NOTE

When selecting Protocol, a user can choose any protocol from the Protocol list other than 'NONE'. If 'NONE' is selected then RS-485 over Coax will not work.

2.2.12 USB Connections

- There are up to four identical USB ports in front and in rear. It is possible to connect a USB memory stick to archive data or a mouse to control the device.

2.2.13 Grounding (Earthing)

- Connection of ground wire is highly recommended to protect the DVR from external electric shock, such as lightning, electrical surge.

2.2.14 Factory Reset Switch

- Reset the switch to restore all setup values to factory default. It also deletes System Log File.
- The switch is located in a pin hole of the back panel.
- Using a paper clip, press and hold the reset switch for 2-3 seconds and release until popup message will display.

2.2.15 Power Supply connections

- **S Type:** Plug the power supply adapter (**DC 12V, 3A, included**) to 'DC12V' connector and plug another side to power source. Adapter input voltage is a free volt (100 VAC ~ 240 VAC). Please do not use any different power supply adapter because it may cause the DVR to malfunction.
- **A, B and E (4CH) Type:** Plug the power supply adapter (**DC 12V, 5A, included**) to 'DC12V' connector and plug another side to power source. Adapter input voltage is a free volt (100 VAC ~ 240 VAC). Please do not use any different power supply adapter because it may cause the DVR to malfunction.
- **C, D, E (8, 16CH), F, G (4CH) H, I and J Type:** Plug the power supply adapter (**DC 12V, 6.67A, included**) to 'DC12V' connector and plug another side to power source. Adapter input voltage is a free volt (100 VAC ~ 240 VAC). Please do not use any different power supply adapter because it may cause the DVR to malfunction.
- **G (8 / 16CH) Type:** Plug the power source. Products input voltage is a free volt (100 VAC ~ 240 VAC).
- Please do not use any different power supply adapter because it may cause the DVR to malfunction.























2.2.16 Connections Guideline

- **Video out Connector:** If only the monitor is connected to VIDEO OUT connector, please set the impedance switch on the rear side of the monitor to 75 ohms to prevent abnormally bright or collapsed images. If wish to connect another device (e.g., a recorder) to the back of the monitor, please set the impedance switch on the rear side of the monitor to HIGH Z (High Impedance) and set the last device to 75 ohms.
- **Alarm Input Connector:** Do not input any type of voltage to the AI 1~AI4 (AI 16) connectors.













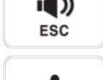

3. Input Device and Screen Icons

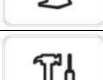
3.1 Key and LEDs

B and E (8, 16CH) Type

KEYS	PTZ KEY	Operating mode	Setup mode
▲, ▼, ◀, ▶		• Control Pan/Tilt rotation of up/down/left/right in PTZ mode	• Up/Down/Left/Right on screen cursor control
MENU		• Enter the Main Menu (Setup mode)	
DISPLAY		• Select 1/4/8/9/10/16 channel display.	
SEQUENCE		• Channel sequence mode on/off (Main Monitor)	
ARCHIVE		• Copy video data into the external storage device	
FREEZE		• Screen freeze mode on/off	
Zoom		N/A	
PIP		• Picture In Picture display on	
EVENT		• System Log display on	
EMERGENCY		• Emergency recording on	
PTZ		• Pan/Tilt/Zoom control mode on/off	
AUDIO/ESC		• Audio on/off on selected channel (Live View). • ESC (Menu)	
1 ~ 10		• Camera select keys : (4/8 channel DVR)	
11 ~ 16		• Camera select keys : (16 channel DVR)	
REW		• Fast backward playback (changes up to x128 with each press) • Zoom-Out on PTZ mode	
BACKWARD		• Frame backward playback • Zoom-In on PTZ mode	
PLAY/PAUSE		• Viewing mode: Instant playback (playback the recorded video from the last three minutes) • Playback mode: 1X PLAY/PAUSE • Focus Near in PTZ mode	
FORWARD		• Frame forward playback • Focus Far in PTZ mode	
FF		• Fast forward playback (changes up to x128 with each press) • Save Preset in PTZ mode	
SEARCH		• Video search mode on • Go to Preset in PTZ mode	
Power LED (Red)		• Light off: DVR off • Light on: DVR on	
HDD LED (Green)		• Light off: Standby Reading/Writing • Blink : DATA Reading/Writing	
Network LED (Yellow)		• Light off: No Devices are connecting to DVR through network (No User access) • Light On: Devices are Connecting to DVR through network (User access)	

C, D, F, G, H, I and J Type

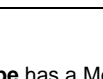
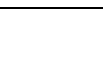
KEYS	PTZ KEY	Operating mode	Setup mode
▲, ▼, ◀, ▶		• Control Pan/Tilt rotation of up/down/left/right in PTZ mode	• Up/Down/Left/Right on screen cursor control
1 ~ 10 / 10+		• Camera select keys : (4/8/16 channel DVR)	
DISPLAY		• Select 1/4/8/9/10/16 channel display.	
SEQUENCE		• Channel sequence mode on/off (Main Monitor)	
ARCHIVE		• Copy video data into the external storage device	
FREEZE		• Screen freeze mode on/off	
AUDIO/ESC		• Audio on/off on selected channel (Live View). • ESC (Menu)	• EXIT
EMERGENCY		• Emergency recording on	
EVENT		• System Log display on	
PTZ		• Pan/Tilt/Zoom control mode on/off	
MENU		• Enter the Main Menu (Setup mode)	
REW		• Fast backward playback (changes up to x128 with each press) • Zoom-Out on PTZ mode	
BACKWARD		• Frame backward playback • Zoom-In on PTZ mode	
PLAY/PAUSE		• Viewing mode: Instant playback (playback the recorded video from the last three minutes) • Playback mode: 1X PLAY/PAUSE • Focus Near in PTZ mode	
FORWARD		• Frame forward playback • Focus Far in PTZ mode	
FF		• Fast forward playback (changes up to x128 with each press) • Save Preset in PTZ mode	
SEARCH		• Video search mode on • Go to Preset in PTZ mode	
Power LED (Red)		• Light off: DVR off • Light on: DVR on	
HDD LED (Green)		• Light off: Standby Reading/Writing • Blink : DATA Reading/Writing	
Network LED (Yellow)		• Light off: No Devices are connecting to DVR through network (No User access) • Light On: Devices are Connecting to DVR through network (User access)	

NOTE

S, A and E (4CH) Type has a Menu key and direction keys in the front.

3.2 Camera Select Keys for 16 Channel DVR

B and E (8, 16CH) Type



- Below shows how to select camera channel for 4 channel DVR
 - Select Camera No. 1~4: press **CH** key and use **1~4** key
- Below shows how to select camera channel for 8channel DVR
 - Select Camera No. 1~8 press **CH** key and use **1~8**key
- Below shows how to select camera channel for 16channel DVR
 - Select Camera No. 10~16: press **CH** key and use **10+**, **1~6** key

C, D, F, G, H, I and J (8, 16CH) Type

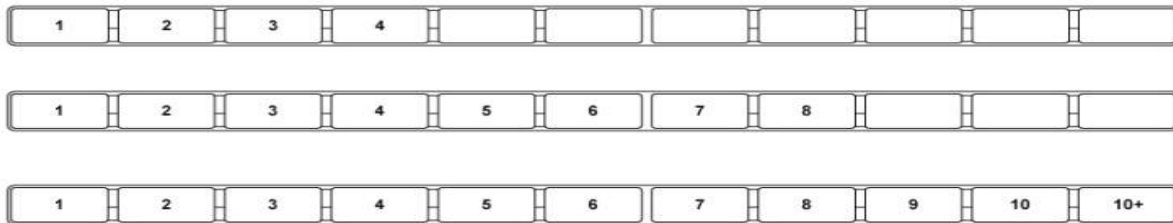

- Below shows how to select camera channel for 16 channel DVR
 - Select Camera No. 1~10: use **1~10** direction key
 - Select Camera No. 11~16: press **10+** key and use **1~6** direction key

3.3 Front Panel

S (4, 8CH), A, E (4CH) Type

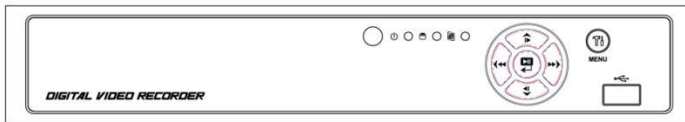

4 / 8 / 16 Channel DVR

B and E (8, 16CH) Type

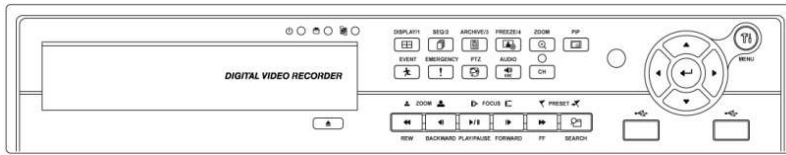

4 Channel DVR

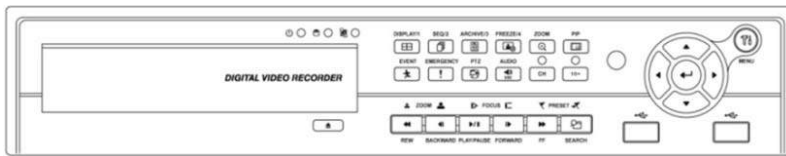

8 Channel DVR

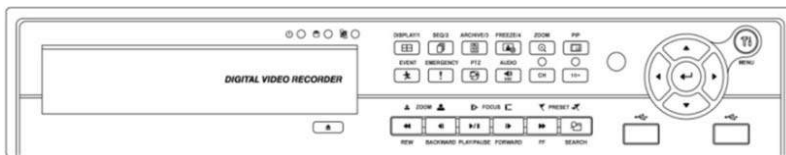

16 Channel DVR

C, D, F, G, H, I and J (8, 16CH) Type

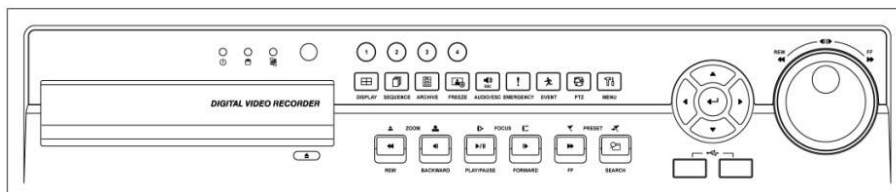

4 Channel DVR

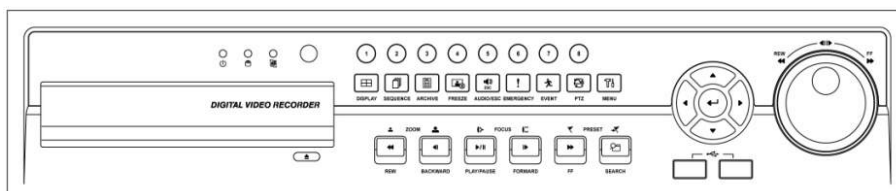

8 Channel DVR

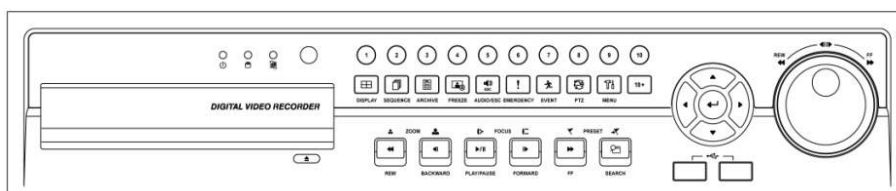

16 Channel DVR

3.4 Using a Remote Controller

- Usage of a remote controller is same as the front panel keys.
- Follow the procedure below when you use one remote controller for multi DVRs.
 - ① Check System ID (e.g., between 1 and 255) of the DVR that wish to use.
 - (SETUP>SYSTEM>Status>General or Status window).
 - ② ID Setup: Holding up the remote controller to face towards the DVR and press the System ID numbers one by one, while pressing ID button on the remote controller. The System ID is a **3-digit number**. Button '10' functions the same as '0'.
 - (e.g.: If System ID is 3, press 10>10>3 buttons in sequence while pressing the ID button)

3.5 Using a Mouse

- Mouse provides an easier access to adjustment. Refer to below for proper use.
- Left mouse button functions the same as **Enter** (↵) key on the front panel of DVR.
- Right mouse button displays the channel function key such as Audio, PTZ, PIP, Color and Position on selected channel.

S, A, B, C and D Type

Name of Key	Function
Audio	Enable/Disable Audio
Color	Change Brightness / Contrast / Saturation of the selected channel. (When supported)
PTZ	Enable/Disable PTZ control
PIP	Picture in Picture function
Position	Change the position of the each channel.

E (4CH), F (4CH), G, H and I Type

Name of Key	Function
Audio	Enable/Disable Audio
PTZ	Enable/Disable PTZ control
PIP	Picture in Picture function



























E (8, 16CH) and F (8, 16CH) Type

Name of Key	Function
Audio	Enable/Disable Audio
PTZ	Enable/Disable PTZ control

J Type

Name of Key	Function
Audio	Enable/Disable Audio
Color	Change Brightness / Contrast / Saturation of the selected channel. (When supported)
PTZ	Enable/Disable PTZ control
Position (Analog Input)	Change the position of the each channel.

3.6 Screen Icon

Icon	Description	Icon	Description
	Continuous recording schedule		Continuous + Motion recording schedule
	Motion recording schedule		Motion + Alarm recording schedule
	Alarm recording schedule		Cont. + Motion + Alarm recording schedule
	Continuous + Alarm recording schedule		No Record
	Continuous recording mode		Motion recording mode
	Alarm recording mode		Emergency recording mode
	Audio recording (When connected)		PTZ registration
	Recording in progress		Remote access indication/ No. of connected users (up to 16)
	In channel sequencing		Audio channel
	Master Alarm Overwritten		Date / Time
	HDD Overwriting Enabled		HDD Overwriting Disabled (Recording)
	Estimated HDD usage		Keyboard controller mode
	PTZ mode		Spot out Enabled
	Key Locked		

4. Setup

4.1 Login

- For security purpose, a user has to input the password to enter the setup menu.

- Please press  from Display Menu Bar to enter the setup menu and the following screen will display.



The login dialog box has a title bar with a green checkmark and the word "Login". It contains a "User ID" dropdown menu with "admin" selected, a "Password" text input field with a password icon, and "OK" and "Cancel" buttons at the bottom.

- In order to use all functions and privileges, log in as ID: admin.
- Default Password is "1111".
- After login successfully, following screen will display.

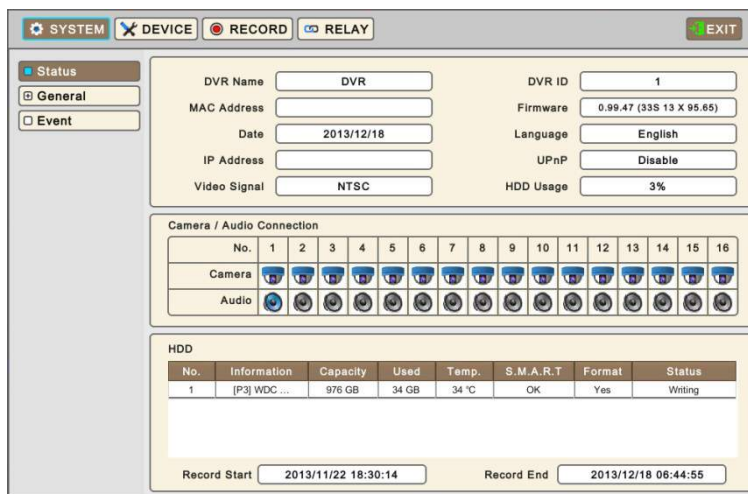

The main setup menu has a top navigation bar with "SYSTEM", "DEVICE", "RECORD", and "RELAY" buttons, and an "EXIT" button. A left sidebar shows "Status", "General", and "Event" options. The main area displays system information:

- DVR Name: DVR, DVR ID: 1
- MAC Address: [empty], Firmware: 0.99.47 (33S 13 X 95.65)
- Date: 2013/12/18, Language: English
- IP Address: [empty], UPnP: Disable
- Video Signal: NTSC, HDD Usage: 3%

Below is a "Camera / Audio Connection" table with 16 columns (No. 1-16) and rows for Camera and Audio.

No.	1	2	3	4	5	6	7	8	9	10	11	12	13	14	15	16
Camera	[icon]	[icon]	[icon]	[icon]	[icon]	[icon]	[icon]	[icon]	[icon]	[icon]	[icon]	[icon]	[icon]	[icon]	[icon]	[icon]
Audio	[icon]	[icon]	[icon]	[icon]	[icon]	[icon]	[icon]	[icon]	[icon]	[icon]	[icon]	[icon]	[icon]	[icon]	[icon]	[icon]

Below is an "HDD" table:

No.	Information	Capacity	Used	Temp.	S.M.A.R.T	Format	Status
1	[P3] WDC ...	976 GB	34 GB	34 °C	OK	Yes	Writing

At the bottom, "Record Start" is 2013/11/22 18:30:14 and "Record End" is 2013/12/18 06:44:55.

- Main menu consists of 4 sub menu.
 - **SYSTEM / DEVICES / RECORD / RELAY**
- To escape from the setup menu and save settings of DVRs, please Click Exit button on the screen.
- A user may use ◀, ▶ direction keys or mouse Click to exit from Setup. Please Click (↵) the EXIT button on the screen.

NOTE

Press AUDIO/ESC in the setup screen. It operates like CANCEL (ESC). During live mode, AUDIO/ESC button operates as on/off of audio (focused channel) and playback mode, it operates like EXIT from playback mode or CLOSE (if any popup existing.)

NOTE

Recording does NOT stop by menu accesses.

4.2 SYSTEM

4.2.1 Status

- Entering Setup Menu following screen will display.

No.	Information	Capacity	Used	Temp.	S.M.A.R.T	Format	Status
1	[P3] WDC ...	976 GB	34 GB	34 °C	OK	Yes	Writing

- System Status show information of the DVR like followings

- DVR name
- DVR ID
- MAC Address
- Firmware
- Date
- Language
- IP Address
- UPnP
- Video Signal
- HDD Usage
- Camera / Audio Connection
- HDD information
- Record Start & End time

NOTE

Values cannot be changed at 'Status'. Please see 'General' to change the value.

4.2.2 General



- Please Click (←) **SYSTEM>General** and the following screen will display.

Setup

DVR Name

- Name your DVR on your own.
- Please Click (↔) keyboard icon on DVR Name box and the following virtual keyboard will display.





- Please Click (↔) desired letters (characters) on the virtual keyboard to input.
 - ①  Use to erase one character every time.
 - ②  Use to erase the whole line.
 - ③  Use to move the cursor (Also you can use a mouse to move the cursor between characters)
- Please choose 'OK' to confirm the input and choose 'Cancel' to cancel.

DVR ID

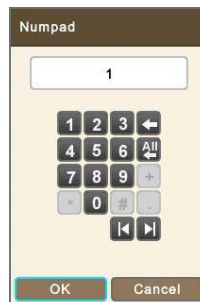
- Assign a unique ID for each DVR when you have multiple DVRs in a location.
- The unique ID is necessary with Remote Controller and/or Joystick operations.
- Please Click (↔)  on DVR ID box and the following virtual Numpad will display



- Take any whole number **between 1 and 255**.
- Please Click (↔) desired numbers on the virtual Numpad to input.
 - ①  Use to erase one number every time.
 - ②  Use to erase the whole numbers.
 - ③  Use to move the cursor (Also you can use a mouse to move the cursor between numbers)
- Please choose 'OK' to confirm the input and choose 'Cancel' to cancel.

Date Format

- Set date display format. Please Click (↔) Drop-down list of Date Format to select a format.

Time Format

- Set time display format. Please Click (↔) Drop-down list of Time Format to select a format.

Language

- Set menu display Language. Please Click (↔) Drop-down list of Language to select a language.

Setup

- **Import:** Copy a DVR configuration file stored in USB memory stick to DVR. Please plug in the memory stick and then Click (↔)

Import

– Please choose 'OK' to confirm and choose 'Cancel' to cancel.

- **Export:** Store the Menu setup of DVR to USB memory stick. Please plug in the memory stick and then Click (↔)

Export

- **Default:** Click (↔) **Default** to restore all setup values to default settings

– Please choose 'OK' to confirm and choose 'Cancel' to cancel.

NOTE

Import or Default process may restart the DVR.

Date / Time

- Adjust the current Date and Time of the DVR.
- Click Date/Time Button on the right hand side and following virtual calendar will display.



- Please follow the procedure below for date adjustment.
 - ① Use arrow buttons in the Month Calendar to select Year, Month and Day.
 - ►►: Move to next 'Year'
 - ◀◀: Move to previous 'Year'
 - ►: Move to next 'Month'
 - ◀: Move to previous 'Month'
 - ② Click (↔) a date. The date will be displayed in blue color.
- Please follow the procedure below for time adjustment.
 - ① Click (↔) items (AM/PM, H, M, S) to change. A selected item will be highlighted in a box
 - ② Adjust the number by Clicking (↔) ▲, ▼ buttons on the right-hand side.
 - ③ Repeat the same procedure to change AM/PM, H, M and S.
- Please choose 'OK' to confirm the adjusted date and time, choose 'Cancel' to cancel.

CAUTION

IF ADJUSTED DATE/TIME IS PRIOR TO RECORDED DATA, DATA AFTER NEW DATE/TIME MAY BE ERASED.

NOTE

It is strongly recommended to do 'Clear All Data' (SETUP>DEVICE>Storage>HDD Format)

NTP Server

- Adjust the NTP (Network Time Protocol, automatic time sync.) Server address and Check Interval when NTP is being used.
- Click (↔) **NTP Setup** on the right hand side and following window will display.



- Please Click (↔) Select box next to Check NTP Server in Interval to sync the time regularly by selected interval.
- **NTP Server:** Click (↔)  or address in NTP Server box and the virtual keyboard will display. Input IP address of NTP server
- **Check Interval:** Set clock-update-interval from NTP Server. A user can adjust time every 1 to 24 hours.
- Please choose 'OK' to confirm the NTP setup, choose 'Cancel' to cancel.

NOTE

Check the box next to  to connect Time Zone setting with NTP Server. A user should set the Time zone correctly to operate the NTP function properly.

NOTE

Currently used NTP is administered by **pool.ntp.org**. However, users are allowed to use IP address of any NTP site. (If they have their own, otherwise leave the default Serve name.)

Time Zone

- Please Click (↔) Drop-down list of Time Zone to select correct time zone.

NTP Time

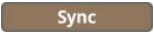
- Display NTP Server time, if Internet is connected to Time Server. If not displaying, please Click (↔) .
- When NTP Time's Clock is displayed, please Click (↔)  to synchronize NTP Server's clock with DVR clock.

NOTE

The displayed Server Time could be 30 minutes or 1 hour off from actual local time when the region is on Daylight Saving Time period. Just disregard it and sync the time. When you proceed to 'EXIT'. The very correct time should have been applied and displayed on DVR's screen.

DST

- Please Click (↔) Select box of DST to use Daylight Saving Time or not.
- If DST is (if different DST rule is) observed, please Click (↔)  and the following screen will display.

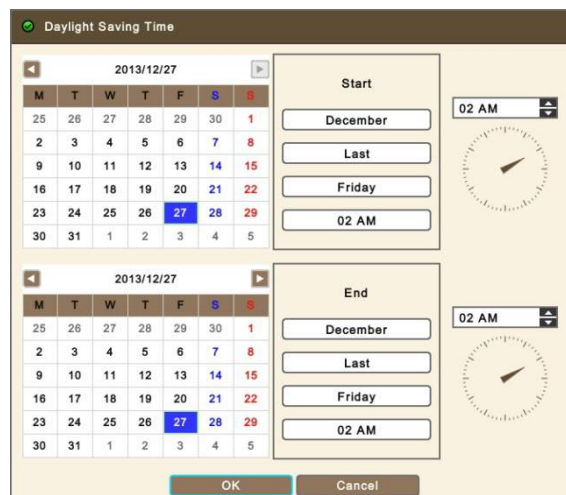

- Adjust the dates of Start and End for DST
- Please follow the procedure below for date adjustment. (Start & End)
 - ① Use arrow buttons in the Month Calendar to select date.
 - ▶: Move to next 'Month'
 - ◀: Move to previous 'Month'
 - ② Click (↔) a date. The date will be displayed in blue color
- Please follow the procedure below for time adjustment. (Start & End)
 - ① Adjust the number by Clicking (↔) ▲, ▼ buttons on the right-hand side.
- Please choose 'OK' to confirm the adjusted date and time, choose 'Cancel' to cancel.

Firmware

- Users may upgrade DVR when it is required.
- Please follow the Upgrade process below.
 - ① Plug USB memory stick which has a proper firmware file.
 - ② Click (↔) **Load New** Then, software version stored in the USB will display on the left-hand side.
 - ③ Click (↔) **Apply** to start the upgrade.
 - ④ Popup message box will display and ask to proceed. Click 'OK' to proceed.
 - ⑤ When the upgrade is completed, a message box will display. Please Click 'OK' button and DVR will auto-reboot.

NOTE

Upgrade file must be placed inside USB without folder. Otherwise SYSTEM will not be able to recognize the file.

CAUTION

DO NOT UPGRADE UNTIL A HARD DISK DRIVE IS INSTALLED. MAKE SURE TO UPGRADE WHEN HDD IS IN PROPER OPERATION.

CAUTION

PLUGGING OUT USB DEVICE OR FORCED POWER-OFF DURING VERSION UPGRADE MAY CAUSE PERMANENT DAMAGE.

Account

Group

- Please Click (↔) **New Group** and the following screen will display.



- Click (↔)  on the right-hand side of Group Name box or Group Name box. Then, the virtual keyboard will display.
- Please Click (↔) desired characters (up to 60 letters) on the virtual keyboard.
- Select access rights for the Group by checking some of the following items (All, Setup, Archiving, Shutdown, Search, Network, and Reboot). If Click (↔) 'All', all items are checked/unchecked at once.
- Please choose 'OK' to confirm the settings, choose 'Cancel' to cancel.
- To Edit the Group, Select a Group from the list and Click (↔) **Edit**
- To Delete the Group, Select a Group from the list and Click (↔) **Delete**

USER

- Please Click (↔) **New User** and the following screen will display.



- Click (↔) Drop-down list of Group Name to select a group
- Click (↔)  on the right-hand side of User ID frame or User ID box then virtual keyboard will display.
- Please Click (↔) desired characteristics (up to 60 letters) on the virtual keyboard.
- Input Password, Confirm and E-mail.
- Please choose 'OK' to confirm the settings, choose 'Cancel' to cancel.

- Then, lists of User will show as follows.

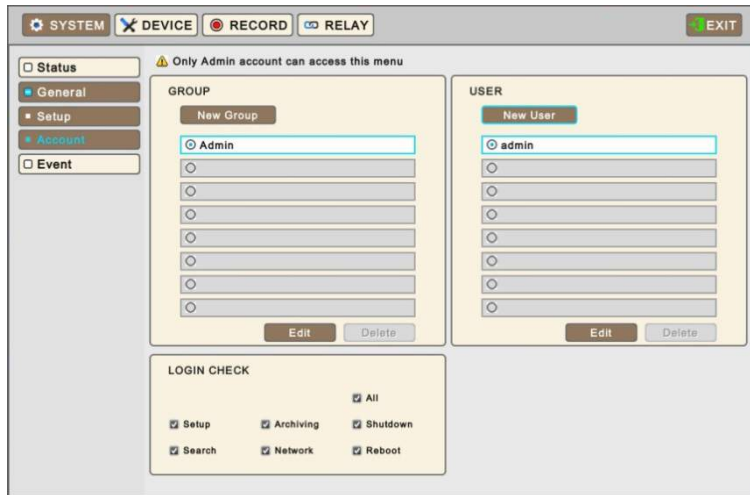

- To Edit the User, Select a User from the list and Click (↔) **Edit**
- To Delete the User, Select a User from the list and Click (↔) **Delete**

NOTE
Only 'Admin user' can access Account menu.

NOTE
E-mail address is not mandatory to create New User but it is necessary to send email notification.

NOTE
A user may create up to 8 Groups and 8 Users per Group.

Login Check

- Selectively enable password protection for important operations.
- Please check the operations that wish to enable password protection.

CAUTION
USERS WILL NOT BE ASKED TO ENTER THE PASSWORD FOR OPERATION(S) WHEN PASSWORD PROTECTION IS NOT ACTIVATED.

4.2.3 Event

- Please Click (↔) **SYSTEM>Event** and the following screen will display.

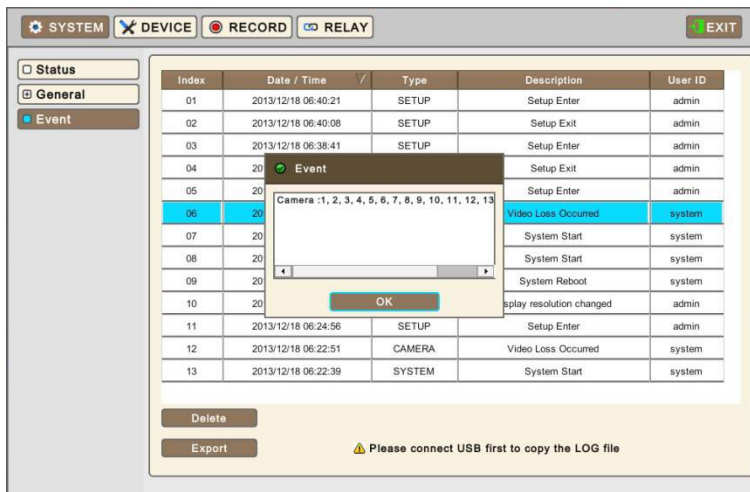

- System Log shows various event logs by User ID(s) like below
 - System Start
 - System Reboot
 - Setup Default/Import/Export
 - Resolution Change
 - Video out Change
 - Time Adjust Before/After
 - NTP Sync Success/Fail
 - Firmware Upgrade Success/Failure
 - Log Delete/Export
 - Setup Enter/Exit
 - Playback Start/Exit
 - Archive Success/Failure/Cancel
 - Video Loss Occur
 - Network Connect/Disconnect
 - Setup Change from Remote
 - E-mail Send Success/Failure
 - HDD Add/Remove/Relocate
 - HDD Format Success/Failure
 - Data Clear Success/Failure
 - S.M.A.R.T check Bad
 - HDD Rec Day On/Off
 - HDD Overwrite On/Off
 - DST On/Off
 - Lock On/Off
- Click (↔) Delete box to delete the log contents
- Click (↔) Export box to Export the log contents to USB memory stick.

NOTE
 Maximum of 2,000 Event Log can be saved. After 2000 logs; older log will be deleted automatically.

NOTE
 Users are able to sort the Event Log by Date/Time, Type, Description and User.

NOTE
 Only Admin access right can delete the Log.

4.3 DEVICE

4.3.1 Display

- Please Click (←) **DEVICE>Display** and the following screen will display.

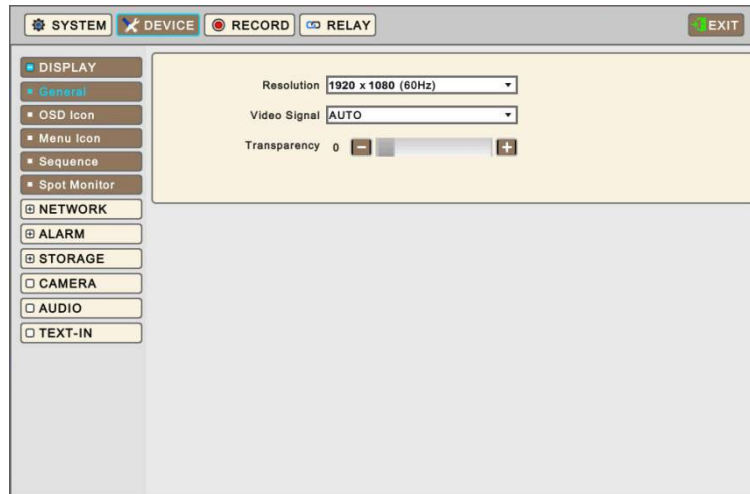

General

- Users are able to set its video output resolution between 1024 x 768 ~ 1920 x 1080.
- Video In / Out will help users to select its video input and output between NTSC, PAL and AUTO.
- The default value is 'AUTO'.
- Once the setting is changed, it will ask to reboot for the new recognition of video out.

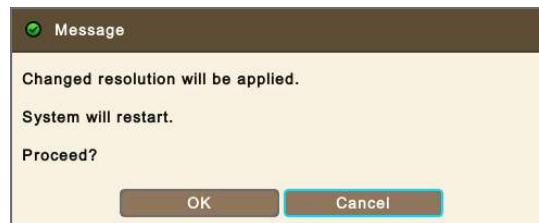

- Transparency option allows a user to adjust a level of transparency of menu display. Press (+) or (-) button to adjust the transparency

OSD Icon

- Please Click (←) **OSD Icon** and the following screen will display.

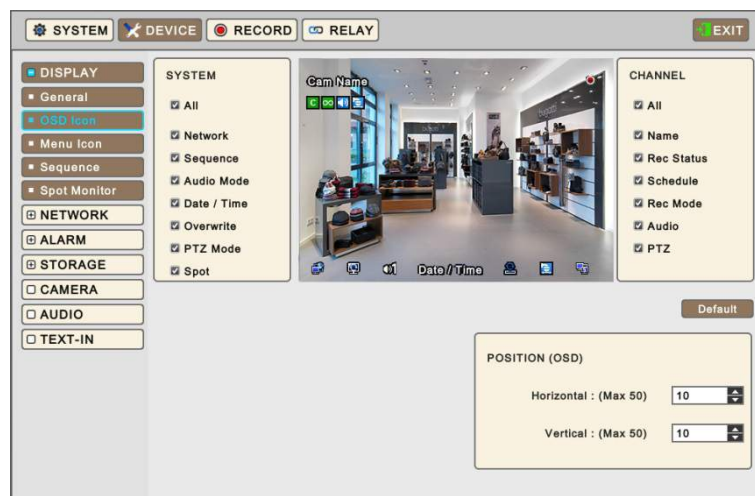

- The OSD Icon menu allows a user to select what to display on the screen.
- Click (←) **Default** to restore default value. (display all)

Position (OSD)

- Position (OSD) menu allows a user to adjust the position of Channel OSD on the monitor. Use it when some letters are dropped/invisible/blocked on the monitor.
- Adjust Horizontal to change margin between both ends of the monitor on horizontal side and OSD. Margin range is between **0 and 50**, with a larger number representing greater margin.
 - Use ▲, ▼ to adjust position of OSD
- Adjust Vertical to change margin between both ends of the monitor on vertical side and OSD. Margin range is between **0 and 50**, with a larger number representing greater margin.
 - Use ▲, ▼ to adjust position of OSD

Menu Icon

- Please Click (←) **Menu Icon** and the following screen will display.

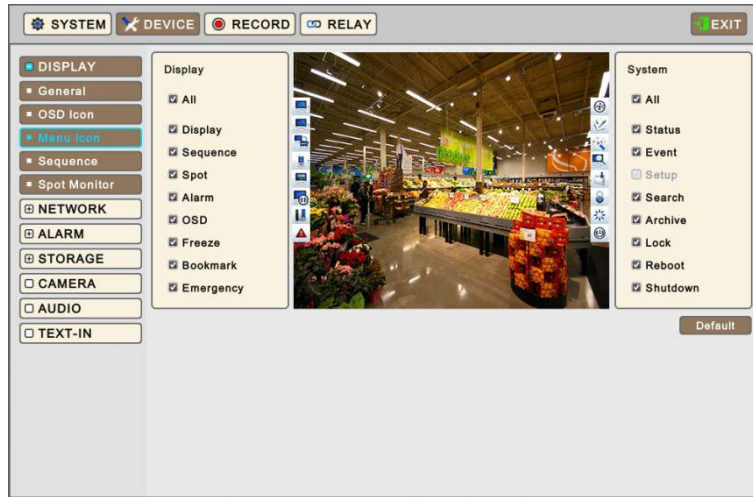

- The Menu Icon menu allows a user to customize the Left and Right side popup menu which is displayed on the screen by moving a mouse pointer on each side.
- Left side popup menu is for 'Display' options and Right side popup is for 'System' options. Click (←) 'All' selects/deselects all sub options.
- Click (←) **Default** to restore default value.

Sequence

- Please Click (←) **Sequence** and the following screen will display.

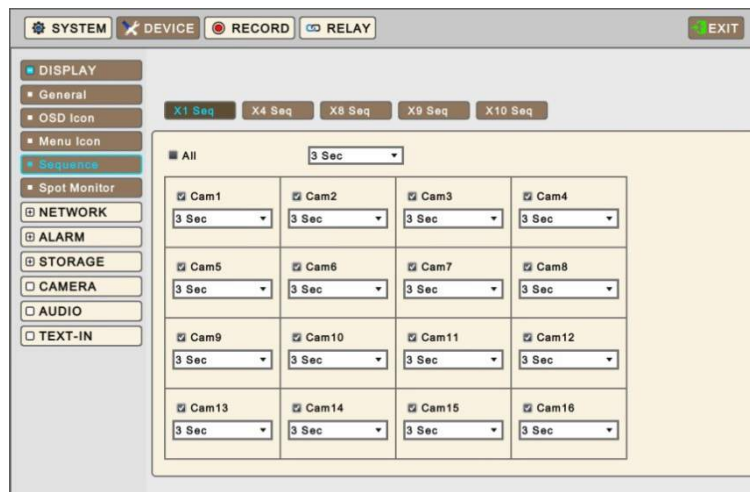

- The Sequence menu allows a user to adjust channel sequencing interval of Main monitor.
 - X1 Seq: Adjust interval for 'Full screen sequencing'.
 - X4 Seq: Adjust interval for '4 split screen sequencing'.
 - X8 Seq: Adjust interval for '8 split screen sequencing'.
 - X9 Seq: Adjust interval for '9 split screen sequencing'.
 - X10 Seq: Adjust interval for '10 split screen sequencing'.
- Check check box next to the camera that wish to include in sequencing. Any camera with unchecked check box will be excluded from channel sequencing.

- To adjust the location of the cameras for each sequence, Click (↔) each Drop-down list and able to select the channel.
- To adjust the rotation interval of cameras, Click (↔) each Drop-down list and select from **3, 5, 10, 15, 30 and 60 seconds**.
If Click (↔) at the top Drop-down list in X1 Seq, Users can adjust all items of interval at once.



- To activate Sequence mode during live monitoring, click  to select the multi-channel split display mode on Display Menu Bar on the left margin of the main monitor.

NOTE

X8, X9, X10 Seq use only with 8/16 channel DVRs and x10 seq use only with 16 channel DVRs

Spot Monitor

- Spot or Multi Spot is only available in **S, A, B, C, D, G (4CH) and J Type**.
- This connection supports multi-channel display (1/4/8/9/10/16) on spot monitor depending on its channels (4/8/16).
- Please Click (↔) **DEVICE>Display>Spot Monitor** and the following screen will display.

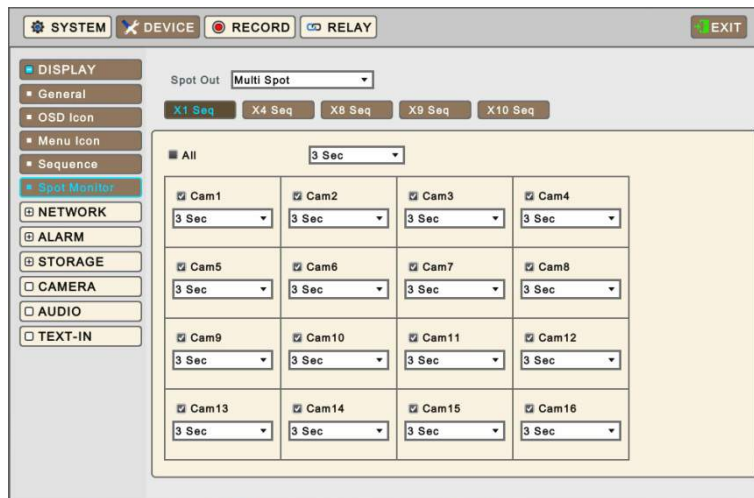

- To Select the type of spot out, Click (↔) combo box (Users can select Multi spot or Spot).
- The Sequence menu allows a user to adjust channel sequencing interval of Spot Monitor.
 - X1 Seq: Adjust interval for 'Full screen sequencing'.
 - X4 Seq: Adjust interval for '4 split screen sequencing'.
 - X8 Seq: Adjust interval for 'Quad screen sequencing'.
 - X9 Seq: Adjust interval for '9 split screen sequencing'.
 - X10 Seq: Adjust interval for '10 split screen sequencing'.
- Check check box next to the camera that wish to include in sequencing. Any camera with unchecked check box will be excluded from channel sequencing.
- To adjust the location of the cameras during the sequence, Click (↔) each Drop-down list and able to select the channel.
- To adjust the rotation interval of cameras, Click (↔) each Drop-down list (Users can select **3, 5, 10, 15, 30 and 60 seconds**).
If Click (↔) at the top Drop-down list in X1 Seq, Users can adjust all items of interval at once.

NOTE

X8, X9, X10 seq use only with 8/16 channel DVRs and x10 seq use only with 16 channel DVRs

4.3.2 Network

- Please Click (←) **DEVICES>Network** and the following screen will show.

LAN

LAN

- Please Click (←) Network Type. When you click the Drop-down list, users can select to Static (fixed IP) or DHCP (floating IP).
- In Static, a user must manually set the static IP address for use.
 - Set IP Address, Subnet Mask, Gateway DNS Server 1 & 2. Please ask your network administrator for more details.
 - To input address, please Click (←) Numpad icon on the right-hand side of each box.
- In DHCP, IP Address, Subnet Mask, Gateway and DNS Server will be assigned automatically from a Router.
- Register UPnP: Click (←) 'On' for automatic port forwarding and Click (←) 'Off' on radio box to do manual port forwarding.
- Bandwidth is to setup an average transfer speed.
- There are total of 14 different networks Bandwidth users may choose. (bps: bit per second) 26 kbps, 128 kbps, 256 kbps, 512 kbps, 1 Mbps, 2 Mbps, 4 Mbps, 8 Mbps, 10 Mbps, 20 Mbps, 40 Mbps, 80 Mbps, 100 Mbps and unlimited(default).
 - Ethernet support Max. 1000Mbps.

CAUTION

THE CONNECTED LOCAL ROUTER SHOULD SUPPORT AND ACTIVATE **UPnP** FEATURE ACCORDINGLY.

SMTP

- If users want to use "dvrdomain.com" which is offered by manufacturer instead of own SMTP server, please click on the check box (dvrdomain.com).
- To use own SMTP, Click (←) the check box on the left-hand side of Own SMTP box
- Click (←) the keyboard icon on the right-hand side of SMTP Server box and the virtual keyboard will display. Please register the SMTP Server. SMTP server can be set up by the users to have own SMTP server on their site.
- Click (←) the keyboard icon on the right-hand side of Sender ID box, Password and Email Sender then the virtual keyboard will display. Please register an ID to the sender mail server (e.g., ryu99).
- Default number of SMTP port is 25. Please note that any Internet Service Provider may have restrictions on the default port. If so, port number 2525 and 587 can be used alternatively.

CAUTION

DUE TO THE VARIOUS LOCAL JUNK MAIL POLICIES, EMAILING MAY NOT WORK PROPERLY. SSL EMAIL SERVERS MAY ALSO NOT WORK CORRECTLY. IF SO PLEASE DEACTIVATE THE SSL FEATURE IN THE (YOUR) SERVER SETUP. NOTE THAT SOME SERVER CANNOT DEACTIVATE THIS FEATURE

Port

- The Port Number Setup menu allows a user to configure Command, Stream and web port, when connecting to network users.
- Port number
 - **Command:** 5000~65535 (Default: 5920)
 - **Stream:** 5000~65535 (Default: 5921)
 - **Web:** 1~65535 (Default: 80)

CAUTION

IT IS NOT POSSIBLE TO CHANGE PORT NUMBER, WHEN A USER IS CONNECTED TO THE DVR VIA NETWORK.
ONCE PORT NUMBERS ARE CHANGED, IT MUST BE ALSO CHANGED THE PORT NUMBERS ON REMOTE SOFTWARE SUCH AS CMS Pro, mViewer Pro, iCMS and xCMS.

Dual Streaming

- To change Frame rate and qualities of dual streaming for Live monitoring, uncheck from the checkbox next to Default Value.
 - Frames : 1, 3, 5, 7, 15 frames for NTSC (1, 3, 5, 6, 12.5 frames for PAL)
 - Qualities : Low, Standard, High, Super

NOTE

Default Frame rate and Quality are 15 and High.

NOTE

Dual Streaming mode reduces network traffic and then show display more smooth at the low speed network environment.

DDNS

- Please Click (←) **DDNS** and the following screen will display.

- DDNS (Dynamic Domain Name System) service registers its unique Domain name to a provided server and allows a user to use the same address name to access the DVR. A user may use 3rd Party DDNS service if they have an account instead of dvrdomain.com.

Dvrdomain.com

- Check a checkbox of Dvrdomain.com to use dvrdomain.com.
- As for DDNS Server, Dvrdomain.com will be showing as default.
- Port number 95 will be shown as default. (It's possible to use 80 alternatively)

- By pressing the 'Get Domain Name', the DVR activates DDNS services and brings a registered DDNS name. A user may use this name as an IP address when they add a DVR on software.

NOTE

DDNS service port number 95 is NOT required to be port forwarded at all.

CAUTION

WHEN A USER'S CONNECTIONG DEVICES (PC, Mac, SMART PHONES, etc.) ARE UNDER THE SAME ROUTHER WITH A DVR, THE USER CANNOT USE THE DDNS NAME TO CONNECT. USE THE DVR'S PRIVATE IP ADDRESS FOR THIS CASE.

3rd Party DDNS

- Check a checkbox of 3rd Party to use dyndns.org or no-ip.com Server.
- As for DDNS Server, dyndns.org will be showing as default. To change server, Click (↔) Drop-down list of DDNS Server.

- As for Domain Name, users have to input the Domain Name given from the selected DDNS Server.
- As for ID and Password, use the user ID and Password to log in to the selected DDNS Server.
- Click "Run DDNS service" to start mapping from DVR to DDNS Server.

NOTE

Users must join 'dyndns.org' or 'no-ip.com' prior to using it as DDNS server. Please check corresponding website for more information.

NOTE

If system doesn't get domain name, please check network status.

NOTE

For the security reason, please change the admin's password other than the default

4.3.3 Alarm

Please Click (↔) **DEVICES>Alarm** and the following screen will display.

No.	Use	Name	Type
All	<input checked="" type="checkbox"/>	All	NC
1	<input checked="" type="checkbox"/>	AI 1	NC
2	<input checked="" type="checkbox"/>	AI 2	NC
3	<input checked="" type="checkbox"/>	AI 3	NC
4	<input checked="" type="checkbox"/>	AI 4	NC
5	<input checked="" type="checkbox"/>	AI 5	NC
6	<input checked="" type="checkbox"/>	AI 6	NC
7	<input checked="" type="checkbox"/>	AI 7	NC
8	<input checked="" type="checkbox"/>	AI 8	NC
9	<input checked="" type="checkbox"/>	AI 9	NC
10	<input checked="" type="checkbox"/>	AI 10	NC
11	<input checked="" type="checkbox"/>	AI 11	NC
12	<input checked="" type="checkbox"/>	AI 12	NC
13	<input checked="" type="checkbox"/>	AI 13	NC
14	<input checked="" type="checkbox"/>	AI 14	NC
15	<input checked="" type="checkbox"/>	AI 15	NC
16	<input checked="" type="checkbox"/>	AI 16	NC

Alarm In

- The Alarm In menu will allow users to give title and to select the type of Alarm input.
- Click (⌨) the keyboard icon on the right-hand side of each box on name column or name column and the virtual keyboard will display. Then, please register the title of Alarm input.
- When a check box is marked on Use, a corresponding Alarm starts operating. However, if a user does not check the check box, the operation stops. If Click (⌨) 'All' of use box, all items are check/uncheck at once.
- Click (⌨) each box on Type column to select type of a corresponding Alarm input. If Click (⌨) 'NC/NO' of Type column, all items can be changed NC/NO at once.
 - **NO**: contact is normally open
 - **NC**: contact is normally closed

Alarm Out

- Please Click (⌨) **Alarm Out** and the following screen will display.

No.	Use	Name	Type	Duration
All	<input checked="" type="checkbox"/>	All	NO	5 Sec
1	<input checked="" type="checkbox"/>	AO 1	NO	5 Sec
2	<input checked="" type="checkbox"/>	AO 2	NO	5 Sec
3	<input checked="" type="checkbox"/>	AO 3	NO	5 Sec
4	<input checked="" type="checkbox"/>	AO 4	NO	5 Sec
5	<input checked="" type="checkbox"/>	AO 5	NO	5 Sec
6	<input checked="" type="checkbox"/>	AO 6	NO	5 Sec
7	<input checked="" type="checkbox"/>	AO 7	NO	5 Sec
8	<input checked="" type="checkbox"/>	AO 8	NO	5 Sec
9	<input checked="" type="checkbox"/>	AO 9	NO	5 Sec
10	<input checked="" type="checkbox"/>	AO 10	NO	5 Sec
11	<input checked="" type="checkbox"/>	AO 11	NO	5 Sec
12	<input checked="" type="checkbox"/>	AO 12	NO	5 Sec
13	<input checked="" type="checkbox"/>	AO 13	NO	5 Sec
14	<input checked="" type="checkbox"/>	AO 14	NO	5 Sec
15	<input checked="" type="checkbox"/>	AO 15	NO	5 Sec
16	<input checked="" type="checkbox"/>	AO 16	NO	5 Sec
1	<input checked="" type="checkbox"/>	RO 1	NO	5 Sec
2	<input checked="" type="checkbox"/>	RO 2	NO	5 Sec

- The Alarm Out menu will allow a user to give title and to select the type of Alarm output.
- Click (⌨) the keyboard icon on the right-hand side of each box on name column or name column and the virtual keyboard will display. Then, please register the title of Alarm output.
- When a check box is marked on Use, a corresponding Alarm output starts operating. However, if a user does not check the check box, the operation stops. If Click (⌨) 'All' of use box, all items are check/uncheck at once.
- Click (⌨) each box on Type column to select type of a corresponding Alarm output. If Click (⌨) 'NC/NO' of Type column, all items can be changed NC/NO at once.
 - **NO**: contact is normally open
 - **NC**: contact is normally closed
- Users may change duration of all Alarm output.

4.3.4 Storage

- Please Click (⌨) **DEVICE>STORAGE** and the following screen will display.

No.	Information	Capacity	Used	Temp.	S.M.A.R.T	Format	Status
1	[P3] WDC ...	976 GB	38 GB	37 °C	OK	Yes	Writing

HDD Format

- This page shows information of HDDs installed in the DVR.
- When users install full storage device and DVD-RW including one e-SATA storage(**C, F, G H, I and J Type**), then following procedures will be listed as below:
 - 1. Internal SATA 1~4 Ports
 - 2. External SATA 1~4 Ports
 - 3. DVD-RW
- Under “Information”, it is possible to find the port number where each HDD is connected.
 - For Internal SATA, [P1], [P2], [P3] and [P4] each represents internal Port 1, Port 2, Port 3 and Port 4.
 - For External SATA, [E1], [E2], [E3] and [E4] each represents external Port 1, Port 2, Port 3 and Port 4.
- Users must format when:
 - install new HDD
 - add another HDD
 - replace HDD
 - move HDD (change installation port)
 - remove HDD
- Use to delete or purge all normal recorded data from database. Please follow the procedure below.
 - ① Click (←) Clear All Data box.
 - ② When a Message box asking “All the data will be deleted and cannot be restored. Proceed?” shows, choose ‘OK’ to confirm.
 - ③ Then, Progress window will display and the process starts.
 - ④ When all data are deleted, a message box “HDD format has been completed.” will pop up.

NOTE

When users add used HDDs from the same type of DVR, users can access data in DVRs as Read-Only or keep

CAUTION

DELETED DATA CANNOT BE RESTORED.

S.M.A.R.T

- Please Click (←) **S.M.A.R.T** and the following screen will display.

HDD Info.	ID	Name	Value	Worst	Threshold	Raw	Status
WD-WCAV9K825408	1	Raw_Read_Error_Rate	200	200	51	0	OK
WD-WCAV9K825408	3	Spin_Up_Time	124	119	21	6775	OK
WD-WCAV9K825408	4	Start_Stop_Count	100	100	0	297	OK
WD-WCAV9K825408	5	Reallocated_Sector_Ct	200	200	140	0	OK
WD-WCAV9K825408	7	Seek_Error_Rate	100	253	0	0	OK
WD-WCAV9K825408	9	Power_On_Hours	86	86	0	10756	OK
WD-WCAV9K825408	10	Spin_Retry_Count	100	100	0	0	OK

S.M.A.R.T

- S.M.A.R.T shows the status of HDD connected to the DVR.
- Click (←) Refresh box to refresh status of HDDs as the S.M.A.R.T setup.

Notification

- A user can set Notification when BAD are detected by S.M.A.R.T.
- Check Alarm out: users can set the alarm out, when “Bad” detects from HDDs. If Click (←) ‘All’, all items are check/uncheck at once.
- Check Email: users can receive the email notification to registered email address, when Bad detects from HDDs. If Click (←) ‘All’, all items are check/uncheck at once.

- Check Beep: When Bad detects from HDDs, it will give the alarm sound.
- Check Message: When Bad detects from HDDs, the alarm message will pop up on the OSD.

NOTE



When “Attention or Warning” is detected by S.M.A.R.T, notification (Alarm out, Email, Beep and Message) will not activate.

Overwrite

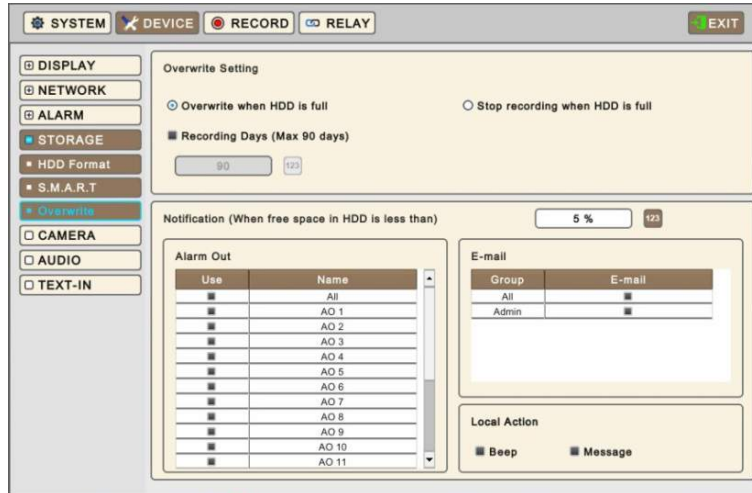
- Click (↔) Overwrite and the following screen will display.



Overwrite Setting

- Click (↔) Overwrite box and users may activate the overwrite function. (Overwriting mode is default)
 - This function makes restart the recording from the beginning when the HDD is full. The previous recorded data will be erased from the first one. Following icon will display in bottom of live mode. 
- A user shall designate the total recording days from 1 day to 90 days and unlimited.
- Click (↔) Stop recording box and users may deactivate the overwrite function.
 - Recording will stop automatically when the HDD is full.
 - At no Overwrite mode,  will display while the recording is going on.

Notification

- Users may set the certain value of HDD usage for notification. It will notify, when free space in HDD is less than the specified value. The values are from 0 ~ 100%
- Check Alarm out: users can set the alarm out, when free space in HDD is less than the specified value. If Click (↔) ‘All’, all items are check/uncheck at once.
- Check E-mail: users can receive the email notification to registered email address, when free space in HDD is less than the specified value. If Click (↔) ‘All’, all items are check/uncheck at once.
- Check Beep: a DVR makes beeping sound when free space in HDD is less than the specified value.
- Check Message: the warning message “Free space in HDD is less than (xx%)!” will display on the OSD

CAUTION

IF USERS USE “Recording Days” FUNCTION, DVR WILL STORE ONLY THE DAYS THAT SPECIFIED BY USERS AND STOPS RECORDING. PLEASE BEWARE OF DATA LOSS DUE TO “Rec Days” FUNCTION.

NOTE

Notify setting does not affect saving the recorded data. It only gives notification and keep recording until hard disk is full.

NOTE

For more specific setting about Alarm-out, use **Setup>DEVICE>ALARM>Alarm Out**.

4.3.5 Camera

- Please Click (←) **DEVICE>CAMERA** and the following screen will display.

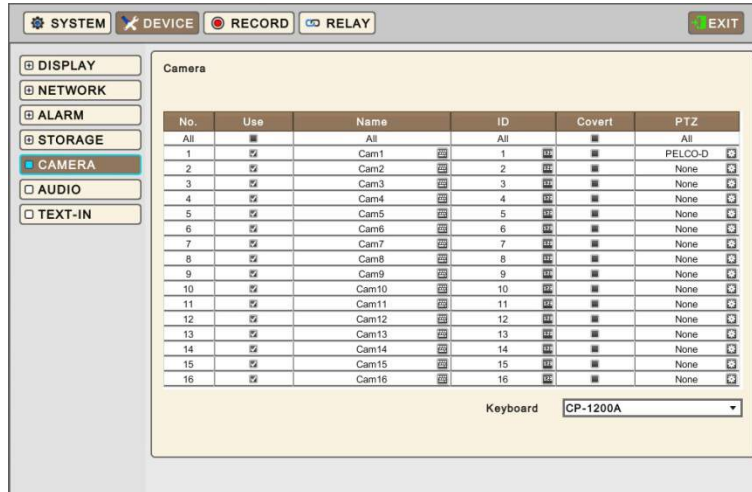

- Click (←) the each Name box and the virtual keyboard will display. Then, register names of cameras.
- If a check box is checked on Use column, a video of the corresponding camera is recorded and displayed on the monitor. However, if a user does not check the checkbox, "UNUSE" text will be displayed on the channel. If Click (←) 'All', all items are check/uncheck at once.
- Click (←) the each ID box and the virtual Numpad will display. Then, set ID Number of Cameras (i.e., 0 ~ 9999). The assigned ID will be used for RS485/RS422/PTZ operations if applicable.
- If a check box is checked on Covert box, a video is recorded but is not displayed on the monitor. If Click (←) 'All', all items are check/uncheck at once.
- Click (←) each PTZ Column to set PTZ Settings connected to a corresponding camera. And the following screen will display.

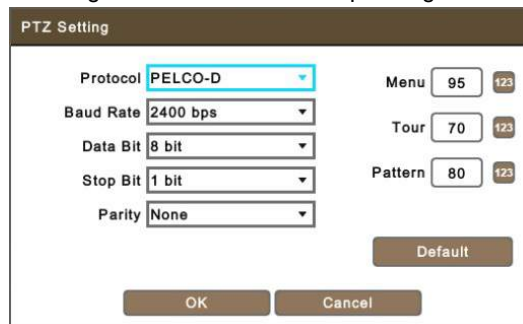

- Click (←) Drop-down list of Protocol / Baud Rate / Data Bit / Stop Bit / Parity to set PTZ settings of the Camera
- Menu, Tour and Pattern help users to use OSD function of PTZ camera.
 - If a PTZ camera itself supports OSD menu, use the setup values to enter and use the OSD menu using the DVR interface.
 - If OSD entering command is 95 + PSET for example, designate 95 for Menu item,
 - If shortcut key to use Tour function is 71 ~ 79 + PSET, designate 70 for Tour item and
 - If shortcut key to use Pattern function is 81 ~ 89 + PSET, designate 80 for Pattern item.
 - The setting information herein is used for **PAN / TILT control** in 5.1.5 (to be described).
 - For further details on settings, please refer to the PTZ camera manual. Every PTZ camera manufacturer may have a different setting on above. Please contact PTZ camera manufacturer for special preset reservation.
- If users Click (←) **Default**, PTZ setting restores its default.
- Please choose 'OK' to confirm settings and choose 'Cancel' to cancel.
- Click (←) Drop-down list of keyboard to select keyboard. This is used when a user uses Keyboard Joystick for DVR(s) and PTZ Camera(s). You may disregard when you connect PTZ camera(s) to a Keyboard Joystick directly

NOTE

When using RS-485 over Coax for **S, A, B, C, I (Analog) and J Type**, users can select any protocol from the Protocol list other than 'NONE'. If 'NONE' is selected then RS-485 over Coax will not work. The PTZ camera should supports RS-485 over Coax feature to work with.

4.3.6 Audio

• Please Click (←) **DEVICES>Audio** and the following screen will display.

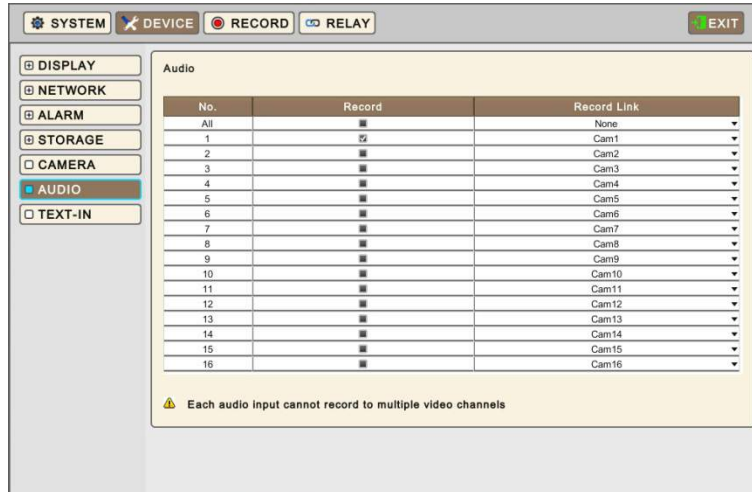

- The Audio menu allows a user to choose whether to record Audio, if connected
- When a check box is marked on Record column, corresponding audio and video from Linked Camera will be recorded. However, if the check box is not marked, audio will not record. And If Click (←) 'All', all items are check/uncheck at once.
- Click (←) Drop-down list of Record Link to select Linked cameras

CAUTION

AN AUDIO INPUT CANNOT BE LINKED TO 2 OR MORE VIDEO CHANNELS.

4.3.7 Text-In

NOTE

Please refer to "12. TEXT-IN".

4.4 RECORD

4.4.1 Record

- A DVR has 5 different types of recording mode as followings. A user may combine those 5 and apply by hour basis.
 - **Continuous:** record continuously.
 - **Motion:** record only when motion is detected.
 - **Alarm:** record only when Alarm In is detected.
 - **Emergency:** record when a user presses **Emergency** key. (Front panel, Remote controller, Mouse selection)
 - **Pre-Event:** record before Motion, Alarm and Emergency event triggered.

• Below lists show the maximum recording rate of a DVR by recording resolution.

-960H Type- (Maximum Recording Rate by Resolution)

S (4, 8CH), A, B, C and D Type

NTSC (PAL)	360x240 (360x288)	720x240 (720x288)	720x480 (720x576)	960x480 (960x576)
4 Channel DVR	120 (100)	120 (100)	120 (100)	120 (100)
8 Channel DVR	240 (200)	240 (200)	240 (200)	240 (200)
16 Channel DVR	480 (400)	480 (400)	480 (400)	480 (400)

-HD-SDI Type- (Maximum Recording Rate by Resolution)

E and F Type

30/60hz (25/50hz)	960x480 (960x576)	1280 x 720	1920 x 1080
4 Channel DVR	30 (25) fps per Channel	30 (25) fps per Channel	30 (25) fps per Channel
8 Channel DVR	30 fps per Channel	30 fps per Channel	15 fps per Channel
16 Channel DVR	30 fps per Channel	30 fps per Channel	15 fps per Channel

G Type

30/60hz (25/50hz)	960x480 (960x576)	1280 x 720	1920 x 1080
4 / 8 / 16 Channel DVR	30 (25) fps per Channel	30 (25) fps per Channel	30 (25) fps per Channel

H Type

30/60hz (25/50hz)	960x480 (960x576)	1280 x 720	1920 x 1080
4 / 8 Channel DVR	60 (50) fps per Channel	60 (50) fps per Channel	60 (50) fps per Channel

I Type

•HD-SDI Input (CH 1 ~ 4)

30/60hz (25/50hz)	960x480 (960x576)	1280 x 720	1920 x 1080
4 Channel	30(25) fps per Channel	30(25) fps per Channel	30(25) fps per Channel

• Analog Input (CH 5 ~ 16)

NTSC (PAL)	360x240 (360x288)	720x240 (720x288)	720x480 (720x576)	960x480 (960x576)
12 Channel	360 (300)	360 (300)	360 (300)	360 (300)

J Type (True Hybrid - All Channel Hybrid)

•HD-SDI & Analog Input (CH 1 ~ 16)

30/60hz (25/50hz) & NTSC (PAL)	960x480 (960x576)	1280 x 720	1920 x 1080
8 / 16 Channel	30(25) fps per Channel	30(25) fps per Channel	30(25) fps per Channel

NOTE

The actual displayed frame could be different by camera signal frequency (Hz, HD-SDI) and/or local standard (PAL/NTSC, Analog)

Except E (8/16), F (8/16) Type.

- HD-SDI: 1, 3, 5, 7, 15, 25, 50 (25 Hz & 50 Hz) / 1, 3, 5, 7, 15, 30, 60 (30 Hz & 60 Hz)
- Analog: 1, 3, 5, 6, 12.5, 25, 50 (PAL) / 1, 3, 5, 7, 15, 30, 60 (NTSC)

NOTE

E, F, G, H, I and J Type DVRs can detect 1080i, 1080p or 720p HD-SDI signals. If a user connects cameras before the booting, each signal is automatically detected and recognized (Auto Detection).

NOTE

Please reboot the DVR, when switch from HD-SDI to Analog or Analog to HD-SDI (**J Type only**)

CAUTION

IF A USER CONNECTS DIFFERENT TYPES OF HD-SDI SIGNALS WHILE DVR IS OPERATING, IT MAY CAUSE MALFUNCTIONS OF DVR.

Continuous

- Please Click (↔) **Continuous** and the following screen will display.

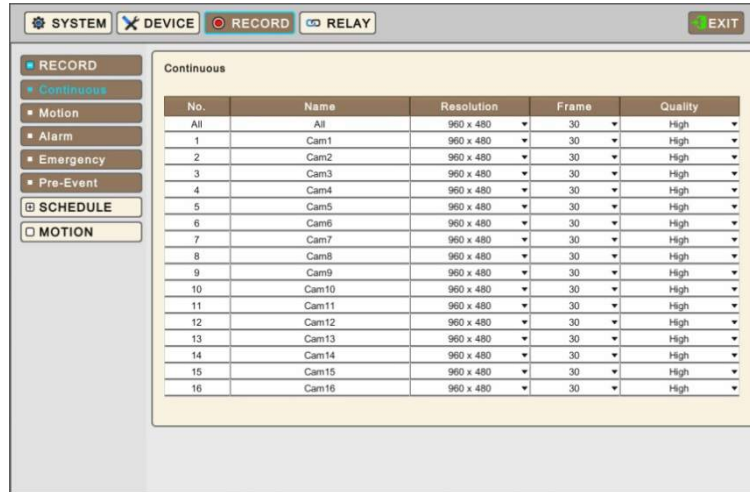

- The Continuous menu allows a user to set occasional recording rates and resolution.
- Each box on Title column shows camera title registered in **DEVICES>Camera**. A user cannot change camera titles here.
- Click (↔) each box on Resolution column to select recording resolution of a corresponding camera. A user may select one of **360x240(288), 720x240(288), 720x480(576), 960x480(576), 1280x720 and 1920x1080**.
- Click (↔) each box on Frames column to select recording rate of a corresponding camera. Recording rate varies by selected recording resolution.
- Click (↔) each box on 'Quality' column to select recording quality of a corresponding camera. A user may select its recording quality from **Super, High, Standard and Low**.
- Click (↔) Drop-down list to change the setting values of Resolution, Frames, Quality. And If Click (↔) Drop-down list of all box, All items are changed at once

Motion

- Please Click (↔) **Motion** and the following screen will display.

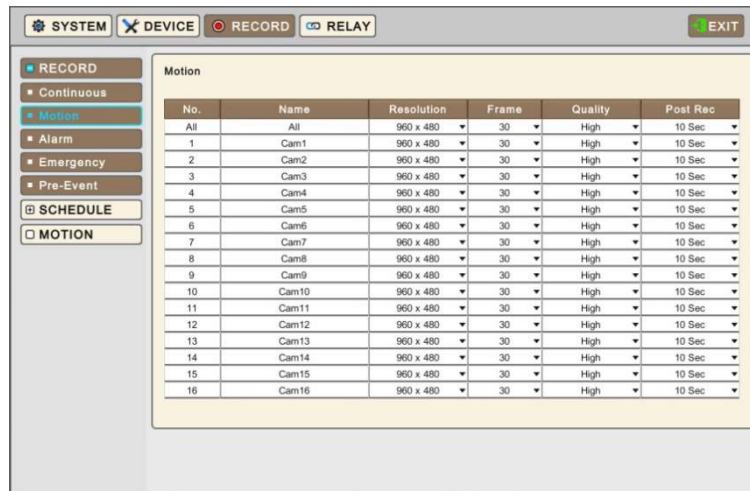

- The Motion menu allows a user to set Motion based recording rates and resolution.
- Each box on Title column shows camera title registered in **DEVICES>Camera**. A user cannot change camera titles here.
- Click (↔) each box on Resolution column to select recording resolution of a corresponding camera. A user may select one of **360x240(288), 720x240(288), 720x480(576), 960x480(576), 1280x720 and 1920x1080**.
- Click (↔) each box on Frames column to select recording rate of a corresponding camera. Recording rate varies by selected recording resolution.
- Click (↔) each box on 'Quality' column to select recording quality of a corresponding camera. A user may select its recording quality from **Super, High, Standard and Low**.
- Click (↔) each box on 'Post Rec' column to select recording duration (**10 seconds ~ 10 minutes**) of a corresponding camera.
- Click (↔) Drop-down list to change the setting values of Resolution, Frames, Quality and Post Rec. And If Click (↔) Drop-down list of all frame, All items are changed at once

Alarm

- Please Click (←) **Alarm** and the following screen will display.

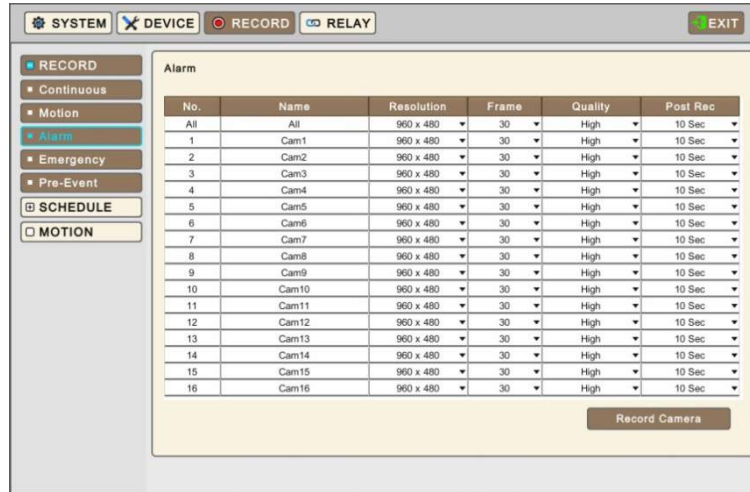

- The Alarm menu allows a user to set Alarm based recording rates and resolution.
- Each box on Title column shows camera title registered in **DEVICES>Camera**. A user cannot change camera titles here.
- Click (←) each box on Resolution column to select recording resolution of a corresponding camera. A user may select one of **360x240(288), 720x240(288), 720x480(576), 960x480(576), 1280x720 and 1920x1080**.
- Click (←) each box on Frames column to select recording rate of a corresponding camera. Recording rate varies by selected recording resolution.
- Click (←) each box on 'Quality' column to select recording quality of a corresponding camera. A user may select its recording quality from **Super, High, Standard and Low**.
- Click (←) each box on 'Post Rec' column to select recording duration (**10 seconds ~ 10 minutes**) of a corresponding camera.
- Click (←) Drop-down list to change the setting values of Resolution, Frames, Quality and Post Rec. And If Click (←) Drop-down list of all frame, All items are changed at once

NOTE

E, F, G, H, I and J Type DVRs can detect 1080i, 1080p or 720p HD-SDI signals. If a user connects cameras before the booting, each signal is automatically detected and recognized (Auto Detection).

CAUTION

IF A USER CONNECTS DIFFERENT TYPES OF HD-SDI SIGNALS WHILE DVR IS OPERATING. IT MAY CAUSE MALFUNCTIONS OF DVR.

Record Camera

- Click (←) **Record Camera** to change the setting of Alarm in Record Camera and the following screen will display.



- A user can manually choose which cameras to record when Alarm In occurs.
- Please choose 'OK' to confirm the setting and choose 'Cancel' to cancel.

Emergency

- Please Click (↔) **Emergency** and the following screen will display.

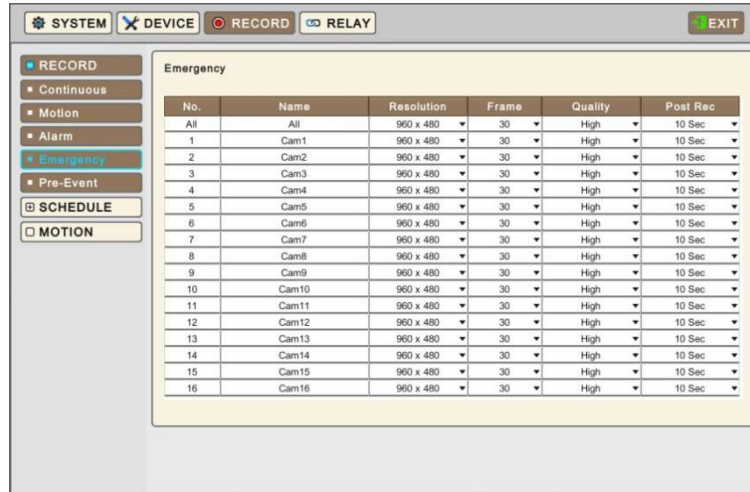

- The Emergency menu allows a user to set Emergency based recording rates and resolution, when 'Emergency button pressed.
- Each box on Title column shows camera title registered in **DEVICES>Camera**. A user may not change camera titles here.
- Click (↔) each box on Resolution column to select recording resolution of a corresponding camera. A user may select one of **360x240(288), 720x240(288), 720x480(576), 960x480(576), 1280x720 and 1920x1080**.
- Click (↔) each box on Frames column to select recording rate of a corresponding camera. Recording rate varies by selected recording resolution.

Pre-Event

- Please (↔) **Pre-Event** and the following will display.



- Pre-Event is effectively used when a user selects recording mode by Motion, Alarm or Emergency.
- Pre-Event feature allows a user to make a DVR to record at the same conditions as defined at Motion, Alarm, and Emergency for a period of 'up to' actual event triggered time.
- Please follow the setup procedures below.
 - ① Click (↔) Drop-down list of Duration box to select recording duration (**10 second ~ 10 minutes**)
 - ② Click (↔) Drop-down list of "Record follows" to apply the same Recording Setting of Motion, Alarm or Emergency for a period as defined above.

NOTE

Pre-Event recording conditions are dependent on Motion, Alarm or Emergency which is configured by the user.

4.4.2 Schedule

- Please Click (←) **RECORD>Schedule** and the following will display.

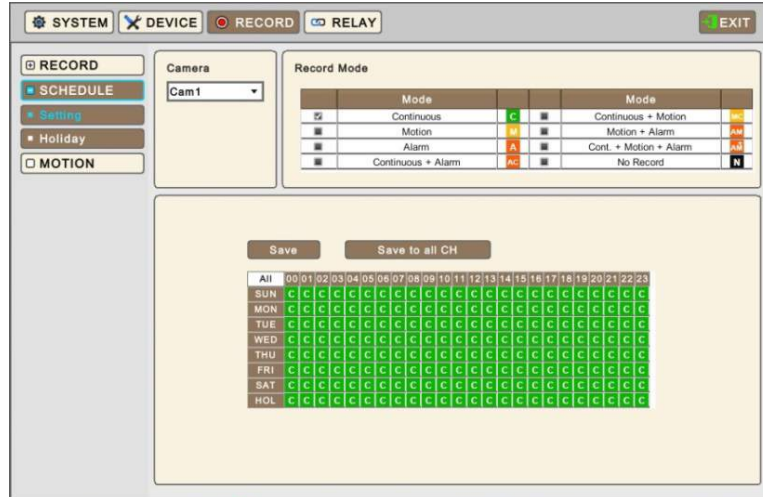

Setting

- The Schedule table displays one week divided by hour and date. Each cell represents one hour. A user may choose appropriate recording conditions by hour. Holidays could be defined by a user separately.
- Click (←) Drop-down list of Camera box to select Camera.
- Please set the recording mode as follows:
 - ① Mark a check box to select record mode in record mode table.
 - ② Click block, row, column to register desired recording mode.
 - Click (←) a cell and only the cell will be registered.
 - Click (←) a row (SUN~HOL) and the entire row will be registered.
 - Click (←) a column (00~23) and the entire column will be registered.
 - ③ Click (←) Save button to save setting
- Click and hold mouse cursor on the Schedule table and then brush as you want. The brushed cells will be registered as your record mode selection.
- Repeat the procedure for Camera No. 2 to 16. If a user wants all other cameras to have the same mode, please Click (←) Save to all CH button.

Holiday

- Please Click (←) Schedule>Holiday and the following screen will display.

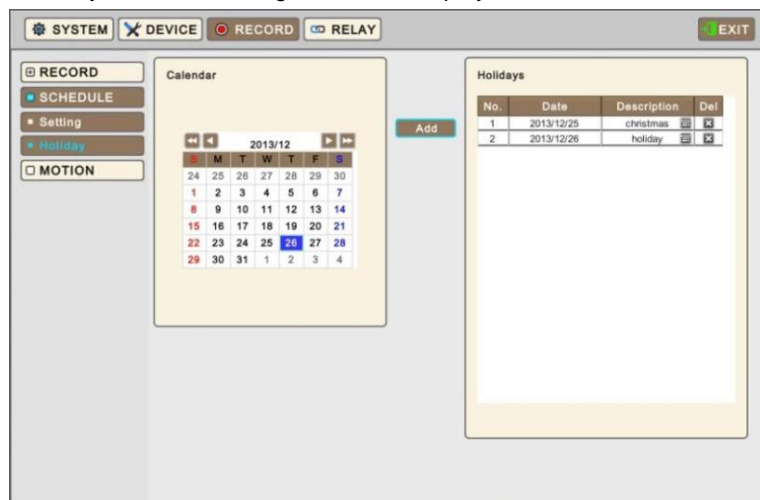

- The Holiday menu allows a user to register holidays. Please follow the registration procedure below.
 - ① Use arrow buttons in the Month Calendar to select Year and Month of holiday to be registered.
 - ►►: Move to next 'Year'
 - ◀◀: Move to previous 'Year'
 - ►: Move to next 'Month'
 - ◀: Move to previous 'Month'

- ② Click (↔) on date needed to be registered as holiday.
 - ③ Click (↔) ADD button and Virtual keyboard will display to input description of holiday
 - ④ Please choose 'OK' to confirm the input and the date will be copied to the Holidays table.
 - ⑤ If wish to delete the registration of a certain holiday, please Click ☒ button next to the Holiday table.
- Since holidays may vary every year, we recommend user to update on a regular basis.

4.4.3 Motion

- Please Click (↔) **RECORD>Motion** and the following screen will display.

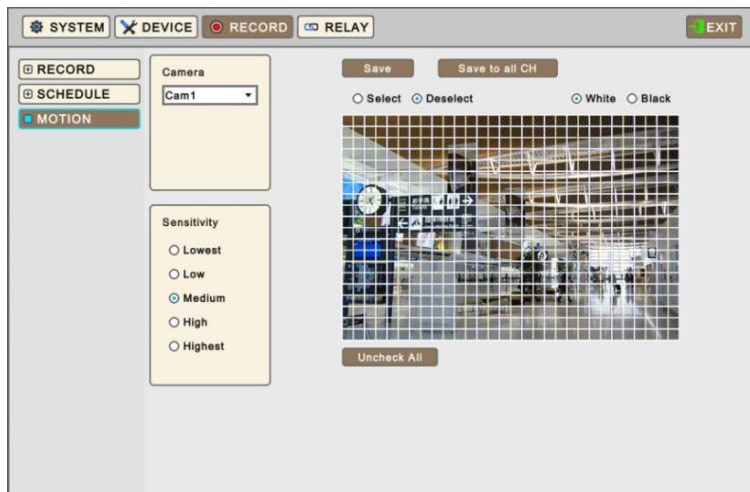

- Click (↔) Drop-down list of Camera box to select Camera.
- Please set the motion detection area as follows:
 - ① Select Sensitivity in Sensitivity box (Lowest, Low, Medium, High and Highest)
 - ② Click (↔) **Uncheck All** to Deselect the area first.
 - ③ Click (↔) 'Select' and will be able to select the area of detection on the grid.
 - ④ Click blocks to activate.
 - ⑤ Click (↔) Save button to save setting
- Drag and Drop Mouse Cursor on Blocks and rows/columns to select/unselect the areas.
- Repeat the procedure for Camera No. 2 to 16. If a user wants every camera to have the same mode, please Click (↔) "Save to all CH" button.
- Click (↔) White or Black to change color of line on the grid.

4.5 RELAY

- Please Click (↔) **RELAY** and the following screen will display.

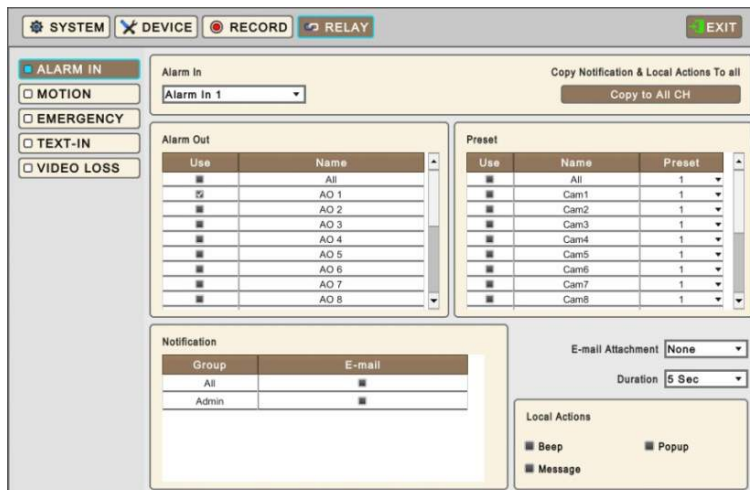

- The Relay menu allows a user to setup action plans when events (Alarm In, Motion, Emergency, Text-In, and Video Loss) happen. A user may activate Alarm Out, PTZ Preset, Email Notification, Beeping, OSD popup and Message by those.

4.5.1 ALARM IN

- Select Alarm out, Preset and Notification to use when Alarm In sensor goes off.
- Link Notification displays E-mail addresses registered in **System>General>Account>User>Email**
- Please follow the setup procedures below.
 - ① Click (↔) Drop-down list of Alarm In box and select Alarm In.
 - ② Select Alarm out to be worked when selected Alarm In is on. Please check a check box of use column on Alarm Out box. More than one alarm outputs can be set. If Click (↔) 'All' of use box, all items are checked/unchecked at once.
 - ③ Select cameras for preset when Alarm In is on. Please check a check box of use column on Preset box. More than two cameras can be set. If Click (↔) 'All' of use box, all items are checked/unchecked at once
 - ④ Click (↔) Drop-down list of Preset to change Cameras preset. If Click (↔) Drop-down list of all preset box, all items are changed at once
 - ⑤ Select group for notification when Alarm In is on. Please check a check box of E-Mail box. More than two Groups can be set.
 - ⑥ Click (↔) Drop-down list of E-mail Attachment box to attach None, JPGE or EXE
 - ⑦ Click (↔) Drop-down list of Duration column to set the duration of recorded data for attached EXE
 - ⑧ Select Local Actions
 - Beep: When Alarm In is on, it will give the alarm sound
 - Popup: When Alarm In is on, it will make the popup screen on the main monitor
 - Message: When Alarm In is on, the alarm message will pop up on the OSD
 - ⑨ Repeat the above procedure for Alarm In 2~ Alarm In 16 (Up to 2 for **A and E(4CH) Type** / Up to 4 for **B and E(8, 16CH) Type** / Up to 8 for **I Type** / Up to 16 for **C, D, F, G, H and J Type**).
- Click (↔) Copy to All CH button to copy Notification & Local Actions to all channels.
- To select cameras for recording when alarm In is on, Please change setting in **Record>Recording>Alarm>Record camera**

4.5.2 MOTION

- Please Click (↔) **RELAY>MOTION** and the following screen will display.

The screenshot shows the MOTION configuration screen with the following details:

- Camera:** Cam 1
- Copy Notification & Local Actions To all:** Copy to All CH
- Alarm Out Table:**

Use	Name
<input checked="" type="checkbox"/>	All
<input type="checkbox"/>	AO 1
<input type="checkbox"/>	AO 2
<input type="checkbox"/>	AO 3
<input type="checkbox"/>	AO 4
<input type="checkbox"/>	AO 5
<input type="checkbox"/>	AO 6
<input type="checkbox"/>	AO 7
<input type="checkbox"/>	AO 8
- Preset Table:**

Use	Name	Preset
<input checked="" type="checkbox"/>	All	1
<input type="checkbox"/>	Cam1	1
<input type="checkbox"/>	Cam2	1
<input type="checkbox"/>	Cam3	1
<input type="checkbox"/>	Cam4	1
<input type="checkbox"/>	Cam5	1
<input type="checkbox"/>	Cam6	1
<input type="checkbox"/>	Cam7	1
<input type="checkbox"/>	Cam8	1
- Notification Table:**

Group	E-mail
All	<input checked="" type="checkbox"/>
Admin	<input checked="" type="checkbox"/>
- E-mail Attachment:** None
- Duration:** 5 Sec
- Local Actions:**
 - Beep
 - Message
 - Popup

- Select Alarm out, Preset and Notification to use when a motion is detected on cameras.
- Link Notification displays E-mail addresses registered in **System>General>Account>User>Email**
- Please follow the setup procedures below.
 - ① Click (↔) Drop-down list of camera box and select Camera.
 - ② Select alarm outputs to be worked when Motion of selected Camera is detected. Please check a check box of use column on Alarm Out frame. More than two alarm outputs can be set. If Click (↔) 'All' of use box, all items are checked/unchecked at once
 - ③ Please check a check box of use box on Preset frame. More than two cameras can be set. If Click (↔) 'All' of use box, all items are checked/unchecked at once
 - ④ Click (↔) Drop-down list of Preset to change Cameras preset. If Click (↔) Drop-down list of all preset box, all items are changed at once
 - ⑤ Select group for notification when Cam 1 is detected Motion. Please check a check box of E-Mail box. More than two Groups can be set.
 - ⑥ Click (↔) Drop-down list of E-mail Attachment box to attach None, JPEG or EXE

- ⑦ Click (↔) Drop-down list of Duration box to set the duration of recorded data for attached EXE
- ⑧ Select Local Actions
 - Beep: When selected Camera detects Motion, it will give the alarm sound
 - Popup: When selected Camera detects Motion, it will make the popup screen on the main monitor
 - Message: When selected Camera detects Motion, the Motion message will pop up on the OSD
- Repeat the above procedure for Cam 2~ Cam 16
- Click (↔) Copy to All CH button to copy Notification & Local Actions to all channels.

4.5.3 EMERGENCY

- Please Click (↔) **RELAY>EMERGENCY** and the following screen will display.

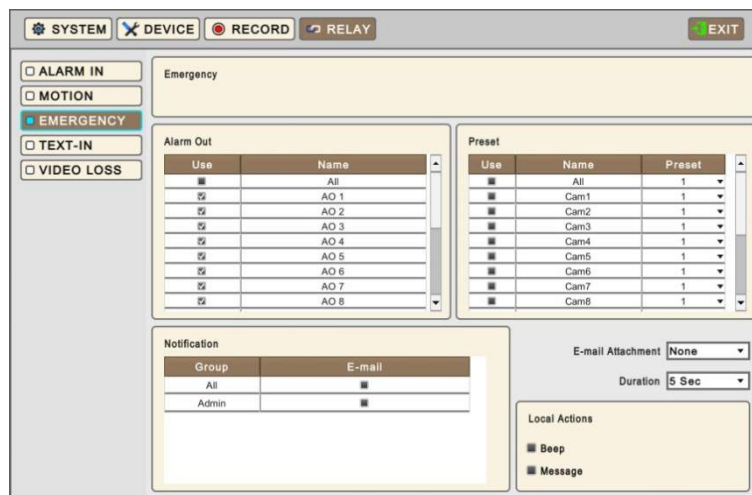

- Select Alarm out, Preset and Notification to use when Emergency button pressed.
- Link Notification displays E-mail addresses registered in **System>General>Account>User>Email**
- Please follow the setup procedures below.
 - ① Select alarm outputs to be worked when Emergency button is pressed. Please check a check box of use column on Alarm Out box. More than two alarm outputs can be set. If Click (↔) 'All' of use box, all items are checked/unchecked at once
 - ② Please check a check box of use column on Preset box. More than two cameras can be set. If Click (↔) 'All' of use box, all items are checked/unchecked at once
 - ③ Click (↔) Drop-down list of Preset to use Cameras preset. If Click (↔) Drop-down list of all preset box, all items are changed at once
 - ④ Select group for notification when video loss is occurred. Please check a check box of E-Mail box. More than two Groups can be set.
 - ⑤ Click (↔) Drop-down list of E-mail Attachment box to attach None, JPEG or EXE.
 - ⑥ Click (↔) Drop-down list of Duration column to set the duration of recorded data for attached EXE
 - ⑦ Select Local Actions
 - Beep: When Emergency is occurred, it will give the alarm sound
 - Message: When Emergency is occurred, the Emergency message will pop up on the OSD

4.5.4 TEXT-IN

• Please Click (↔) **RELAY>TEXT-IN** and the following screen will display.

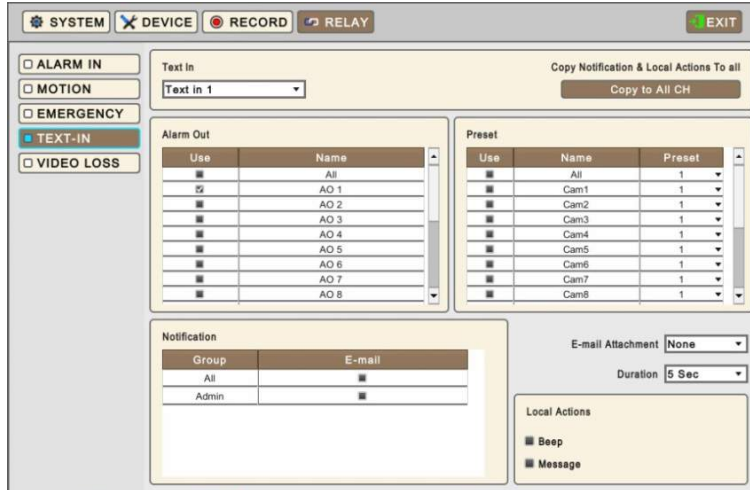

- Select cameras for Preset, Alarm Out and Notification to use when Text In comes to DVR. (PTZ Preset is frequently used for this case).
- Link Notification displays E-mail addresses registered in **System>General>Account>User>Email**
- Please follow the setup procedures below.
 - ① Click (↔) Drop-down list of Text In box and select Text 1.
 - ② Select alarm outputs to be worked when Text In 1 is on. Please check a check box of use column on Alarm Out box. More than two alarm outputs can be set. If Click (↔) 'All' of use box, all items are checked/unchecked at once.
 - ③ Select cameras for preset when Text In 1 is on. Please check a check box of use column on Preset frame. More than two cameras can be set. If Click (↔) 'All' of use column, all items are checked/unchecked at once
 - ④ Click (↔) Drop-down list of Preset to change Cameras preset. If Click (↔) Drop-down list of all preset box, all items are changed at once
 - ⑤ Select group for notification when Text In 1 is on. Please check a check box of E-Mail box. More than two Groups can be set.
 - ⑥ Click (↔) Drop-down list of E-mail Attachment box to attach None, JPEG or EXE.
 - ⑦ Click (↔) Drop-down list of Duration box to set the duration of recorded data for attached EXE.
 - ⑧ Select Local Actions
 - Beep: When Text In 1 is on, it will give the alarm sound
 - Message: When Text In 1 is on, the alarm message will pop up on the OSD
- Repeat the above procedure for Text In 2~ Text In 4
- Click (↔) Copy to All CH button to copy Notification & Local Actions to all channels.

4.5.5 VIDEO LOSS

• Please Click (↔) **RELAY>VIDEO LOSS** and the following screen will display.



- Select Alarm out, Preset and Notification to use when Video Loss occurs on each channel.

- Link Notification displays E-mail addresses registered in **System>General>Account>User>Email**
- Please follow the setup procedures below.
 - ⑨ Click (↔) Drop-down list of camera box and select Cam 1.
 - ⑩ Select alarm outputs to be worked when video loss is occurred to cam 1. Please check a check box of use column on Alarm Out box. More than two alarm outputs can be set. If Click (↔) 'All' of use box, all items are checked/unchecked at once
 - ⑪ Select cameras for preset when video loss is occurred to cam 1. Please check a check box of use column on Preset box. More than two cameras can be set. If Click (↔) 'All' of use box, all items are checked/unchecked at once
 - ⑫ Click (↔) Drop-down list of Preset to change Cameras preset. If Click (↔) Drop-down list of all preset box, all items are changed at once
 - ⑬ Select group for notification when video loss is occurred to cam 1. Please check a check box of E-Mail box. More than two Groups can be set.
- Repeat the above procedure for Cam 2 ~ Cam 16.
- Click (↔) Copy to All CH button to copy Notification to all channels.
- Click Beep Off to deactivate alert sounds from video loss. Apply to all channels.

5. OPERATION INSTRUCTION

5.1 Viewing

5.1.1 First Image

- Power on DVR and the attached cameras (if any) will display.

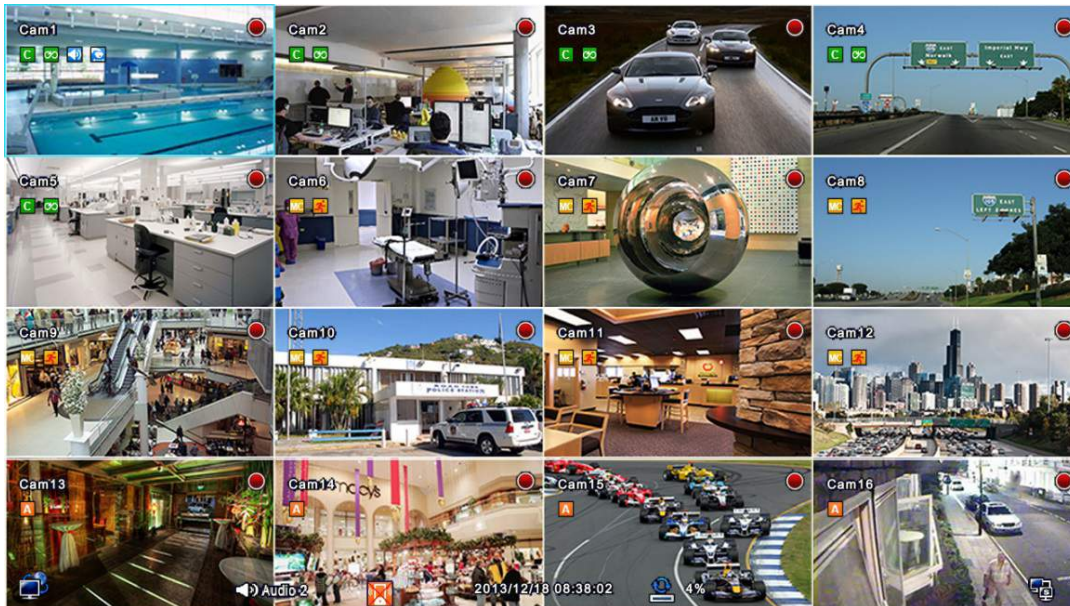

- The screen will display date/time and icons below.

Icon	Description	Icon	Description
	Continuous recording schedule		Continuous + Motion recording schedule
	Motion recording schedule		Motion + Alarm recording schedule
	Alarm recording schedule		Cont. + Motion + Alarm recording schedule
	Continuous + Alarm recording schedule		No Record
	Continuous recording mode		Motion recording mode
	Alarm recording mode		Emergency recording mode
	Audio recording		PTZ registration
	In recording		Remote access indication/ No. of accesses (up to 16)
	In channel sequencing		Audio channel
	Master Alarm Enabled		Date / Time
	HDD Overwriting Enabled		HDD Overwriting Disabled (Recording)
	Estimated HDD usage		Keyboard controller mode
	PTZ mode		Spot out Enabled

• On the right bottom side of the screen, disk usage will show by %.

• On the left top side of each channel screen   icon will show as its operation.

• At the normal state, HDD Overwrite mode is on and  icon shows.

• When Overwrite mode is off at **DEVICE>STORAGE>Overwrite**,  will show.

• Click Emergency recording button,  icon will show.

• Click Audio button,  icon will show. And Click Audio button again to reactivate the Audio.

NOTE

Note that the audio on/off is NOT for RECORDING. This button selection is for Audio out to DVR's 'Line/Speaker Out'.

5.1.2 View Format

• The available view formats when the Main Monitor is in viewing mode include Full Screen (Single channel View), Split Screen, Channel Sequencing Screen and PIP screen.

– **Full Screen:** Please press camera select key (1~16) to view the corresponding camera image in full view format.

NOTE

Using a mouse: Double Click to view the corresponding camera image in full view format and Double Click again to back to Split Screen.

– **Split Screen:** Please press **DISPLAY** key  and the available split screens (or multi-window view formats) will display alternately (i.e., 1, 4, 8, 9, 10, 16).

– **Channel Sequencing:** Please press **SEQUENCE** key  to display images in sequencing view format periodically. This automatic sequence function is not limited to the full screen format, but can be used in any view mode. In 8 channels DVR, 1 or 4-camera sequencing view mode is possible and in 16 channels DVR, 1, 4, 8, 9 or 10-camera sequencing view modes are possible.

5.1.3 Digital Zoom

- Select a Channel into Full Screen.
- Drag a portion to zoom by mouse.
- Double Click mouse to exit zoomed screen.
- This function works only in the full screen. A user cannot use the digital zoom function in split screen format, channel sequencing or PIP mode.

5.1.4 Freeze Live Image







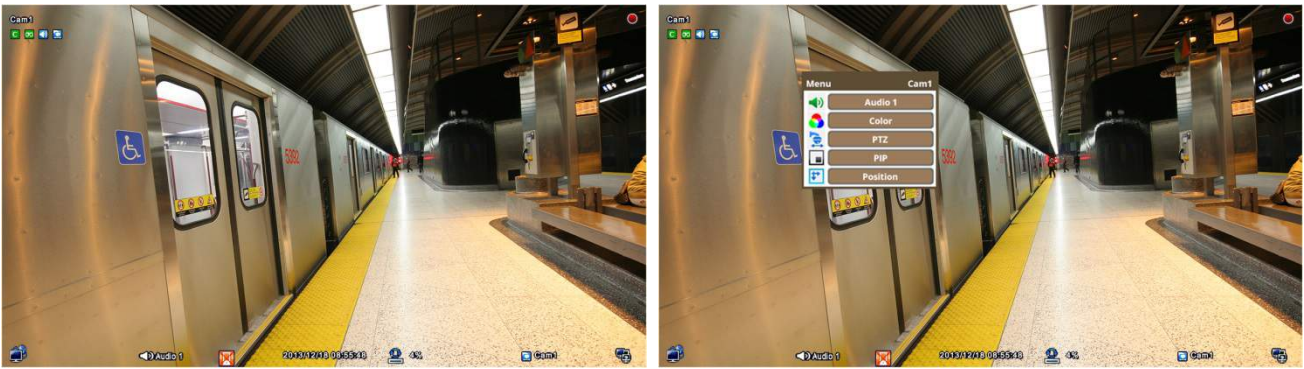





- Press **FREEZE** key  while viewing live image to pause the image.
- The Freeze function works only in the full screen or split screen formats. Please do not use this function in channel sequencing mode or in PIP mode.

5.1.5 Pan / Tilt / Zoom Control

- Press **PTZ** key to operate a PTZ camera connected to DVR. PTZ operations are only available in the full screen format.

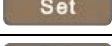

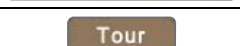

- In Pan/Tilt mode, the  icon is displayed on the bottom of the screen.
- Please refer the below for PTZ OSD menu.

Key	Function
   	Up/Down/Left/Right rotation
	Zoom out
	Zoom in
	Focus Far
	Focus Near
	Iris Close
	Iris Open
	Save Preset
	Go to the Preset
	Go to OSD main menu
	Run Group Tour 1~9
	Run Pattern 1~9

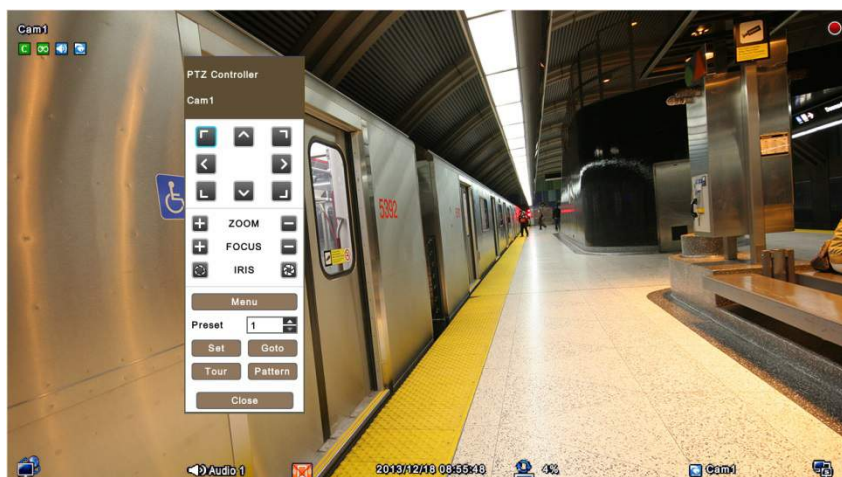
- To use a mouse in Pan/Tilt mode, select and double click a channel first. Right Click on selected channel to open Channel menu then Click “PTZ” to activate PTZ control OSD menu. A key pad control will show as follows:



- To add new preset, select Preset No and  button Click.
- To move to preset, select preset No and  button Click.

- Available 1 ~ 255 Preset numbers can be saved it depends on camera specification.
- Press Menu button to pop-up PTZ camera OSD setup screen and set up Tour and Pattern items.
 - Since these functions make use of a memory function of the camera itself, a user should set them in Camera OSD.
 - Once a user completes the setup, close the Camera OSD menu.
 - A user can conveniently use Tour and Pattern functions simply by Clicking Tour and Pattern buttons.
 - Please refer the PTZ camera manual for instruction of Tour and Pattern.

NOTE

Suppose a command for using Tour function is 71 ~ 79 + Preset and if you had set Tour to 70 (See Section 4.3.5), use Preset No: 1 ~ 9 + Tour button to activate the Tour function (70 + 1~9).

NOTE

It is required to set Menu as Preset number 95 from camera in order to call camera menu display by Clicking 'menu' button or using 95+Goto button. Please refer the PTZ camera manual for details.

5.1.6 System Log

- Please Press  key and the System Log screen will display.



Index	Date / Time	Type	Description	User ID
01	2013/12/18 10:11:12	SYSTEM	NTP Sync : Failure	system
02	2013/12/18 09:11:12	SYSTEM	NTP Sync : Failure	system
03	2013/12/18 08:38:03	CAMERA	Video Loss Occurred	system
04	2013/12/18 08:37:51	CAMERA	Video Loss Occurred	system
05	2013/12/18 08:37:36	CAMERA	Video Loss Occurred	system
06	2013/12/18 08:37:06	SETUP	Setup Exit	admin
07	2013/12/18 08:26:12	CAMERA	Video Loss Occurred	system
08	2013/12/18 08:11:12	SYSTEM	NTP Sync : Failure	system
09	2013/12/18 07:46:48	SETUP	Setup Enter	admin
10	2013/12/18 07:29:48	SYSTEM	System Start	system
11	2013/12/18 07:14:32	SETUP	Setup Enter	admin
12	2013/12/18 07:11:20	SYSTEM	System Start	system
13	2013/12/18 06:40:21	SETUP	Setup Enter	admin
14	2013/12/18 06:40:08	SETUP	Setup Exit	admin

Buttons: Delete, Export, Close

Warning: Please connect USB first to copy the LOG file

- System Event shows all logs of actions taken by users.



5.1.7 Key Lock

- Press  to operate the key lock function. This function is indicated by  icon in the center of the screen.
- Once the Key Lock function is activated, a user cannot use any key. If wish to use a key, please enter the correct password to release the key lock function.

5.1.8 Emergency Recording

- When a user presses **EMERGENCY** key or , recording starts right away regardless of the recording mode. A user can modify the Emergency recording conditions. **SETUP> RECORD > EMERGENCY**

5.1.9 Alarm Out Control and Acknowledge





- Press  and will be able to activate Acknowledge or Open Alarm out Control.
- Press  to instantly disable Alarm out signal.
- Press  to open alarm out control window to manually activate Alarm out.

5.2 Playback



- Press  key on the System Menu Bar, or Press Search button on the front of the DVR and the following Search menu will display.



- There are two ways to search video, i.e., by Calendar and by event.
 - Calendar Search: search by using calendar.
 - Event Search: search by event.
- There are three other functions in playback mode;
 - : This function allows a user to take screenshot and save to USB in jpeg format.
 - : The Archive function allows a user to copy the recorded video in EXE or AVI format to a storage device (USB memory stick or DVD-RW). Refer to **5.5 Archive** for more information
 - : Able to access the saved Bookmarks and play the data from the marked time. Refer to **5.4 Bookmark** for more information.
 - : Able to show the color coding of the time bar. Each color represents different recording mode.



- Playback mode runs in the available maximum number of split screen format. To change the viewing mode, please press **DISPLAY** key or **Camera Select** key (1~16).









NOTE

Using a mouse: Double Click to view the full screen and double Click one more time to back to Split Screen.

NOTE

Pushing a wheel of mouse: Enter Playback mode.

• Following is the key usage found in playback mode. A user may also use the keypad provided on the screen.

Go to Start		• Go to start of recorded data
REW		• Fast backward playback (changes up to x128 with each press)
BACKWARD		• Frame-by-frame reverse still image playback
PLAY		• Playback mode: 1X PLAY
PAUSE		• PAUSE
FORWARD		• Frame-by-frame forward still image playback
FF		• Fast forward playback (changes up to x128 with each press)
Go to End		• Go to end of the recorded data



• Press key to leave the playback mode.

5.2.1 Search



• Press key on the System Menu Bar, or Press Search button on the front of the DVR and the following Search menu will display.



- There are two ways to search video, i.e., by calendar and by event.
 - **Calendar Search:** search by using calendar.
 - **Event Search:** search by event.

Calendar Search

• As enter Search mode following will display.



- Please Click (+) Calendar to do Calendar Search. (Default display)
- Dates and Time with recorded data available will be high-lighted in Red color.

• Follow the procedure below to search video by calendar.

- ① Select Year and Month by using the arrow buttons in the calendar.
 - ►►: Move to next 'Year'
 - ◀◀: Move to previous 'Year'
 - ►: Move to next 'Month'
 - ◀: Move to previous 'Month'
- ② Click (↔) on a certain date wish to playback. The date will be displayed in Blue color.
- ③ Click (↔) on the time bar and Red line will move to the selected time and playback will begin instantly.

NOTE

Time period on the time indication bar can be adjusted by mouse **scroll**. It can be adjusted by 1 min to 3 hour time duration blocks.



• If you don't use mouse or front button while the DVR is playing recorded data, the DVR would stop playback in 10 minutes automatically.

Event Search

• This Event Search is useful when a user set up event recording like Motion, Alarm In (if any), Text In (if any), and Emergency.

• Please Click (↔)  to do Event Search.

• Press  on the side and the following Date / Time Setup menu will display.

Date / Time Setup

Date: 2013/12/17 ~ 2013/12/18

Time: 04:14:44 ~ 04:14:44

CH01 CH02 CH03 CH04 CH05 CH06 CH07 CH08
 CH09 CH10 CH11 CH12 CH13 CH14 CH15 CH16

Event Search POS/ATM Search

Motion Alarm Emergency

- ① Select Event Search start Date and Time.
- ② Select Event Search end Date and Time.
- ③ Select cameras (video) to be included. One or more cameras can be selected.
- ④ Choose 'Event Search' and select specific event(s) to be included. Or choose 'POS/ATM Search' then virtual keypad is display. Type a keyword to search by.
- ⑤ Click "OK" to search the recorded data for selected event and key word transactions.
- ⑥ Searched data will be listed on the side.

NOTE

When selecting camera, more the one camera can be selected.

5.2.2 Digital Zoom in Playback

- Users are able to use Digital Zoon function in full screen playback.
- Drag a partition on to the screen, then the partition will enlarge as a full screen.
- Double Click the left button of mouse to exit the zoom-in screen.

5.2.3 One-touch Playback

- Press the **PLAY/PAUSE** key or Click the mouse wheel (central button) in the viewing mode. Then, a user will be able to view the recorded video right away without going through the search procedure. The video plays back the recorded video from the last three minutes. To stop playing back the video, please press  key.

5.3 Menu Bar

















- Menu bar enables users to control all features as front button.



- Move mouse cursor to Left and Right margin of the screen to access Menu Bar during live monitoring.

Display Menu Bar (Left Margin)

System Menu Bar (Right Margin)



Icon	Description	Icon	Description
	Main monitor Display (1/4/8/9/10/16)		General Status
	Activate Sequencing mode (1/4/8/9/10)		Open Event Log
	Multi Spot (1/4/8/9/10/16/None)		Enter Setup mode
	Disable Alarm out / Alarm Out control		Enter Search Mode
	OSD On / Off		Enter Archive mode
	Freeze Live Image		Activate Key Lock
	Bookmark		System Restart
	Activate Emergency recording		System Shut Down

5.4 Bookmark

- Bookmark allows a user to save certain time during both live monitoring and playback mode. And able to go back to the bookmarked time during playback.

- Press  in both Live and Playback mode and the following popup window will display.



- In Live, it is only possible to add the current time to the list. Please enter Name for each of the Bookmark time. A user can check the list in playback.
- In Playback, it is possible to add, delete and play from the Bookmark List. Press  to add the current (in playing) time to the list. Press  to delete added bookmark from the Bookmark List. To do playback double Click on the bookmarked time from the list.

5.5 Archive





- The Archive function allows a user to copy the recorded video from DVR to a storage device (USB memory stick, DVD-RW).
- Please execute Archive at both Live and Playback.
- Follow the procedure.

- ① Press **ARCHIVE**  key during live monitoring or  during Playback. Then, the following screen will display.

Archive

CH01
 CH02
 CH03
 CH04
 CH05
 CH06
 CH07
 CH08
 CH09
 CH10
 CH11
 CH12
 CH13
 CH14
 CH15
 CH16

From : Device :
 To : Format :
 File Name :

- ② Check a check box next to a camera with the video that want to store. A user can archive multi-channel at the same time. (only EXE format, one channel only for AVI format)
- ③ Click (←) the   on the right-hand side of FROM box to set the storage start time.
- ④ Click (←) the   on the right-hand side of TO box to set the storage end time.
- ⑤ Click (←) Format box to select EXE or AVI.
- ⑥ Click (←) Device box to select a storage device out of USB and CD/DVD-RW.
- ⑦ Click (←) the keyboard display on the right-hand side of File Name box to input a file name. A user does not need to input extension (exe, avi). Please note that the file is not going to be stored unless user inputs a name.
- ⑧ To set a Password to the file that users want to save, mark the check box of "use Password". Then, Click the keyboard button and set a password.
- ⑨ Click (←) OK button. Then, Progress bar will display and the storage process proceeds. The progress bar may not show actual progress time. Depending on the file size, it may restart even after it shows 100%. It is important not to detach storage device until DVR displays "Archive Success" or "Failure" message.
- ⑩ If the archiving is done properly, Archive Success message will pop up. Please choose 'OK' to confirm. If the storage fails, Archive Fail message will pop up. In this case, a user may try again.

NOTE

To archive in jpeg format please use snapshot in Playback mode.

NOTE

Please do not change the settings by DVR or CMS, while archiving.

NOTE

Please enter all the necessary information before Click 'OK'.

NOTE

If the total archiving file size exceeds 2GB then the new archived file will be produced every 2GB. From the second file it will have Date and time stamp of the starting time after the original file name given by the user.

If the total archiving file exceeds the capacity of the media then the popup message will display once the maximum capacity of the media is reached. Please change the media and press "OK" to proceed.

CAUTION

PLEASE DO NOT USE THE SPACE WHEN ENTER BACKUP FILE NAME.

CAUTION

DURING ARCHIVE PROCEDURE, PLEASE DO NOT DETACH STORAGE DEVICE OR POWER OFF THE DVR. OTHERWISE, IT MAY CAUSE PERMANENT DAMAGE TO THE DVR OR THE STORAGE DEVICE. IN SUCH CASE, A USER MUST REBOOT THE DVR. IF THE DVR DOES NOT OPERATE PROPERLY, A USER MIGHT NEED TO CONTACT SERVICE CENTER.

CAUTION

WHEN ARCHIVING IN AVI FORMAT, IT ONLY SUPPORTS 1CH AND DOES NOT SUPPORT PASSWORD FEATURES.